



LAPAROSKOPISCHE INSTRUMENTE
LAPAROSCOPIC INSTRUMENTS

INHALT | CONTENTS

1	WIEDERVERWENDBARE INSTRUMENTENLINIE REUSABLE INSTRUMENT LINE	
XPRESS LOCK ®	Fakten & Vorteile <i>Facts & Features</i>	4
	Schäfte <i>Sheaths</i>	5
	Griffe <i>Handles</i>	5
2	EINSÄTZE FÜR XPRESS LOCK® INSERTS FOR XPRESS LOCK®	
CERAMIX CUT ®	Fakten & Vorteile <i>Facts & Features</i>	6
STANDARD	Greifzangen <i>Grasping forceps</i>	7
	Dissektionszangen <i>Dissecting forceps</i>	25
	Scheren <i>Scissors</i>	29
	Nadelhalter <i>Needleholders</i>	32
	Biopsiestanzen <i>Biopsy punches</i>	34
	Biopsielöffel <i>Biopsy spoons</i>	34
3	HYBRID INSTRUMENTE HYBRID INSTRUMENTS	
TI-LINE ®	Fakten & Vorteile <i>Facts & Features</i>	36
	Maulteile <i>Tips</i>	37
	Schaft-Griff Teile <i>Sheath-handle parts</i>	37
FUTURE LAP ®	Fakten & Vorteile <i>Facts & Features</i>	38
	Maulteile-Schaft Teile <i>Tip-sheath parts</i>	39
	Griffe <i>Handles</i>	40
4	EINWEGINSTRUMENTE SINGLE-USE INSTRUMENTS	
	Fakten & Vorteile <i>Facts & Features</i>	42
	Einweginstrumente <i>Single-use instruments</i>	43
5	BIPOLARE INSTRUMENTENLINIEN BIPOLAR INSTRUMENT LINES	
PREMIUM	Griff <i>Handle</i>	44
	Schaft <i>Sheath</i>	44
	Einsätze <i>Inserts</i>	44
STANDARD	Griff <i>Handle</i>	45
	Schaft <i>Sheath</i>	45
	Einsätze <i>Inserts</i>	45
ECONOMY	Federhandgriff-Instr. <i>Spring-handle instr.</i>	46
6	LAPAROSKOPISCHES ZUBEHÖR LAPAROSCOPIC ACCESSORIES	
SYSTEM ADG ®		47
SYSTEM DG ®		48
	Anvil Greifer <i>Anvil grasper</i>	48
PISTOLENGRIFF NH. PISTOL GRIP NEEDLEHOLDERS		49
	ETH Nadelhalter <i>ETH Needleholders</i>	50
FASCIA INSTR. FASCIA CLOSING DEVICES		51
FLEXIBLE RETRAKTOREN SNAKE RETRACTORS		52
	Weitere Retraktoren <i>Additional retractors</i>	53
	LL Injektionsnadeln <i>LL injection needles</i>	54
	Knotenschieber <i>Knot pushers</i>	55
	Ring Applikatoren <i>Ring applicators</i>	55
7	KABEL CABLES	
	Monopolare Kabel <i>Monopolar cables</i>	56
	Bipolare Kabel <i>Bipolar cables</i>	56
8	ALPHANUMERISCHER INDEX ALPHANUMERIC INDEX	
	Alphanumerischer Index <i>Alphanumeric Index</i>	58

KENNZEICHNUNGEN | SYMBOLS

ERLÄUTERUNG ZU SYMBOLEN | EXPLANATION OF SYMBOLS

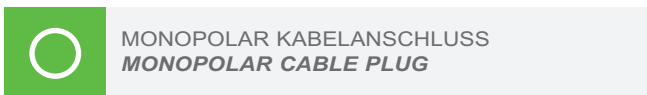
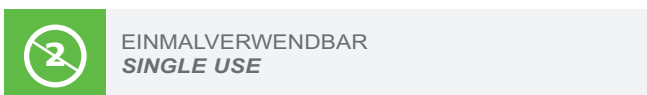
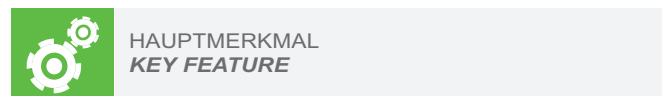

XPRESS LOCK® ★

FAKTEN & VORTEILE | FACTS & FEATURES

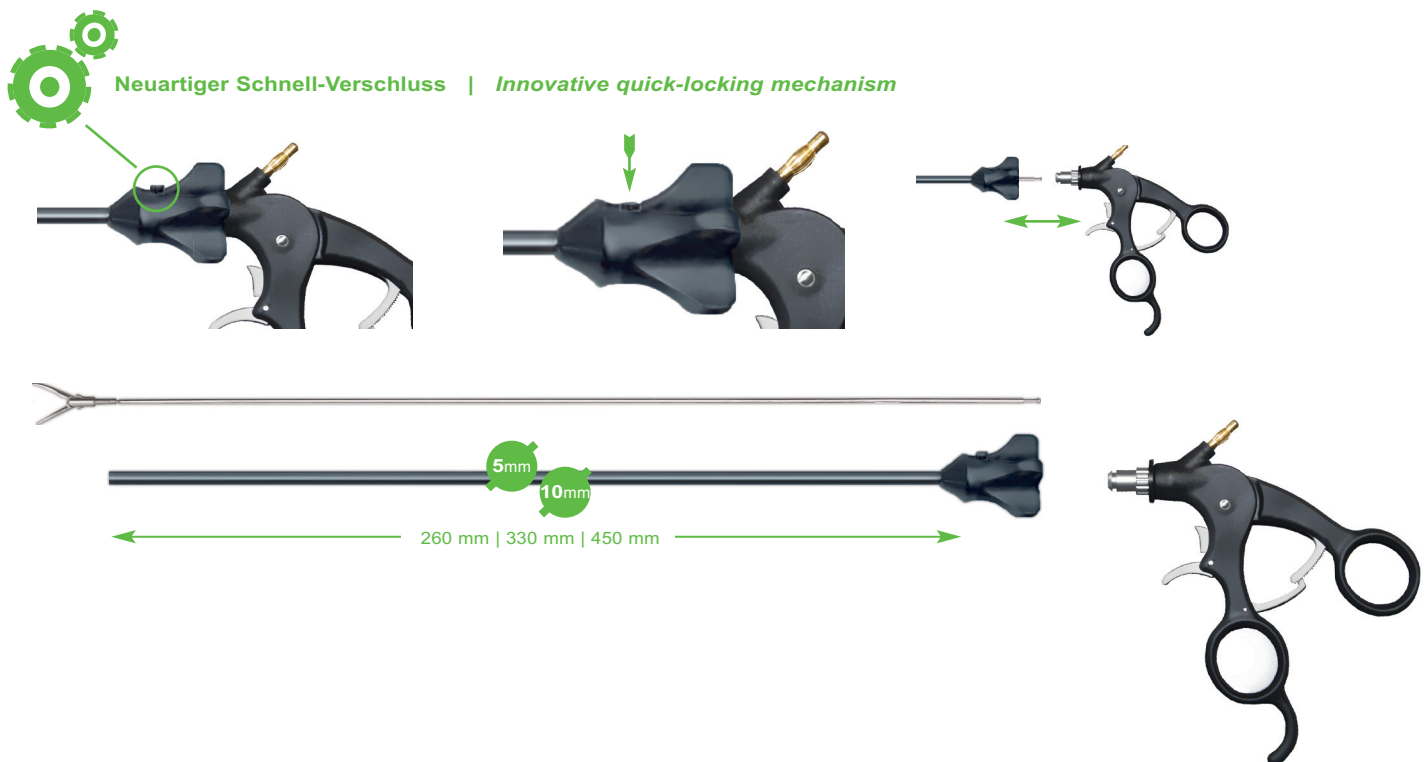

- ▶ Neuestes Instrumentensystem mit Schnell-Verschluss
- ▶ Innovatives Griffdesign für On-Off Action
- ▶ Autoklavierbar
- ▶ Längen von 260, 330 und 450 mm
- ▶ 360° rotierbar mit hör- und fühlbarem Feedback
- ▶ Zerlegbar in Griff, Schaft und Einsatz
- ▶ Ergonomische Handgriffe in verschiedenen Ausführungen für jeden Chirurgen
- ▶ Keine versteckten Flächen für Ablagerungen von Blut und Geweberesten
- ▶ Zeitsparende und unkomplizierte Reinigung dank Schnell-Verschluss
- ▶ Kosteneffizient - Design verringert Kosten pro Anwendung
- ▶ Kein Lager notwendig im Vergleich zu Einweginstrumenten

- ▶ Latest instrument system with quick-locking mechanism
- ▶ Innovative ratchet design for on-off-action
- ▶ Autoclavable
- ▶ Lengths of 260, 330 and 450 mm
- ▶ 360° rotatable with audible and tactile feedback
- ▶ Demountable into handle, sheath and insert
- ▶ Most ergonomic handles in different designs for every surgeon's physique
- ▶ No hidden spaces for blood and debris deposits
- ▶ Time saving due to easy cleaning and assembly
- ▶ Cost effective - design reduces cost per case and
- ▶ Virtually no stock if compared to disposable instruments

XPRESS LOCK © ★

SCHÄFTE | SHEATHS

	13-1356XP-26	260 mm		<p>Schaft für XPress Lock® Einsätze <i>Sheath</i> for XPress Lock® inserts</p>
	13-1356XP	330 mm		
	13-1356XP-45	450 mm		
	13-1357XP-26	260 mm		
	13-1357XP	330 mm		
	13-1357XP-45	450 mm		

GRIFFE | HANDLES



13-1367XP	<p>Ohne Sperre <i>Non-ratchet</i></p>	<p>XPress Lock® Kohlefaserhandgriff - ergonomisch <i>XPress Lock® carbon fiber handle - ergonomic</i></p>
13-1368XP	<p>On-Off Sperre <i>On-Off ratchet</i></p>	

ÜBER | ABOUT CERAMIX CUT © ★

KERAMIKBESCHICHTETE SCHERENEINSÄTZE | CERAMIC COATED SCISSOR INSERTS

FAKTEN & VORTEILE | FACTS & FEATURES



Innovative Keramikbeschichtung | Innovative ceramic coating

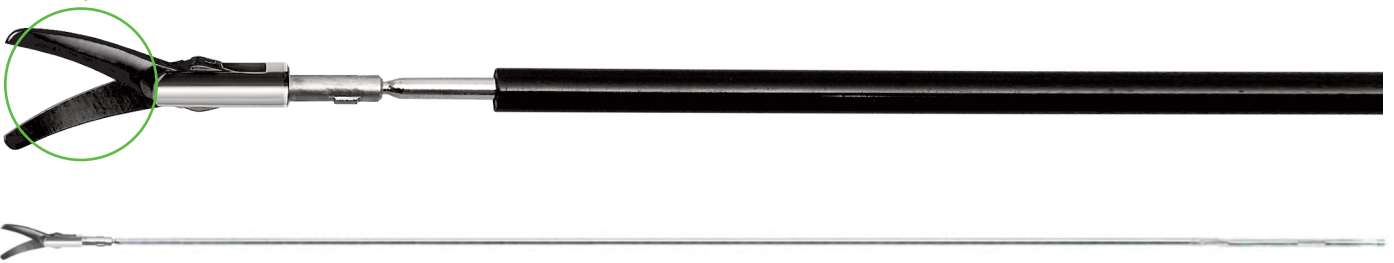

- ▶ Verschleißfest
 - ▶ Verminderter Abrieb
 - ▶ Kosteneffizient durch langzeitstabile Oberfläche
 - ▶ Minimale optische Reflexion
 - ▶ Robust
 - ▶ Rost- und korrodierungsfrei
 - ▶ Temperatur- und kratzbeständig
 - ▶ Hervorragende Schneidfähigkeit
 - ▶ 3 bis 5fache Härte gegenüber gehärtetem Metall
 - ▶ Glatte, dichte Struktur - leicht zu reinigende Oberfläche
 - ▶ Beständiger gegenüber Reinigungs- und Desinfektionsmittel
 - ▶ Verbesserte Gleiteigenschaft, dadurch weicher und gleichmäßiger Gang der Scherenblätter
 - ▶ Geeignet zur Verwendung mit XPress Lock ©
- ▶ Wear-resistant
 - ▶ Reduced abrasion
 - ▶ Cost-effective due to long-term stable surface
 - ▶ Minimal optical reflection
 - ▶ Solid
 - ▶ Stainless and non-corrosive
 - ▶ Temperature- and scratch-resistant
 - ▶ Outstanding cutting ability
 - ▶ 3 to 5 times harder than hardened metal
 - ▶ Smooth and dense surface - easily cleanable
 - ▶ More resistant to detergents and disinfectants
 - ▶ Improved sliding characteristics, therefore slighter movement of the scissor blades
 - ▶ Suitable for the use with XPress Lock ©

XPRESS LOCK® EINSÄTZE | INSERTS

GREIFZANGEN | GRASPING FORCEPS



Gefensterte Greifzange, Mikromaulteil
Fenestrated grasping forceps, micro jaw

14mm

**WIR EMPFEHLEN
WE RECOMMEND**



Schaft
sheath

&



Griff mit Sperre
handle *with ratchet*

XPRESS LOCK®	260 mm	330 mm	450 mm
	13-1379XPI-26	13-1379XPI	13-1379XPI-45



★ Gefensterte Greifzange, flache Maulseite
Fenestrated grasping forceps, slightly flat jaws

20mm

**WIR EMPFEHLEN
WE RECOMMEND**



Schaft
sheath

&



Griff mit Sperre
handle *with ratchet*

XPRESS LOCK®	260 mm	330 mm	450 mm
	13-1301XPI-26	13-1301XPI	13-1301XPI-45



Gefensterte Greifzange, 5 x 20 mm, rund, Querzähne
Fenestrated grasper, 5 x 20 mm, round, cross serrations

20mm

**WIR EMPFEHLEN
WE RECOMMEND**



Schaft
sheath

&



Griff mit Sperre
handle *with ratchet*

XPRESS LOCK®	260 mm	330 mm	450 mm
	13-1382XPI-26	13-1382XPI	13-1382XPI-45



★ Endo Clinch, mit extrem atraumatischer Verzahnung
Endo Clinch, extremely atraumatic serrated

23mm

**WIR EMPFEHLEN
WE RECOMMEND**



Schaft
sheath

&





Griff mit Sperre
handle *with ratchet*

XPRESS LOCK®	260 mm	330 mm	450 mm
	13-1323XPI-26	13-1323XPI	13-1323XPI-45

XPRESS LOCK[®] EINSÄTZE | INSERTS

GREIFZANGEN | GRASPING FORCEPS

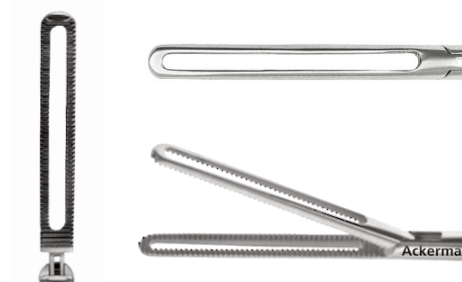
	<p>★ Gefensterierte Klemme <i>Fenestrated clamp</i></p> <p style="text-align: right;">40mm</p>				
	<p>WIR EMPFEHLEN <i>WE RECOMMEND</i></p> <p>5mm Schaft sheath & Griff mit Sperre handle <i>with ratchet</i></p>				
	<table border="1"> <tr> <td>XPRESS LOCK[®]</td> <td>260 mm 13-1343XPI-26</td> <td>330 mm 13-1343XPI</td> <td>450 mm 13-1343XPI-45</td> </tr> </table>	XPRESS LOCK[®]	260 mm 13-1343XPI-26	330 mm 13-1343XPI	450 mm 13-1343XPI-45
XPRESS LOCK[®]	260 mm 13-1343XPI-26	330 mm 13-1343XPI	450 mm 13-1343XPI-45		
	<p>Johan Greifzange, flache Maulteile <i>Johan grasping forceps, slightly flat jaws</i></p> <p style="text-align: right;">15mm</p>				
	<p>WIR EMPFEHLEN <i>WE RECOMMEND</i></p> <p>5mm Schaft sheath & Griff mit Sperre handle <i>with ratchet</i></p>				
	<table border="1"> <tr> <td>XPRESS LOCK[®]</td> <td>260 mm 13-1311XPI-26</td> <td>330 mm 13-1311XPI</td> <td>450 mm 13-1311XPI-45</td> </tr> </table>	XPRESS LOCK[®]	260 mm 13-1311XPI-26	330 mm 13-1311XPI	450 mm 13-1311XPI-45
XPRESS LOCK[®]	260 mm 13-1311XPI-26	330 mm 13-1311XPI	450 mm 13-1311XPI-45		
	<p>★ Johan Greifzange, flache Maulteile <i>Johan grasping forceps, slightly flat jaws</i></p> <p style="text-align: right;">22mm</p>				
	<p>WIR EMPFEHLEN <i>WE RECOMMEND</i></p> <p>5mm Schaft sheath & Griff mit Sperre handle <i>with ratchet</i></p>				
	<table border="1"> <tr> <td>XPRESS LOCK[®]</td> <td>260 mm 13-1312XPI-26</td> <td>330 mm 13-1312XPI</td> <td>450 mm 13-1312XPI-45</td> </tr> </table>	XPRESS LOCK[®]	260 mm 13-1312XPI-26	330 mm 13-1312XPI	450 mm 13-1312XPI-45
XPRESS LOCK[®]	260 mm 13-1312XPI-26	330 mm 13-1312XPI	450 mm 13-1312XPI-45		
	<p>Johan Greifzange, flache Maulteile <i>Johan grasping forceps, slightly flat jaws</i></p> <p style="text-align: right;">40mm</p>				
	<p>WIR EMPFEHLEN <i>WE RECOMMEND</i></p> <p>5mm Schaft sheath & Griff mit Sperre handle <i>with ratchet</i></p>				
	<table border="1"> <tr> <td>XPRESS LOCK[®]</td> <td>260 mm 13-1313XPI-26</td> <td>330 mm 13-1313XPI</td> <td>450 mm 13-1313XPI-45</td> </tr> </table>	XPRESS LOCK[®]	260 mm 13-1313XPI-26	330 mm 13-1313XPI	450 mm 13-1313XPI-45
XPRESS LOCK[®]	260 mm 13-1313XPI-26	330 mm 13-1313XPI	450 mm 13-1313XPI-45		

XPRESS LOCK® EINSÄTZE | INSERTS

GREIFZANGEN | GRASPING FORCEPS



Tumor-Greifzange, stumpfes Ende
Tumor graspers, blunt end

17mm

**WIR EMPFEHLEN
WE RECOMMEND**



Schaft
sheath

&



Griff **ohne** Sperre
handle **w/o** ratchet

XPRESS LOCK®	260 mm	330 mm	450 mm
	13-1300XPI-26	13-1300XPI	13-1300XPI-45



Greifzange, atraumatisch gezahnt
Grasping forceps, atraumatic serrated

28mm

**WIR EMPFEHLEN
WE RECOMMEND**



Schaft
sheath

&



Griff **mit** Sperre
handle **with** ratchet

XPRESS LOCK®	260 mm	330 mm	450 mm
	13-1377XPI-26	13-1377XPI	13-1377XPI-45



Maxi Fundus Greifzange, maximaler Halt
Maxi Fundus type graspers, maximized grip

20mm

**WIR EMPFEHLEN
WE RECOMMEND**



Schaft
sheath

&



Griff **mit** Sperre
handle **with** ratchet

XPRESS LOCK®	260 mm	330 mm	450 mm
	13-1302XPI-26	13-1302XPI	13-1302XPI-45



Starke Greifzange, doppelbewegliche Ausführung
Strong graspers, double action version

15mm

**WIR EMPFEHLEN
WE RECOMMEND**



Schaft
sheath

&







Griff **mit** Sperre
handle **with** ratchet

XPRESS LOCK®	260 mm	330 mm	450 mm
	13-1303XPI-26	13-1303XPI	13-1303XPI-45

XPRESS LOCK[®] EINSÄTZE | INSERTS

GREIFZANGEN | GRASPING FORCEPS

	<p>Starke Greifzange, einfach bewegliche Ausführung <i>Strong graspers, single action version</i></p> <p style="text-align: right;">15mm</p>				
	<p>WIR EMPFEHLEN <i>WE RECOMMEND</i></p> <p>5mm Schaft sheath & Griff mit Sperre handle <i>with ratchet</i></p>				
	<table border="1"> <tr> <td>XPRESS LOCK[®]</td> <td>260 mm 13-1600XPI-26</td> <td>330 mm 13-1600XPI</td> <td>450 mm 13-1600XPI-45</td> </tr> </table>	XPRESS LOCK[®]	260 mm 13-1600XPI-26	330 mm 13-1600XPI	450 mm 13-1600XPI-45
XPRESS LOCK[®]	260 mm 13-1600XPI-26	330 mm 13-1600XPI	450 mm 13-1600XPI-45		
	<p>Alligator Greifzange <i>Alligator grasping forceps</i></p> <p style="text-align: right;">14mm</p>				
	<p>WIR EMPFEHLEN <i>WE RECOMMEND</i></p> <p>5mm Schaft sheath & Griff mit Sperre handle <i>with ratchet</i></p>				
	<table border="1"> <tr> <td>XPRESS LOCK[®]</td> <td>260 mm 13-1330XPI-26</td> <td>330 mm 13-1330XPI</td> <td>450 mm 13-1330XPI-45</td> </tr> </table>	XPRESS LOCK[®]	260 mm 13-1330XPI-26	330 mm 13-1330XPI	450 mm 13-1330XPI-45
XPRESS LOCK[®]	260 mm 13-1330XPI-26	330 mm 13-1330XPI	450 mm 13-1330XPI-45		
	<p>★ Standard Greifer, mit Querzähnen <i>Standard grasper, cross serrated</i></p> <p style="text-align: right;">18mm</p>				
	<p>WIR EMPFEHLEN <i>WE RECOMMEND</i></p> <p>5mm Schaft sheath & Griff mit Sperre handle <i>with ratchet</i></p>				
	<table border="1"> <tr> <td>XPRESS LOCK[®]</td> <td>260 mm 13-1354XPI-26</td> <td>330 mm 13-1354XPI</td> <td>450 mm 13-1354XPI-45</td> </tr> </table>	XPRESS LOCK[®]	260 mm 13-1354XPI-26	330 mm 13-1354XPI	450 mm 13-1354XPI-45
XPRESS LOCK[®]	260 mm 13-1354XPI-26	330 mm 13-1354XPI	450 mm 13-1354XPI-45		
	<p>Reddick Greifer <i>Reddick grasper</i></p> <p style="text-align: right;">18mm</p>				
	<p>WIR EMPFEHLEN <i>WE RECOMMEND</i></p> <p>5mm Schaft sheath & Griff mit Sperre handle <i>with ratchet</i></p>				
	<table border="1"> <tr> <td>XPRESS LOCK[®]</td> <td>260 mm 13-1335XPI-26</td> <td>330 mm 13-1335XPI</td> <td>450 mm 13-1335XPI-45</td> </tr> </table>	XPRESS LOCK[®]	260 mm 13-1335XPI-26	330 mm 13-1335XPI	450 mm 13-1335XPI-45
XPRESS LOCK[®]	260 mm 13-1335XPI-26	330 mm 13-1335XPI	450 mm 13-1335XPI-45		

XPRESS LOCK® EINSÄTZE | INSERTS

GREIFZANGEN | GRASPING FORCEPS



Duckbill Greifzange, quergezahnt
Duckbill forceps, cross serrated

13mm

WIR EMPFEHLEN
WE RECOMMEND



Schaft sheath

&



Griff mit Sperre handle with ratchet

XPRESS LOCK®	260 mm	330 mm	450 mm
	13-1421XPI-26	13-1421XPI	13-1421XPI-45



Greifzange, gerundete Maulteile
Grasping forceps, rounded jaws

15mm

WIR EMPFEHLEN
WE RECOMMEND



Schaft sheath

&



Griff mit Sperre handle with ratchet

XPRESS LOCK®	260 mm	330 mm	450 mm
	13-1305XPI-26	13-1305XPI	13-1305XPI-45



Greifer, mit Löffel
Grasper, with spoon

16mm

WIR EMPFEHLEN
WE RECOMMEND



Schaft sheath

&



Griff ohne Sperre handle w/o ratchet

XPRESS LOCK®	260 mm	330 mm	450 mm
	13-1310XPI-26	13-1310XPI	13-1310XPI-45



Greifzange, gezahnt
Grasping forceps, serrated

25mm

WIR EMPFEHLEN
WE RECOMMEND



Schaft sheath

&



Griff ohne Sperre handle w/o ratchet

XPRESS LOCK®	260 mm	330 mm	450 mm
	13-1378XPI-26	13-1378XPI	13-1378XPI-45

XPRESS LOCK[®] EINSÄTZE | INSERTS

GREIFZANGEN | GRASPING FORCEPS



Greifzange, mit Löffel, spitze Version
Grasper, with spoon, pointed version

14mm

**WIR EMPFEHLEN
WE RECOMMEND**



Schaft
sheath

&



Griff **ohne** Sperre
handle **w/o** ratchet

XPRESS LOCK[®]

260 mm

13-1315XPI-26

330 mm

13-1315XPI

450 mm

13-1315XPI-45



Delphinmaul, kurze Ausführung
Dolphin nose, short version

18mm

**WIR EMPFEHLEN
WE RECOMMEND**



Schaft
sheath

&



Griff **ohne** Sperre
handle **w/o** ratchet

XPRESS LOCK[®]

260 mm

13-1409XPI-26

330 mm

13-1409XPI

450 mm

13-1409XPI-45



Delphinmaul, lange Ausführung
Dolphin nose, long version

25mm

**WIR EMPFEHLEN
WE RECOMMEND**



Schaft
sheath

&



Griff **ohne** Sperre
handle **w/o** ratchet

XPRESS LOCK[®]

260 mm

13-1416XPI-26

330 mm

13-1416XPI

450 mm

13-1416XPI-45



Kocher, 1 x 2 Zähne
Kocher, 1 x 2 teeth

18mm

**WIR EMPFEHLEN
WE RECOMMEND**



Schaft
sheath

&



Griff **mit** Sperre
handle **with** ratchet

XPRESS LOCK[®]

260 mm

13-1350XPI-26

330 mm

13-1350XPI

450 mm

13-1350XPI-45



XPRESS LOCK® EINSÄTZE | INSERTS

GREIFZANGEN | GRASPING FORCEPS



Starke atraumatische Greifzange, gebogen
Strong atraumatic clamp, curved

40mm

WIR EMPFEHLEN
WE RECOMMEND



Schaft
sheath

&



Griff mit Sperre
handle with ratchet

XPRESS LOCK®	260 mm	330 mm	450 mm
	13-1324XPI-26	13-1324XPI	13-1324XPI-45



Starke atraumatische Greifzange, gerade
Strong atraumatic clamp, straight

40mm

WIR EMPFEHLEN
WE RECOMMEND



Schaft
sheath

&



Griff mit Sperre
handle with ratchet

XPRESS LOCK®	260 mm	330 mm	450 mm
	13-1327XPI-26	13-1327XPI	13-1327XPI-45



Atraumatischer Greifer, einfach beweglich
Atraumatic grasper, single action

15mm

WIR EMPFEHLEN
WE RECOMMEND



Schaft
sheath

&



Griff mit Sperre
handle with ratchet

XPRESS LOCK®	260 mm	330 mm	450 mm
	13-1325XPI-26	13-1325XPI	13-1325XPI-45



Atraumatischer Greifer, diamant gezahnt
Atraumatic grasper, diamond serrations

20mm

WIR EMPFEHLEN
WE RECOMMEND



Schaft
sheath

&



Griff mit Sperre
handle with ratchet

XPRESS LOCK®	260 mm	330 mm	450 mm
	13-1413XPI-26	13-1413XPI	13-1413XPI-45

XPRESS LOCK[®] EINSÄTZE | INSERTS

GREIFZANGEN | GRASPING FORCEPS



Scharfer atraumatischer Greifer Manhes, einfach bewgl.
Sharp atraumatic grasper Manhes, single action

13mm

WIR EMPFEHLEN
WE RECOMMEND



Schaft
sheath

&



Griff mit Sperre
handle with ratchet

XPRESS LOCK [®]	260 mm	330 mm	450 mm
	13-1326XPI-26	13-1326XPI	13-1326XPI-45



Allis atraumatische Greifzange, Hartmetall
Allis atraumatic grasper, TC inserted jaws

35mm

WIR EMPFEHLEN
WE RECOMMEND



Schaft
sheath

&



Griff mit Sperre
handle with ratchet

XPRESS LOCK [®]	260 mm	330 mm	450 mm
	13-1329XPI-26	13-1329XPI	13-1329XPI-45



Allis Faßzange, abgerundete Version
Allis grasping forceps, rounded version

35mm

WIR EMPFEHLEN
WE RECOMMEND



Schaft
sheath

&



Griff mit Sperre
handle with ratchet

XPRESS LOCK [®]	260 mm	330 mm	450 mm
	13-1337XPI-26	13-1337XPI	13-1337XPI-45



Allis, einfach beweglich, kurze Ausführung
Allis, single action, short version

15mm

WIR EMPFEHLEN
WE RECOMMEND



Schaft
sheath

&



Griff mit Sperre
handle with ratchet

XPRESS LOCK [®]	260 mm	330 mm	450 mm
	13-1350XPI-26	13-1350XPI	13-1350XPI-45

XPRESS LOCK® EINSÄTZE | INSERTS

GREIFZANGEN | GRASPING FORCEPS



Allis atraumatische Greifzange, 3 x 4 Zähne, doppelbewegl.
Allis atraumatic grasper, 3 x 4 teeth, double action

15mm

WIR EMPFEHLEN
WE RECOMMEND



Schaft sheath

&



Griff mit Sperre handle with ratchet

XPRESS LOCK®	260 mm	330 mm	450 mm
	13-1418XPI-26	13-1418XPI	13-1418XPI-45



Allis, feine Axial-Verzahnung
Allis, fine axial serrations

40mm

WIR EMPFEHLEN
WE RECOMMEND



Schaft sheath

&



Griff mit Sperre handle with ratchet

XPRESS LOCK®	260 mm	330 mm	450 mm
	13-1510XPI-26	13-1510XPI	13-1510XPI-45



Allis, feine Axial-Verzahnung
Allis, fine axial serrations

30mm

WIR EMPFEHLEN
WE RECOMMEND



Schaft sheath

&



Griff mit Sperre handle with ratchet

XPRESS LOCK®	260 mm	330 mm	450 mm
	13-1515XPI-26	13-1515XPI	13-1515XPI-45



TC Allis, Diamant-Zahnung
TC Allis, diamond serrations

43mm

WIR EMPFEHLEN
WE RECOMMEND



Schaft sheath

&



Griff mit Sperre handle with ratchet

XPRESS LOCK®	260 mm	330 mm	450 mm
	13-1530XPI-26	13-1530XPI	13-1530XPI-45

XPRESS LOCK[®] EINSÄTZE | INSERTS

GREIFZANGEN | GRASPING FORCEPS



TC Allis, Diamant-Zahnung
TC Allis, diamond serrations

35mm

WIR EMPFEHLEN
WE RECOMMEND



Schaft
sheath

&



Griff mit Sperre
handle **with ratchet**

XPRESS LOCK [®]	260 mm	330 mm	450 mm
	13-1535XPI-26	13-1535XPI	13-1535XPI-45



T-geformte Klemme
T-shape forceps

43mm

WIR EMPFEHLEN
WE RECOMMEND



Schaft
sheath

&



Griff mit Sperre
handle **with ratchet**

XPRESS LOCK [®]	260 mm	330 mm	450 mm
	13-1339XPI-26	13-1339XPI	13-1339XPI-45



T-geformte atraumatische Klemme, Hartmetall
T-shape atraumatic forceps, TC inserted jaws

43mm

WIR EMPFEHLEN
WE RECOMMEND



Schaft
sheath

&



Griff mit Sperre
handle **with ratchet**

XPRESS LOCK [®]	260 mm	330 mm	450 mm
	13-1328XPI-26	13-1328XPI	13-1328XPI-45



Hunter Greifer, gefenstert
Hunter grasper, fenestrated

22mm

WIR EMPFEHLEN
WE RECOMMEND



Schaft
sheath

&



Griff mit Sperre
handle **with ratchet**

XPRESS LOCK [®]	260 mm	330 mm	450 mm
	13-1571XPI-26	13-1571XPI	13-1571XPI-45

XPRESS LOCK® EINSÄTZE | INSERTS

GREIFZANGEN | GRASPING FORCEPS



De Bakey, atraumatische Zahnung
De Bakey, atraumatic serrations

40mm



**WIR EMPFEHLEN
WE RECOMMEND**



Schaft
sheath

&



Griff mit Sperre
handle with ratchet

XPRESS LOCK®	260 mm	330 mm	450 mm
	13-1520XPI-26	13-1520XPI	13-1520XPI-45



De Bakey, atraumatische Zahnung
De Bakey, atraumatic serrations

40mm



**WIR EMPFEHLEN
WE RECOMMEND**



Schaft
sheath

&



Griff mit Sperre
handle with ratchet

XPRESS LOCK®	260 mm	330 mm	450 mm
	13-1525XPI-26	13-1525XPI	13-1525XPI-45



Babcock atraumatische Greifzange, Hartmetall
Babcock atraumatic clamp, TC inserted jaws

40mm



**WIR EMPFEHLEN
WE RECOMMEND**



Schaft
sheath

&



Griff mit Sperre
handle with ratchet

XPRESS LOCK®	260 mm	330 mm	450 mm
	13-1331XPI-26	13-1331XPI	13-1331XPI-45



Babcock
Babcock

40mm



**WIR EMPFEHLEN
WE RECOMMEND**



Schaft
sheath

&



Griff mit Sperre
handle with ratchet

XPRESS LOCK®	260 mm	330 mm	450 mm
	13-1341XPI-26	13-1341XPI	13-1341XPI-45

XPRESS LOCK[®] EINSÄTZE | INSERTS

GREIFZANGEN | GRASPING FORCEPS

Babcock, gezahnt
Babcock, serrated

40mm

WIR EMPFEHLEN
WE RECOMMENDSchaft
sheath

&

Griff mit Sperre
*handle with ratchet*XPRESS LOCK[®]

260 mm

13-1540XPI-26

330 mm

13-1540XPI

450 mm

13-1540XPI-45

★ Babcock
Babcock

32mm

WIR EMPFEHLEN
WE RECOMMENDSchaft
sheath

&

Griff mit Sperre
*handle with ratchet*XPRESS LOCK[®]

260 mm

13-1541XPI-26

330 mm

13-1541XPI

450 mm

13-1541XPI-45

Babcock - De Bakey
Babcock - De Bakey

32mm

WIR EMPFEHLEN
WE RECOMMENDSchaft
sheath

&

Griff mit Sperre
*handle with ratchet*XPRESS LOCK[®]

260 mm

13-1542XPI-26

330 mm

13-1542XPI

450 mm

13-1542XPI-45

Babcock, kurze Ausführung, für delikate Anwendungen
Babcock, short version, for delicate applications

15mm

WIR EMPFEHLEN
WE RECOMMENDSchaft
sheath

&

Griff ohne Sperre
*handle w/o ratchet*XPRESS LOCK[®]

260 mm

13-1543XPI-26

330 mm

13-1543XPI

450 mm

13-1543XPI-45

XPRESS LOCK® EINSÄTZE | INSERTS

GREIFZANGEN | GRASPING FORCEPS



US Babcock, federnd, sehr flexibel und atraumatisch
US Babcock, with spring tension, flexible and atraumatic



**WIR EMPFEHLEN
WE RECOMMEND**



Schaft
sheath

&



Griff mit Sperre
handle with ratchet

XPRESS LOCK®	260 mm	330 mm	450 mm
	13-1544XPI-26	13-1544XPI	13-1544XPI-45



Babcock-De Bakey, atraumatische Zahnung
Babcock-De Bakey, atraumatic serrations



**WIR EMPFEHLEN
WE RECOMMEND**



Schaft
sheath

&



Griff mit Sperre
handle with ratchet

XPRESS LOCK®	260 mm	330 mm	450 mm
	13-1545XPI-26	13-1545XPI	13-1545XPI-45



Duval, mit Axial Zahnung
Duval, with axial serrations

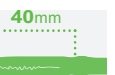

**WIR EMPFEHLEN
WE RECOMMEND**



Schaft
sheath

&



Griff mit Sperre
handle with ratchet

XPRESS LOCK®	260 mm	330 mm	450 mm
	13-1580XPI-26	13-1580XPI	13-1580XPI-45



TC Collin
TC Collin

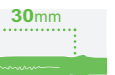

**WIR EMPFEHLEN
WE RECOMMEND**



Schaft
sheath

&







Griff mit Sperre
handle with ratchet

XPRESS LOCK®	260 mm	330 mm	450 mm
	13-1585XPI-26	13-1585XPI	13-1585XPI-45





XPRESS LOCK[®] EINSÄTZE | INSERTS

GREIFZANGEN | GRASPING FORCEPS

	<p>Greifzange, gezahnt <i>Strong graspers, serrated</i></p> <p style="text-align: right;">37mm</p>						
<p>WIR EMPFEHLEN <i>WE RECOMMEND</i></p> <p>5mm Schaft sheath & Griff mit Sperre handle <i>with ratchet</i></p>							
<p>XPRESS LOCK[®]</p> <table border="1"> <tr> <td>260 mm</td> <td>330 mm</td> <td>450 mm</td> </tr> <tr> <td>13-1332XPI-26</td> <td>13-1332XPI</td> <td>13-1332XPI-45</td> </tr> </table>	260 mm	330 mm	450 mm	13-1332XPI-26	13-1332XPI	13-1332XPI-45	
260 mm	330 mm	450 mm					
13-1332XPI-26	13-1332XPI	13-1332XPI-45					
	<p>★ Wellengreifer DG, atraum. wellenförmiger Verzahnung, doppelbewegl. <i>Wave grasper DG, atraumatic wavelike serrations, double action</i></p> <p style="text-align: right;">23mm</p>						
<p>WIR EMPFEHLEN <i>WE RECOMMEND</i></p> <p>5mm Schaft sheath & Griff mit Sperre handle <i>with ratchet</i></p>							
<p>XPRESS LOCK[®]</p> <table border="1"> <tr> <td>260 mm</td> <td>330 mm</td> <td>450 mm</td> </tr> <tr> <td>13-1375XPI-26</td> <td>13-1375XPI</td> <td>13-1375XPI-45</td> </tr> </table>	260 mm	330 mm	450 mm	13-1375XPI-26	13-1375XPI	13-1375XPI-45	
260 mm	330 mm	450 mm					
13-1375XPI-26	13-1375XPI	13-1375XPI-45					
	<p>Wellengreifer DG, atraum. wellenförmiger Verzahnung, einfachbewegl. <i>Wave grasper DG, atraumatic wavelike serrations, single action</i></p> <p style="text-align: right;">20mm</p>						
<p>WIR EMPFEHLEN <i>WE RECOMMEND</i></p> <p>5mm Schaft sheath & Griff mit Sperre handle <i>with ratchet</i></p>							
<p>XPRESS LOCK[®]</p> <table border="1"> <tr> <td>260 mm</td> <td>330 mm</td> <td>450 mm</td> </tr> <tr> <td>13-1381XPI-26</td> <td>13-1381XPI</td> <td>13-1381XPI-45</td> </tr> </table>	260 mm	330 mm	450 mm	13-1381XPI-26	13-1381XPI	13-1381XPI-45	
260 mm	330 mm	450 mm					
13-1381XPI-26	13-1381XPI	13-1381XPI-45					
	<p>Retraktionsgreifzange mit atraumatischer Innenverzahnung, einfachbewegl. <i>Retraction forceps with atraumatic inner teeth, single action</i></p> <p style="text-align: right;">15mm</p>						
<p>WIR EMPFEHLEN <i>WE RECOMMEND</i></p> <p>5mm Schaft sheath & Griff mit Sperre handle <i>with ratchet</i></p>							
<p>XPRESS LOCK[®]</p> <table border="1"> <tr> <td>260 mm</td> <td>330 mm</td> <td>450 mm</td> </tr> <tr> <td>13-1380XPI-26</td> <td>13-1380XPI</td> <td>13-1380XPI-45</td> </tr> </table>	260 mm	330 mm	450 mm	13-1380XPI-26	13-1380XPI	13-1380XPI-45	
260 mm	330 mm	450 mm					
13-1380XPI-26	13-1380XPI	13-1380XPI-45					

XPRESS LOCK® EINSÄTZE | INSERTS

GREIFZANGEN | GRASPING FORCEPS

	<p>★ Kobra Stil, gezahnter Greifer <i>Cobra style, serrated grasper</i></p> <p style="text-align: right;">14mm</p>				
	<p>WIR EMPFEHLEN <i>WE RECOMMEND</i></p> <p>5mm Schaft sheath & Griff mit Sperre handle with ratchet</p>				
	<table border="1"> <tr> <td>XPRESS LOCK®</td> <td>260 mm 13-1417XPI-26</td> <td>330 mm 13-1417XPI</td> <td>450 mm 13-1417XPI-45</td> </tr> </table>	XPRESS LOCK®	260 mm 13-1417XPI-26	330 mm 13-1417XPI	450 mm 13-1417XPI-45
XPRESS LOCK®	260 mm 13-1417XPI-26	330 mm 13-1417XPI	450 mm 13-1417XPI-45		
	<p>Wellengezahnter Greifer, spitze Ausführung, konisch <i>Wave grasper, pointed version, conical</i></p> <p style="text-align: right;">15mm</p>				
	<p>WIR EMPFEHLEN <i>WE RECOMMEND</i></p> <p>5mm Schaft sheath & Griff mit Sperre handle with ratchet</p>				
	<table border="1"> <tr> <td>XPRESS LOCK®</td> <td>260 mm 13-1546XPI-26</td> <td>330 mm 13-1546XPI</td> <td>450 mm 13-1546XPI-45</td> </tr> </table>	XPRESS LOCK®	260 mm 13-1546XPI-26	330 mm 13-1546XPI	450 mm 13-1546XPI-45
XPRESS LOCK®	260 mm 13-1546XPI-26	330 mm 13-1546XPI	450 mm 13-1546XPI-45		
	<p>Wellengezahnter Greifer, spitze Ausführung, flach <i>Wave grasper, pointed version, flat</i></p> <p style="text-align: right;">13mm</p>				
	<p>WIR EMPFEHLEN <i>WE RECOMMEND</i></p> <p>5mm Schaft sheath & Griff mit Sperre handle with ratchet</p>				
	<table border="1"> <tr> <td>XPRESS LOCK®</td> <td>260 mm 13-1547XPI-26</td> <td>330 mm 13-1547XPI</td> <td>450 mm 13-1547XPI-45</td> </tr> </table>	XPRESS LOCK®	260 mm 13-1547XPI-26	330 mm 13-1547XPI	450 mm 13-1547XPI-45
XPRESS LOCK®	260 mm 13-1547XPI-26	330 mm 13-1547XPI	450 mm 13-1547XPI-45		
	<p>Wellengezahnter Greifer, breite Ausführung <i>Wave grasper, wide version</i></p> <p style="text-align: right;">16mm</p>				
	<p>WIR EMPFEHLEN <i>WE RECOMMEND</i></p> <p>5mm Schaft sheath & Griff mit Sperre handle with ratchet</p>				
	<table border="1"> <tr> <td>XPRESS LOCK®</td> <td>260 mm 13-1548XPI-26</td> <td>330 mm 13-1548XPI</td> <td>450 mm 13-1548XPI-45</td> </tr> </table>	XPRESS LOCK®	260 mm 13-1548XPI-26	330 mm 13-1548XPI	450 mm 13-1548XPI-45
XPRESS LOCK®	260 mm 13-1548XPI-26	330 mm 13-1548XPI	450 mm 13-1548XPI-45		

XPRESS LOCK[®] EINSÄTZE | INSERTS

GREIFZANGEN | GRASPING FORCEPS



★ Krallengreifer, traumatische Maulteile
Claw forceps, traumatic jaws

35mm

WIR EMPFEHLEN
WE RECOMMEND

10mm

Schaft
sheath

&

Griff mit Sperre
handle with ratchetXPRESS LOCK[®]

260 mm

13-1605XPI-26

330 mm

13-1605XPI

450 mm

13-1605XPI-45



Krallengreifer, traumatische Maulteile
Claw forceps, traumatic jaws

25mm

WIR EMPFEHLEN
WE RECOMMEND

5mm

Schaft
sheath

&

Griff mit Sperre
handle with ratchetXPRESS LOCK[®]

260 mm

13-1606XPI-26

330 mm

13-1606XPI

450 mm

13-1606XPI-45



★ Tenaculum Greifzange, mit 1x1 scharfen Zähnen
Tenaculum forceps, with 1x1 sharp teeth

30mm

WIR EMPFEHLEN
WE RECOMMEND

10mm

Schaft
sheath

&

Griff mit Sperre
handle with ratchetXPRESS LOCK[®]

260 mm

13-1536XPI-26v

330 mm

13-1536XPI

450 mm

13-1536XPI-45



Tenaculum Greifzange, mit 1x1 scharfen Zähnen
Tenaculum forceps, with 1x1 sharp teeth

22mm

WIR EMPFEHLEN
WE RECOMMEND

5mm

Schaft
sheath

&

Griff mit Sperre
handle with ratchetXPRESS LOCK[®]

260 mm

13-1537XPI-26

330 mm

13-1537XPI

450 mm

13-1537XPI-45

XPRESS LOCK® EINSÄTZE | INSERTS

GREIFZANGEN | GRASPING FORCEPS



Mixer, mit Querzähnen
Mixer, cross serrated

20mm

WIR EMPFEHLEN
WE RECOMMEND



Schaft
sheath

&



Griff **ohne** Sperre
handle w/o ratchet

XPRESS LOCK®

260 mm

13-1333XPI-26

330 mm

13-1333XPI

450 mm

13-1333XPI-45



Mixer Klemmem, 45° gewinkelt
Mixer clamp, 45° angled

25mm

WIR EMPFEHLEN
WE RECOMMEND



Schaft
sheath

&



Griff **ohne** Sperre
handle w/o ratchet

XPRESS LOCK®

260 mm

13-1334XPI-26

330 mm

13-1334XPI

450 mm

13-1334XPI-45



Mixer Klemme, 90° gewinkelt
Mixer clamp, 90° angled

25mm

WIR EMPFEHLEN
WE RECOMMEND



Schaft
sheath

&



Griff **ohne** Sperre
handle w/o ratchet

XPRESS LOCK®

260 mm

13-1336XPI-26

330 mm

13-1336XPI

450 mm

13-1336XPI-45



Mixer Klemme, 90° gewinkelt
Mixer clamp, 90° angled

25mm

WIR EMPFEHLEN
WE RECOMMEND



Schaft
sheath

&



Griff **ohne** Sperre
handle w/o ratchet

XPRESS LOCK®

260 mm

13-1376XPI-26

330 mm

13-1376XPI

450 mm

13-1376XPI-45

XPRESS LOCK[®] EINSÄTZE | INSERTS

GREIFZANGEN | GRASPING FORCEPS



Glassmann, atraumatische Klemme
Glassmann, atraumatic clamp

40mm

WIR EMPFEHLEN
WE RECOMMEND

5mm

Schaft
sheath

&



Griff mit Sperre
handle with ratchet

XPRESS LOCK[®]

260 mm

13-1338XPI-26

330 mm

13-1338XPI

450 mm

13-1338XPI-45



Kocher, Axial Zahnung
Kocher, axial serrations

40mm

WIR EMPFEHLEN
WE RECOMMEND

10mm

Schaft
sheath

&



Griff mit Sperre
handle with ratchet

XPRESS LOCK[®]

260 mm

13-1550XPI-26

330 mm

13-1550XPI

450 mm

13-1550XPI-45

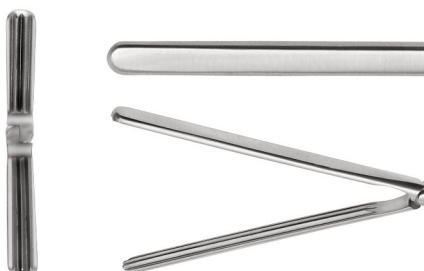

Kocher, Axial Zahnung
Kocher, axial serrations

60mm

WIR EMPFEHLEN
WE RECOMMEND

10mm

Schaft
sheath

&



Griff mit Sperre
handle with ratchet

XPRESS LOCK[®]

260 mm

13-1555XPI-26

330 mm

13-1555XPI

450 mm

13-1555XPI-45



De Bakey
De Bakey

40mm

WIR EMPFEHLEN
WE RECOMMEND

10mm

Schaft
sheath

&



Griff mit Sperre
handle with ratchet

XPRESS LOCK[®]

260 mm

13-1560XPI-26

330 mm

13-1560XPI

450 mm

13-1560XPI-45

XPRESS LOCK® EINSÄTZE | INSERTS

GREIFZANGEN & DISSEKTIONSZANGEN | GRASPING FORCEPS & DISSECTORS



Croce Olmi, 2-fach gefenestert, nach oben gebogen
Croce Olmi, double-fenestrated, curved upwards

29mm



WIR EMPFEHLEN
WE RECOMMEND



Schaft
sheath

&



Griff mit Sperre
handle **with** ratchet

XPRESS LOCK®

260 mm
13-1353XPI-26

330 mm
13-1353XPI

450 mm
13-1353XPI-45

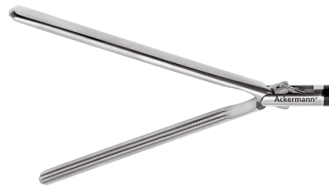

★
De Bakey
De Bakey

60mm



WIR EMPFEHLEN
WE RECOMMEND



Schaft
sheath

&



Griff mit Sperre
handle **with** ratchet

XPRESS LOCK®

260 mm
13-1565XPI-26

330 mm
13-1565XPI

450 mm
13-1565XPI-45



De Bakey
De Bakey

40mm



WIR EMPFEHLEN
WE RECOMMEND



Schaft
sheath

&



Griff mit Sperre
handle **with** ratchet

XPRESS LOCK®

260 mm
13-1570XPI-26

330 mm
13-1570XPI

450 mm
13-1570XPI-45



Stark gebog. Dissektionszange, gezahnt, für Trocar 10 mm
Strong curv. dissecting forceps, serrated, for Trocar 10 mm

20mm



WIR EMPFEHLEN
WE RECOMMEND



Schaft
sheath

&



Griff ohne Sperre
handle **w/o** ratchet

XPRESS LOCK®

260 mm
13-0530XPI-26

330 mm
13-0530XPI

450 mm
13-0530XPI-45

XPRESS LOCK[®] EINSÄTZE | *INSERTS*

DISSEKTIONSZANGEN | *DISSECTORS*



Leicht Gebog. Dissektionszange, gezahnt, für Trokar 10 mm
Soft curv. dissecting forceps, serrated, for Trocar 10 mm



**WIR EMPFEHLEN
WE RECOMMEND**



Schaft
sheath

&



Griff **ohne** Sperre
handle w/o ratchet

XPRESS LOCK[®]	260 mm	330 mm	450 mm
	13-1304XPI-26	13-1304XPI	13-1304XPI-45



Dissektionszange, gezahnt, stark gebogene Version
Dissector, serrated, strong curved version



**WIR EMPFEHLEN
WE RECOMMEND**



Schaft
sheath

&



Griff **ohne** Sperre
handle w/o ratchet

XPRESS LOCK[®]	260 mm	330 mm	450 mm
	13-1306XPI-26	13-1306XPI	13-1306XPI-45



Dissektionszange, gerade, fein gezahnt
Dissector, straight, delicate serrated



**WIR EMPFEHLEN
WE RECOMMEND**



Schaft
sheath

&



Griff **ohne** Sperre
handle w/o ratchet

XPRESS LOCK[®]	260 mm	330 mm	450 mm
	13-1307XPI-26	13-1307XPI	13-1307XPI-45



Dissektionszange, gebogen, fein gezahnt
Dissector, curved, delicate serrated



**WIR EMPFEHLEN
WE RECOMMEND**



Schaft
sheath

&



Griff **ohne** Sperre
handle w/o ratchet

XPRESS LOCK[®]	260 mm	330 mm	450 mm
	13-1308XPI-26	13-1308XPI	13-1308XPI-45

XPRESS LOCK® EINSÄTZE | INSERTS

DISSEKTIONSZANGEN | DISSECTORS



★ Maryland
Maryland

20mm

**WIR EMPFEHLEN
WE RECOMMEND**

5mm

Schaft
sheath

&



Griff **ohne** Sperre
handle **w/o** ratchet

XPRESS LOCK®

260 mm
13-1318XPI-26

330 mm
13-1318XPI

450 mm
13-1318XPI-45



Maryland
Maryland

15mm

**WIR EMPFEHLEN
WE RECOMMEND**

10mm

Schaft
sheath

&



Griff **ohne** Sperre
handle **w/o** ratchet

XPRESS LOCK®

260 mm
13-1340XPI-26

330 mm
13-1340XPI

450 mm
13-1340XPI-45



Schwach gebogene Maryland, stark eingesetzt
Soft-curved Maryland, offset

15mm

**WIR EMPFEHLEN
WE RECOMMEND**

5mm

Schaft
sheath

&



Griff **ohne** Sperre
handle **w/o** ratchet

XPRESS LOCK®

260 mm
13-1322XPI-26

330 mm
13-1322XPI

450 mm
13-1322XPI-45



Maryland, diamant-gezahnt
Maryland, diamond-serrated

25mm

**WIR EMPFEHLEN
WE RECOMMEND**

10mm

Schaft
sheath

&



Griff **ohne** Sperre
handle **w/o** ratchet

XPRESS LOCK®

260 mm
13-1411XPI-26

330 mm
13-1411XPI

450 mm
13-1411XPI-45

XPRESS LOCK[®] EINSÄTZE | *INSERTS*

DISSEKTIONSZANGEN | *DISSECTORS*



Maryland, diamant-gezahnt
Maryland, diamond-serrated

20mm

WIR EMPFEHLEN
WE RECOMMEND



Schaft
sheath

&



Griff **ohne** Sperre
handle w/o ratchet

XPRESS LOCK[®]	260 mm	330 mm	450 mm
	13-1412XPI-26	13-1412XPI	13-1412XPI-45



De Baakey/ Maryland, gebogen, atraumatisch
De Baakey/ Maryland, curved, atraumatic

35mm

WIR EMPFEHLEN
WE RECOMMEND



Schaft
sheath

&



Griff **ohne** Sperre
handle w/o ratchet

XPRESS LOCK[®]	260 mm	330 mm	450 mm
	13-1317XPI-26	13-1317XPI	13-1317XPI-45



Gefensterter Dissektor
Fenestrated dissector

16mm

WIR EMPFEHLEN
WE RECOMMEND



Schaft
sheath

&



Griff **ohne** Sperre
handle w/o ratchet

XPRESS LOCK[®]	260 mm	330 mm	450 mm
	13-1345XPI-26	13-1345XPI	13-1345XPI-45



Kelly Zange
Kelly forceps

15mm

WIR EMPFEHLEN
WE RECOMMEND



Schaft
sheath

&



Griff **ohne** Sperre
handle w/o ratchet

XPRESS LOCK[®]	260 mm	330 mm	450 mm
	13-1419XPI-26	13-1419XPI	13-1419XPI-45

XPRESS LOCK® EINSÄTZE | INSERTS

DISSEKTIONSZANGEN & SCHEREN | DISSECTORS & SCISSORS



Dissektionszange, kniegebogen, sehr fein
Dissecting forceps, right angled, very fine

17mm

**WIR EMPFEHLEN
WE RECOMMEND**



Schaft
sheath

&



Griff **ohne** Sperre
handle **w/o** ratchet

XPRESS LOCK®	260 mm	330 mm	450 mm
	13-1422XPI-26	13-1422XPI	13-1422XPI-45



Mikroschere, extrem feine Spitze, Schaft, gerade
Micro scissors, extremely delicate tip, shaft, straight

6mm

**WIR EMPFEHLEN
WE RECOMMEND**



Schaft
sheath

&



Griff **ohne** Sperre
handle **w/o** ratchet

XPRESS LOCK®	260 mm	330 mm	450 mm
	13-1344XPI-26	13-1344XPI	13-1344XPI-45



Mikroschere, extrem feine Spitze, Schaft, gebogen
Micro scissors, extremely delicate tip, shaft, curved

6mm

**WIR EMPFEHLEN
WE RECOMMEND**



Schaft
sheath

&



Griff **ohne** Sperre
handle **w/o** ratchet

XPRESS LOCK®	260 mm	330 mm	450 mm
	13-1346XPI-26	13-1346XPI	13-1346XPI-45

★
Hakenschere
Hook scissors



**WIR EMPFEHLEN
WE RECOMMEND**



Schaft
sheath

&



Griff **ohne** Sperre
handle **w/o** ratchet

XPRESS LOCK®	260 mm	330 mm	450 mm
	13-1431XPI-26	13-1431XPI	13-1431XPI-45

10mm

XPRESS LOCK[®] EINSÄTZE | INSERTS

SCHEREN | SCISSORS



Hakenschere, scharfe Schnittfläch
Hook scissors, sharp cutting edge

10mm

**WIR EMPFEHLEN
WE RECOMMEND**



Schaft sheath

&



Griff ohne Sperre
handle w/o ratchet

XPRESS LOCK [®]	260 mm	330 mm	450 mm
	13-1455XPI-26	13-1455XPI	13-1455XPI-45



★ Metzenbaum, gebogen, „Slim Line“
Metzenbaum, curved, „Slim Line“

17mm

**WIR EMPFEHLEN
WE RECOMMEND**



Schaft sheath

&



Griff ohne Sperre
handle w/o ratchet

	260 mm	330 mm	450 mm
XPRESS LOCK[®]	13-1309XPI-26	13-1309XPI	13-1309XPI-45
CERAMIX CUT[®]	13-1309CI-26	13-1309CI	13-1309CI-45



★ Metzenbaum, gerade
Metzenbaum, straight

20mm

**WIR EMPFEHLEN
WE RECOMMEND**



Schaft sheath

&



Griff ohne Sperre
handle w/o ratchet

	260 mm	330 mm	450 mm
XPRESS LOCK[®]	13-1460XPI-26	13-1460XPI	13-1460XPI-45
CERAMIX CUT[®]	13-1460CI-26	13-1460CI	13-1460CI-45



★ Metzenbaum, gebogen
Metzenbaum, curved

18mm

**WIR EMPFEHLEN
WE RECOMMEND**



Schaft sheath

&



Griff ohne Sperre
handle w/o ratchet

	260 mm	330 mm	450 mm
XPRESS LOCK[®]	13-1461XPI-26	13-1461XPI	13-1461XPI-45
CERAMIX CUT[®]	13-1461CI-26	13-1461CI	13-1461CI-45

XPRESS LOCK® EINSÄTZE | INSERTS

SCHEREN | SCISSORS



Metzenbaum, gerade, gezahnt
Metzenbaum, straight, serrated

20mm



WIR EMPFEHLEN
WE RECOMMEND



Schaft
sheath

&



Griff **ohne Sperre**
handle **w/o ratchet**

	260 mm	330 mm	450 mm
XPRESS LOCK®	13-1465XPI-26	13-1465XPI	13-1465XPI-45
CERAMIX CUT®	13-1465CI-26	13-1465CI	13-1465CI-45



Metzenbaum, gebogen, gezahnt
Metzenbaum, curved, serrated

16mm



WIR EMPFEHLEN
WE RECOMMEND



Schaft
sheath

&



Griff **ohne Sperre**
handle **w/o ratchet**

	260 mm	330 mm	450 mm
XPRESS LOCK®	13-1466XPI-26	13-1466XPI	13-1466XPI-45
CERAMIX CUT®	13-1466CI-26	13-1466CI	13-1466CI-45



Metzenbaum, gebogen, mittlere Blattlänge
Metzenbaum, curved, medium blades

17mm



WIR EMPFEHLEN
WE RECOMMEND



Schaft
sheath

&



Griff **ohne Sperre**
handle **w/o ratchet**

	260 mm	330 mm	450 mm
XPRESS LOCK®	13-1467XPI-26	13-1467XPI	13-1467XPI-45
CERAMIX CUT®	13-1467CI-26	13-1467CI	13-1467CI-45



Miniatur Metzenbaum, gebogen, auf 4 mm verjüngt
Miniature Metzenbaum, curved, tapered down to 4 mm

12mm



WIR EMPFEHLEN
WE RECOMMEND



Schaft
sheath

&



Griff **ohne Sperre**
handle **w/o ratchet**

	260 mm	330 mm	450 mm
XPRESS LOCK®	13-1468XPI-26	13-1468XPI	13-1468XPI-45
CERAMIX CUT®	13-1468CI-26	13-1468CI	13-1468CI-45

XPRESS LOCK[®] EINSÄTZE | INSERTS

SCHEREN & NADELHALTER | SCISSORS & NEEDLEHOLDERS



Metzenbaum, gerade, einfachbeweglich
Metzenbaum, straight, single action



**WIR EMPFEHLEN
WE RECOMMEND**



Schaft sheath

&



Griff ohne Sperre
handle w/o ratchet

XPRESS LOCK [®]	260 mm	330 mm	450 mm
	13-1655XPI-26	13-1655XPI	13-1655XPI-45



Peritoneal Schere, stumpfe Spitze
Peritoneal scissors, blunt tips



**WIR EMPFEHLEN
WE RECOMMEND**



Schaft sheath

&



Griff ohne Sperre
handle w/o ratchet

	260 mm	330 mm	450 mm
XPRESS LOCK [®]	13-1650XPI-26	13-1650XPI	13-1650XPI-45
CERAMIX CUT [®]	13-1650CI-26	13-1650CI	13-1650CI-45



Nadelhalter, mit Querzähnen
Needleholder, cross serrated



**WIR EMPFEHLEN
WE RECOMMEND**



Schaft sheath

&



Griff mit Sperre
handle with ratchet

	260 mm	330 mm	450 mm
XPRESS LOCK [®]	13-1347XPI-26	13-1347XPI	13-1347XPI-45



Nadelhalter, mit Querzähnen
Needleholder, cross serrated



**WIR EMPFEHLEN
WE RECOMMEND**



Schaft sheath

&



Griff mit Sperre
handle with ratchet

	260 mm	330 mm	450 mm
XPRESS LOCK [®]	13-1348XPI-26	13-1348XPI	13-1348XPI-45

XPRESS LOCK® EINSÄTZE | INSERTS

NADELHALTER | NEEDLEHOLDERS



Nadelhalter, Hartmetall
Needleholder, TC inserts

10mm

**WIR EMPFEHLEN
WE RECOMMEND**



Schaft
sheath

&



Griff mit Sperre
handle with ratchet

XPRESS LOCK®

260 mm
13-1349XPI-26

330 mm
13-1349XPI

450 mm
13-1349XPI-45



Nadelhalter, Hartmetall, spitze Ausführung
Needleholder, TC inserts, pointed version

10mm

**WIR EMPFEHLEN
WE RECOMMEND**



Schaft
sheath

&



Griff mit Sperre
handle with ratchet

XPRESS LOCK®

260 mm
13-1351XPI-26

330 mm
13-1351XPI

450 mm
13-1351XPI-45



Nadelhalter, spitze Ausführung
Needleholder, pointed version

10mm

**WIR EMPFEHLEN
WE RECOMMEND**



Schaft
sheath

&



Griff mit Sperre
handle with ratchet

XPRESS LOCK®

260 mm
13-1590XPI-26

330 mm
13-1590XPI

450 mm
13-1590XPI-45



Nadelhalter, spitze Ausführung
Needleholder, pointed version

8mm

**WIR EMPFEHLEN
WE RECOMMEND**



Schaft
sheath

&



Griff mit Sperre
handle with ratchet

XPRESS LOCK®

260 mm
13-1595XPI-26

330 mm
13-1595XPI

450 mm
13-1595XPI-45

XPRESS LOCK[®] EINSÄTZE | *INSERTS*

BIOPSIESTANZEN & BIOPSELÖFFEL | *BIOPSY PUNCHES & BIOPSY SPOONS*



Biopsie Hakenstanze, ohne Dorn
Biopsy hook punch, without spike

11mm

WIR EMPFEHLEN
WE RECOMMEND



Schaft
sheath

&



Griff ohne Sperre
handle w/o ratchet

XPRESS LOCK[®]

260 mm

13-1470XPI-26

330 mm

13-1470XPI

450 mm

13-1470XPI-45



Biopsie Hakenstanze, mit Dorn
Biopsy hook punch, with spike

11mm

WIR EMPFEHLEN
WE RECOMMEND



Schaft
sheath

&



Griff ohne Sperre
handle w/o ratchet

XPRESS LOCK[®]

260 mm

13-1475XPI-26

330 mm

13-1475

450 mm

13-1475XPI-45



Biopsie Hakenstanze
Biopsy hook punch

12mm

WIR EMPFEHLEN
WE RECOMMEND



Schaft
sheath

&



Griff ohne Sperre
handle w/o ratchet

XPRESS LOCK[®]

260 mm

13-1480XPI-26

330 mm

13-1480XPI

450 mm

13-1480XPI-45



Biopsielöffel, einfachbeweglich
Biopsy spoon, single action

10mm

WIR EMPFEHLEN
WE RECOMMEND



Schaft
sheath

&



Griff ohne Sperre
handle w/o ratchet

XPRESS LOCK[®]

260 mm

11-1645XPI-26

330 mm

11-1645XPI

450 mm

11-1645XPI-45

XPRESS LOCK® EINSÄTZE | INSERTS

BIOPSIELÖFFEL | *BIOPSY SPOONS*



Biopsielöffel, ohne Dorn
Biopsy spoon, without spike



**WIR EMPFEHLEN
WE RECOMMEND**



Schaft
sheath

&



Griff **ohne** Sperre
handle w/o ratchet

XPRESS LOCK®	260 mm	330 mm	450 mm
	13-1485XPI-26	13-1485XPI	13-1485XPI-45



★ Biopsielöffel, mit Dorn
Biopsy spoon, with spike

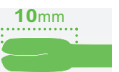

**WIR EMPFEHLEN
WE RECOMMEND**



Schaft
sheath

&



Griff **ohne** Sperre
handle w/o ratchet

XPRESS LOCK®	260 mm	330 mm	450 mm
	13-1490XPI-26	13-1490XPI	13-1490XPI-45



★ Große Löffelzange
Big spoon forceps

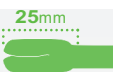

**WIR EMPFEHLEN
WE RECOMMEND**



Schaft
sheath

&



Griff **ohne** Sperre
handle w/o ratchet

XPRESS LOCK®	260 mm	330 mm	450 mm
	13-1660XPI-26	13-1660XPI	13-1660XPI-45



Blakesley Präparationzange, gefenestert
Blakesley dissecting and biopsy forceps, fenestrated



**WIR EMPFEHLEN
WE RECOMMEND**



Schaft
sheath

&



Griff **ohne** Sperre
handle w/o ratchet

XPRESS LOCK®	260 mm	330 mm	450 mm
	13-1388XPI-26	13-1388XPI	13-1388XPI-45



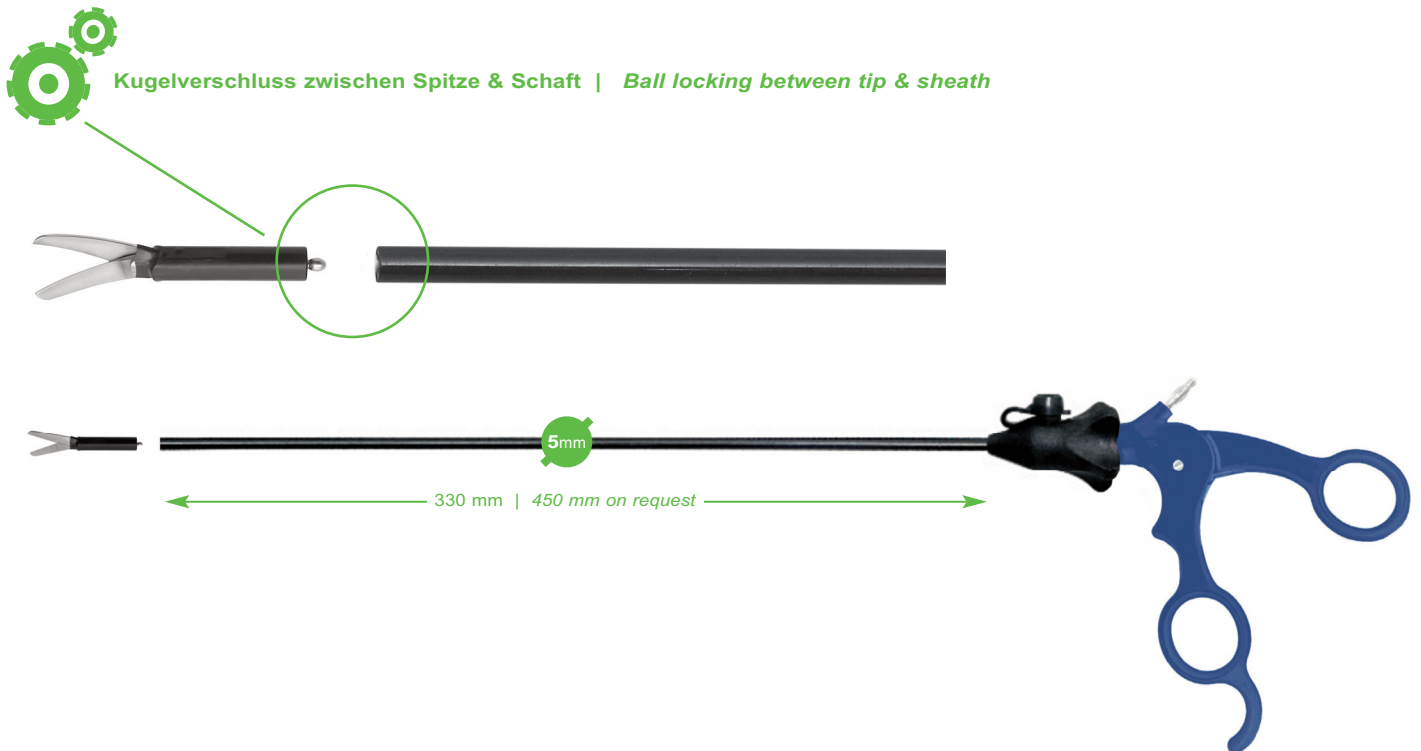



TI LINE ©

FAKTEN & VORTEILE | *FACTS & FEATURES*



- ▶ Zerlegbar in Tip und Schaft-Griff Einheit
- ▶ Neue einmalverwendbare Instrumentenspitze bei jeder Anwendung
- ▶ Wiederverwendbarer Schaft-Griff Einheit
- ▶ Keine Lücken zwischen wiederverwendbarem und einmalverwendbarem Instrumententeil
- ▶ Hochqualitative, ergonomische Griffe mit Spülkanal und HF-Anschluss
- ▶ Schnelle, einfache und sichere Montage mit Kugel-Verriegelung
- ▶ Vollständig in Deutschland hergestellt
- ▶ Kaum Reparatur oder Wartung notwendig
- ▶ Neues Konzept vereint Vorteile von einmal- und wiederverwendbaren Instrumenten
- ▶ Länge von 330 mm, weitere Längen auf Anfrage
- ▶ *Demountable into tip and sheath-handle combination*
- ▶ *New disposable tip for each procedure*
- ▶ *Reusable sheath-handle combination*
- ▶ *No gaps between reusable and disposable part*
- ▶ *High-quality, ergonomic handle with flushing channel and HF-port*
- ▶ *Quick, easy and safe assembly with the ball and socket coupling*
- ▶ *Fully made in Germany*
- ▶ *Nearly no need for repair or maintance*
- ▶ *New concept combines the benefits of single-use and reusable instruments*
- ▶ *Length of 330 mm, other lengths on request*

TI LINE ©

EINWEG-INSTRUMENTENSPIZEN | DISPOSABLE TIPS

	13-1468TI-EC	Miniatur Metzenbaum <i>Miniature Metzenbaum</i>	VE 10 Stk UOM 10 pcs
	13-1469TI-EC	Metzenbaum Schere, gebogen <i>Metzenbaum scissors, curved</i>	VE 10 Stk UOM 10 pcs
	13-1301TI-EC	Gefesterte Greifzange, flache Maulteile <i>Fenestrated grasping forceps, flat jaws</i>	VE 10 Stk UOM 10 pcs
	13-1318TI-EC	Maryland Greifzange <i>Maryland grasping forceps</i>	VE 10 Stk UOM 10 pcs
	13-1323TI-EC	Endo Clinch <i>Endo clinch</i>	VE 10 Stk UOM 10 pcs
	13-1343TI-EC	Gefensterte Klemme <i>Fenestrated clamp</i>	VE 10 Stk UOM 10 pcs

GRIFFE | HANDLES

	13-13583TI-EC	Ohne Sperre <i>Non-ratchet</i>	TI Line© Polyamid-Handgriff - ergonomisch TI Line© polyamide handle - ergonomic
	13-1384TI-EC	universelle Sperre <i>universal ratchet</i>	

FUTURE LAP®

FAKTEN & VORTEILE | FACTS & FEATURES

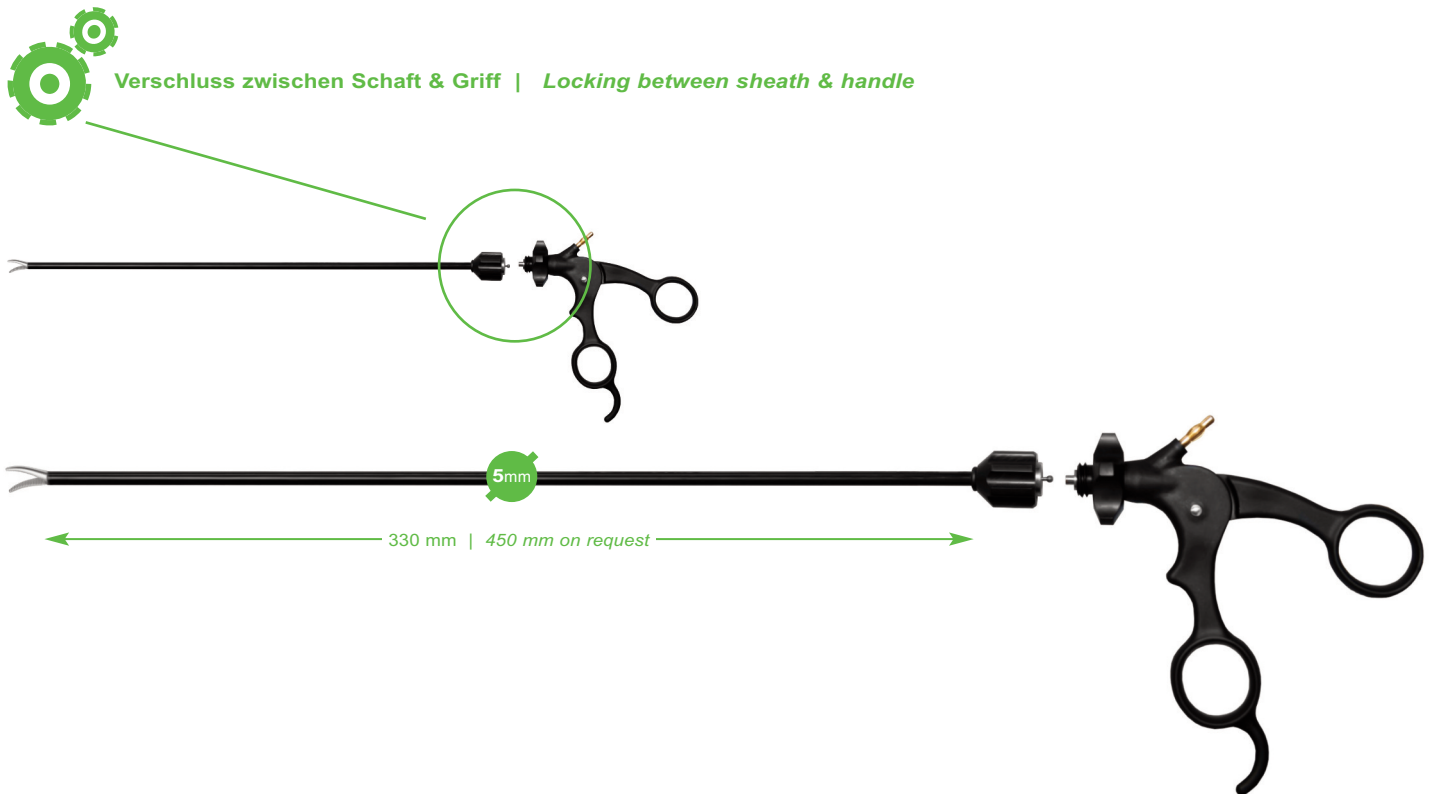

- ▶ Zerlegbar in Tip-Schaft Einheit und Griff
- ▶ Neuer einmalverwendbarer Instrumenteneinsatz bei jeder Anwendung
- ▶ Wiederverwendbarer Griff
- ▶ Keine Lücken zwischen wiederverwendbarem und einmalverwendbarem Instrumententeil
- ▶ Hochqualitative, ergonomische Griffe mit Spülkanal und HF-Anschluss
- ▶ Schnelle, einfache und sichere Montage mit Kugel-Verriegelung
- ▶ Vollständig in Deutschland hergestellt
- ▶ Kaum Reparatur oder Wartung notwendig
- ▶ Neues Konzept vereint Vorteile von einmal- und wiederverwendbaren Instrumenten
- ▶ Länge von 330 mm, weitere Längen auf Anfrage
- ▶ *Demountable into tip-sheath-combination and handle*
- ▶ *New disposable insert for each procedure*
- ▶ *Reusable handle*
- ▶ *No gaps between reusable and disposable part*
- ▶ *High-quality, ergonomic handle with flushing channel and HF-port*
- ▶ *Quick, easy and safe assembly with the ball and socket coupling*
- ▶ *Fully made in Germany*
- ▶ *Nearly no need for repair or maintenance*
- ▶ *New concept combines the benefits of single-use and reusable instruments*
- ▶ *Length of 330 mm, other lengths on request*

FUTURE LAP ©

EINWEG-MAULTEIL-SCHAFT-KOMBINATION | DISPOSABLE TIP-SHEATH-ASSEMBLY **13-1466DDI**Metzenbaum Schere, gebogen, gezahnt
*Metzenbaum scissors, curved, serrated*VE 10 Stk
UOM 10 pcs**13-1467DDI**Metzenbaum Schere, gebogen, mittlere Blattlänge
*Metzenbaum scissors, curved, medium blades*VE 10 Stk
UOM 10 pcs**13-1301DDI**Gefesterte Greifzange, flache Maulteile
*Fenestrated grasping forceps, flat jaws*VE 10 Stk
UOM 10 pcs**13-1318DDI**Maryland Greifzange
*Maryland grasping forceps*VE 10 Stk
UOM 10 pcs**13-1323DDI**Endo Clinch
*Endo clinch*VE 10 Stk
UOM 10 pcs

FUTURE LAP®

ENDO LOCK® GRIFFE FÜR FUTURE LAP® | ENDO LOCK® HANDLES FOR FUTURE LAP®

► Future Lap® Maulteil-Schaft-Kombinationen sind kompatibel mit allen Endo Lock® Griffen

► Future Lap® tip-sheath-parts are compatible with all Endo Lock® handles



13-1367RCFI

Ohne Sperre
Non-ratchet

13-1368RCFI

traditionelle Sperre
traditional ratchet

13-1369FRI

französische Sperre
french ratchet

13-1384RCFI

universelle Sperre
universal ratchet

Endo Lock® Kohlefaserhandgriff - **ergonomisch**
Endo Lock® carbon fiber handle - **ergonomic**

Endo Lock® Kohlefaserhandgriff - **standard**
Endo Lock® carbon fiber handle - **standard**

FUTURE LAP ©

SYSTEM CS © GRIFFE FÜR FUTURE LAP © | SYSTEM CS © HANDLES FOR FUTURE LAP ©

► Future Lap © Maulteil-Schaft-Kombinationen sind kompatibel mit allen System CS © Griffen

► Future Lap © tip-sheath-parts are compatible with all System CS © handles



13-1367CS	Ohne Sperre <i>Non-ratchet</i>	System CS © Polyamid-Handgriff - ergonomisch System CS © polyamide handle - ergonomic
13-1368CS	traditionelle Sperre <i>traditional ratchet</i>	
13-1384CS	universelle Sperre <i>universal ratchet</i>	
13-1369CS	französische Sperre <i>french ratchet</i>	

EINWEGINSTRUMENTE | *SINGLE-USE INSTRUMENTS*

FAKTEN & VORTEILE | *FACTS & FEATURES*

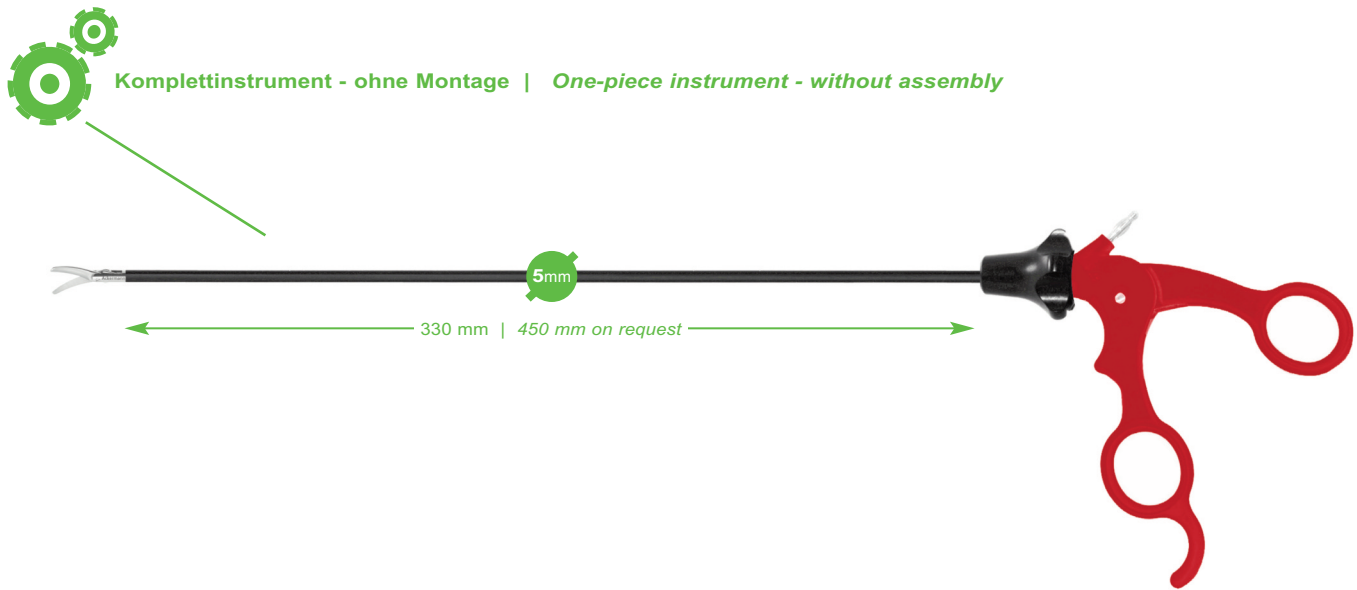

- ▶ *Komplett einmalverwendbares, steril verpacktes Instrument*
- ▶ *In einem Stück gefertigt, nicht demontierbar*
- ▶ *Keine Kosten für Sterilisation oder Risiken - damit weniger zeitaufwendig*
- ▶ *Kein Montagevorwissen nötig*
- ▶ *Komplett in Deutschland gefertigt*
- ▶ *Hochqualitative, ergonomische Griffe mit HF-Anschluss*
- ▶ *Wartung und Reparatur entfallen*
- ▶ *Farbkodiertes Griff-Design*
- ▶ *Länge von 330 mm, weitere Längen auf Anfrage*
- ▶ *Weitere Maulteiltypen auf Anfrage möglich*
- ▶ *Instrument mit Sperre auf Anfrage möglich*
- ▶ *Fully disposable, sterile packed instrument*
- ▶ *One-piece design, non-demountable*
- ▶ *No sterilization costs or risks - due to this less time-consuming*
- ▶ *No assembly issues*
- ▶ *Fully made in Germany*
- ▶ *High-quality, ergonomic handle with HF-port*
- ▶ *Maintenance or repair not needed*
- ▶ *Colour-coded handle design*
- ▶ *Length of 330 mm, other lengths on request*
- ▶ *More jaw patterns on request*
- ▶ *Instrument with ratchet on request*

EINWEGINSTRUMENTE | *SINGLE-USE INSTRUMENTS*

EINWEG-KOMPLETTINSTRUMENTE | *COMPLETE DISPOSABLE INSTRUMENTS*

		13-1466DDRH	Metzenbaum, gezahnt, gebogen, HF-Port <i>Metzenbaum, serrated, curved, HF-port</i>	VE 6 Stk UOM 6 pcs
		13-1467DDRH	Metzenbaum, gebogen, HF-Port <i>Metzenbaum, curved, HF-port</i>	VE 6 Stk UOM 6 pcs
		13-1318DDRH	Maryland, quer gezahnt, HF-Port <i>Maryland, cross-serrated, HF-port</i>	VE 6 Stk UOM 6 pcs
		13-1323DDRH	Endo Clinch, HF-Port <i>Endo clinch, HF-port</i>	VE 6 Stk UOM 6 pcs
		13-1323DDRHR	Endo Clinch mit Sperre, HF-Port <i>Endo clinch with ratchet, HF-port</i>	VE 6 Stk UOM 6 pcs

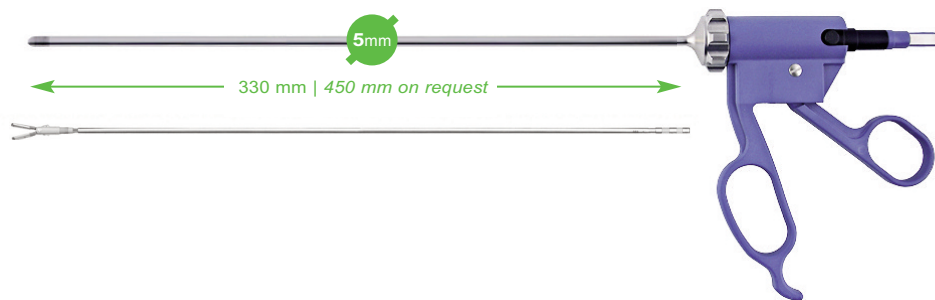
BIPOLARE INSTRUMENTE | *BIPOLAR INSTRUMENTS*PREMIUM LINIE | *PREMIUM LINE* ★**13-1700SI**Handgriff
Handle**13-1700R**Schaft
Sheath**13-1701I**Maryland, Einsatz
Maryland, insert**13-1702I**Gefensterter Greifer, Einsatz
Fenestrated grasper, insert**13-1703I**Schere, Einsatz
Scissors, insert**13-1704I**Mikro Greifer, Einsatz
Micro forceps, insert**13-1705I**Delta Greifer, Einsatz
Delta grasper, insert**13-1706I**Greifzange, gebogen, gefenstert, Einsatz
Grasping forceps, curved, fenestrated, insert

BIPOLARE INSTRUMENTE | BIPOLAR INSTRUMENTS

STANDARD LINIE | STANDARD LINE

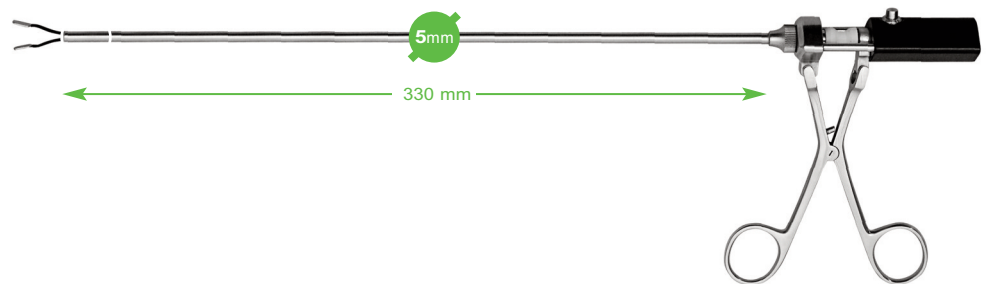

13-1646SI

Handgriff für modulare bipolare Zangen
Handle for modular bipolar forceps

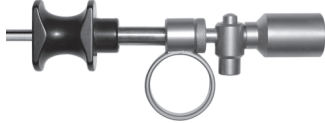

13-1647SI

Schieber-Handgriff für modulare bipolare Zangen
Slide handle for modular bipolar forceps



13-1630IWO

Fasszange, gefenstert inkl. Schaft
Forceps, fenestrated incl. sheath



13-1633IWO

Schere inkl. Schaft
Scissors incl. sheath



13-1634IWO

Fasszange, breites Maul, kurze Version inkl. Schaft
Forceps, wide jaws, short version incl. sheath



13-1635IWO

Fasszange, breites Maul inkl. Schaft
Forceps, wide jaws incl. sheath



13-1640IWO

Fasszange, Mikro-Spitze inkl. Schaft
Forceps, micro tip incl. sheath



13-1642IWO

Fasszange, ohne Nase inkl. Schaft
Forceps, without nose incl. sheath



13-1645IWO

Maryland inkl. Schaft
Maryland incl. sheath

BIPOLARE INSTRUMENTE | *BIPOLAR INSTRUMENTS*

SYSTEM A[®]

ECONOMY LINIE | *ECONOMY LINE*

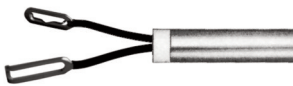
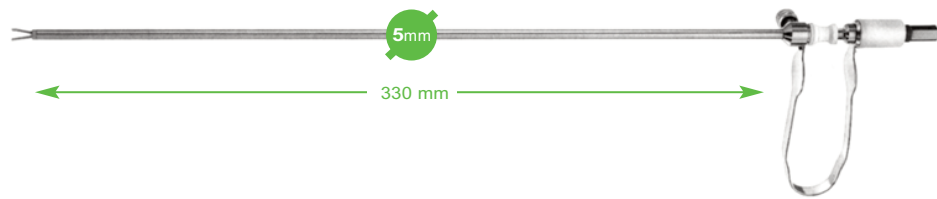
**13-1630A**

Koagulationszange mit leichter Verzahnung, nicht zerlegbar
Coagulation forceps with slight serration, non-demountable

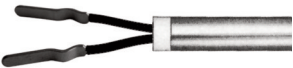
**13-1635A**

Koagulationszange, nicht zerlegbar
Coagulation forceps, non-demountable

**13-1640A**

Fasszange, nicht zerlegbar
Forceps, non-demountable

**13-1642A**

Koagulationszange ohne Nase, nicht zerlegbar
Coagulation forceps without nose, non-demountable

SYSTEM ADG © & SYSTEM DG © ★

SYSTEM ADG © & SYSTEM DG ©



- ▶ Für exzellente Gewebefixation
 - ▶ Atraumatische Wellen- oder Retraktionsmaulteile
 - ▶ Komplettinstrument mit Schieberhandgriff
 - ▶ Rotierbares Instrument mit Spülkanal (System ADG ©)
 - ▶ 5 mm Schaft Durchmesser
 - ▶ Erhältlich mit 360 mm oder 450 mm Arbeitslänge
- ▶ For excellent tissue grasping control
 - ▶ Atraumatic wave or retraction jaws in single or double action
 - ▶ One-piece instrument with slide lock ratchet
 - ▶ Rotatable instrument with cleaning port (System ADG ©)
 - ▶ 5 mm sheath diameter
 - ▶ With 360 mm or 450 mm working length available

SYSTEM ADG ©



13-1375ADG	360 mm	Wellengreifer, Schieberhandgriff, spülbar, drehbar, doppelbeweglich
13-1375ADG-45	450 mm	Wave grasper, slide ratchet handle, flushable, rotatable, double action
13-1380ADG	360 mm	Retraktionszange, Schieberhandgriff, spülbar, drehbar, atraumatische Innenverzahnung, einfachbeweglich
13-1380ADG-45	450 mm	Retraction forceps, slide ratchet handle, flushable, rotatable, atraumatic inner serration, single action
13-1381ADG	360 mm	Wellengreifer, Schieberhandgriff, spülbar, drehbar, einfachbeweglich
13-1381ADG-45	450 mm	Wave grasper, slide ratchet handle, flushable, rotatable, single action

SYSTEM ADG® & SYSTEM DG® ★

SYSTEM DG®

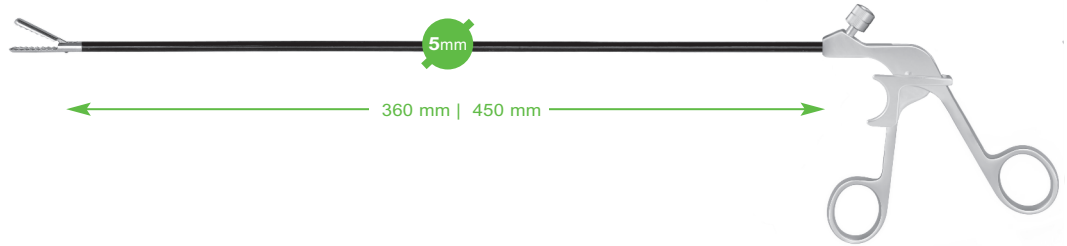

13-1375DG	360 mm	Wellengreifer, Schieberhandgriff, spülbar, doppelbeweglich <i>Wave grasper, slide ratchet handle, flushable, double action</i>
13-1375DG-45	450 mm	
13-1380DG	360 mm	Retraktionszange, Schieberhandgriff, spülbar, atraumatische Innenverzahnung, einfachbeweglich <i>Retraction forceps, slide ratchet handle, flushable, atraumatic inner serration, single action</i>
13-1380DG-45	450 mm	
13-1381DG	360 mm	Wellengreifer, Schieberhandgriff, spülbar, einfachbeweglich <i>Wave grasper, slide ratchet handle, flushable, single action</i>
13-1381DG-45	450 mm	

ANVIL GREIFER | *ANVIL GRASPER*

ANVIL GREIFER | *ANVIL GRASPER*



13-1599A	Anvil Greifer, verstärkte Ausführung, doppelbeweglich <i>Anvil grasper, reinforced version, double action</i>	
-----------------	--	--

NADELHALTER | NEEDLEHOLDERS ★

PISTOLENGRIFF NADELHALTER | PISTOL GRIP NEEDLEHOLDERS

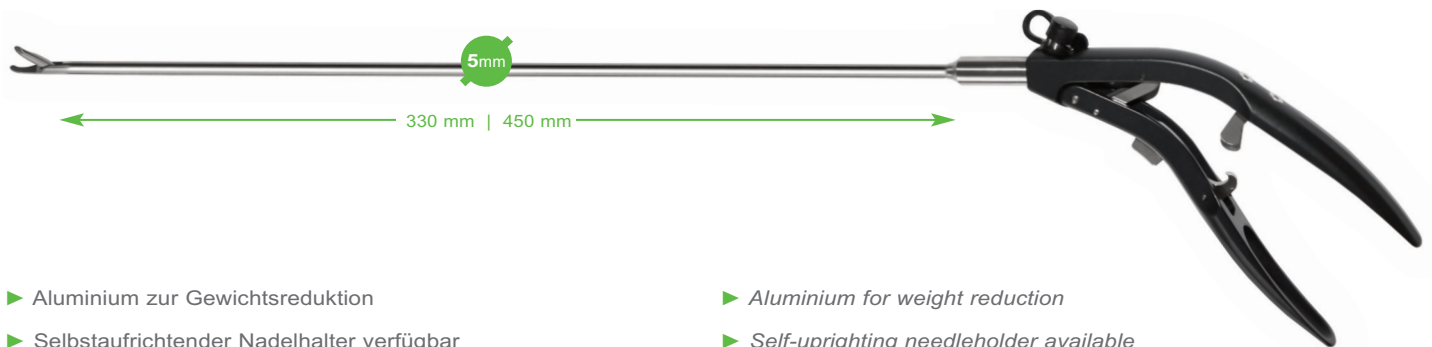

- ▶ Aluminium zur Gewichtsreduktion
- ▶ Selbstaufrichtender Nadelhalter verfügbar
- ▶ Ergonomischer Pistolenhandgriff
- ▶ Justierbare Sperre
- ▶ Instrumentenspülkanal
- ▶ 5 mm Schaft Durchmesser
- ▶ Erhältlich mit 330 mm oder 450 mm Arbeitslänge
- ▶ Bruchsicherer, rostfreier Stahl
- ▶ Überladungsschutz

- ▶ Aluminium for weight reduction
- ▶ Self-uprighting needleholder available
- ▶ Ergonomic pistol grip handle
- ▶ Adjustable ratchet
- ▶ Instrument cleaning port
- ▶ 5 mm sheath diameter
- ▶ With 330 mm or 450 mm working length available
- ▶ Break-proof stainless steel
- ▶ Overload protection

	13-1591P	330 mm	Pistolengriff Nadelhalter, bruchsicher, spülbar, kurz, gerade <i>Pistol Grip Needleholder, break proof, flushable, short, straight</i>
	13-1591P-45	450 mm	
	13-1593P	330 mm	Pistolengriff, bruchsicher, spülbar, rechtsgebogen <i>Pistol Grip Needleholder, break proof, flushable, right curved</i>
	13-1593P-45	450 mm	
	13-1594P	330 mm	Pistolengriff Nadelhalter, bruchsicher, spülbar, linksgebogen <i>Pistol Grip Needleholder, break proof, flushable, left curved</i>
	13-1594P-45	450 mm	
	13-1590PSFU	330 mm	Pistolengriff Romeo Nadelhalter, bruchsicher, spülbar, selbstaufrichtend <i>Pistol Grip Romeo Needleholder, break proof, flushable, self-uprighting</i>
	13-1590PSFU-45	450 mm	

NADELHALTER | *NEEDLEHOLDERS*

ETH NADELHALTER | *ETH NEEDLEHOLDERS*

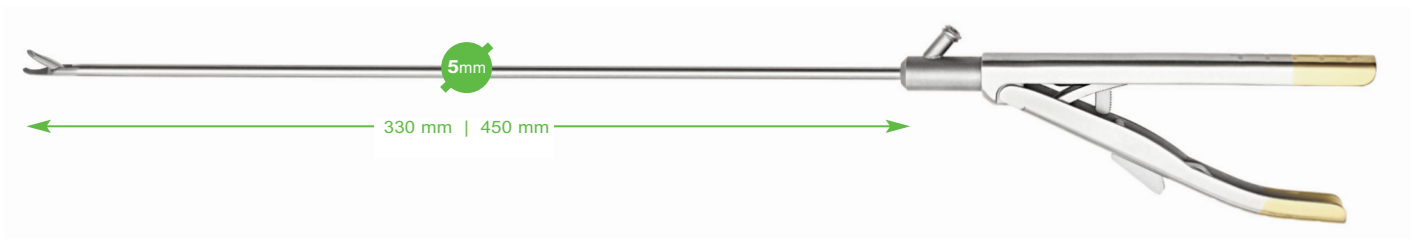

- ▶ Selbstaufrichtender Nadelhalter verfügbar
 - ▶ Ergonomischer Axialgriff
 - ▶ Integrierte Universalsperre
 - ▶ Instrumentenspülkanal
 - ▶ 5 mm Schaft Durchmesser
 - ▶ Erhältlich mit 330 mm oder 450 mm Arbeitslänge
 - ▶ Bruchsicherer, rostfreier Stahl
 - ▶ Überladungsschutz
- ▶ *Self-uprighting needleholder available*
 - ▶ *Ergonomic axial handle*
 - ▶ *Integrated universal ratchet*
 - ▶ *Instrument cleaning port*
 - ▶ *5 mm sheath diameter*
 - ▶ *With 330 mm or 450 mm working length available*
 - ▶ *Break-proof stainless steel*
 - ▶ *Overload protection*

**13-1591ET**

330 mm

ETH-Nadelhalter, bruchsicher, Axialgriff, spülbar, kurz, gerade
*ETH-Needleholder, break proof, axial handle, flushable, short, straight***13-1591ET-45**

450 mm

**13-1593ET**

330 mm

ETH-Nadelhalter, bruchsicher, Axialgriff, spülbar, rechtsgebogen
*ETH-Needleholder, break proof, axial handle, flushable, right curved***13-1593ET-45**

450 mm

**13-1594ET**

330 mm

ETH-Nadelhalter, bruchsicher, Axialgriff, spülbar, linksgebogen
*ETH-Needleholder, break proof, axial handle, flushable, left curved***13-1594ET-45**

450 mm

**13-1590ETSFU**

330 mm

ETH-Romeo-Nadelhalter, bruchsicher, Axialgriff, spülbar, selbstaufrichtend

13-1590ETSFU-45

450 mm

ETH-Romeo-Needleholder, break proof, axial handle, flushable, self-uprighting

FASCIA INSTRUMENTE | FASCIA CLOSING DEVICES ★

FASCIA NAHTINSTRUMENT | FASCIA CLOSING SUTURE PASSER

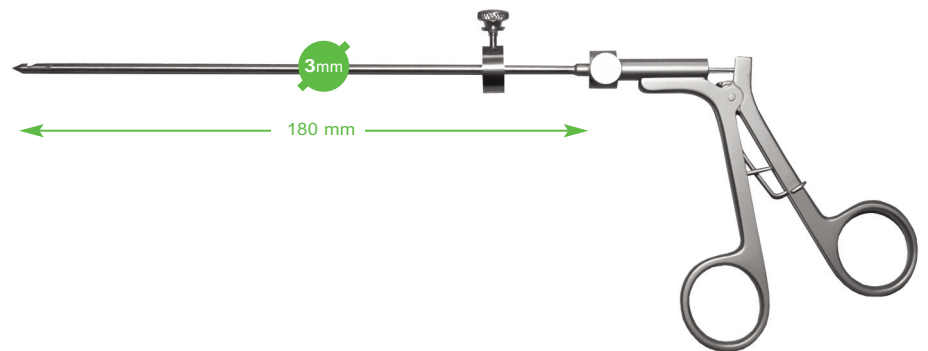

	10-1114	180 mm	Ø 3 mm	Fascia Nahtinstrument mit Anschlag Fascia Closing Suture Passer with Stop
---	----------------	--------	--------	--

FASCIA NAHTKANÜLE | FASCIA CLOSING CANNULA

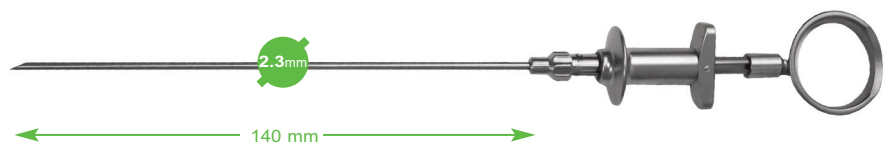

	10-1113	140 mm	Ø 2.3 mm	Fascia Nahtkanüle Fascia Closing Cannula
---	----------------	--------	----------	---

FLEXIBLE RETRAKTOREN | SNAKE RETRACTORS ★

FLEXIBLE RETRAKTOREN | SNAKE RETRACTORS

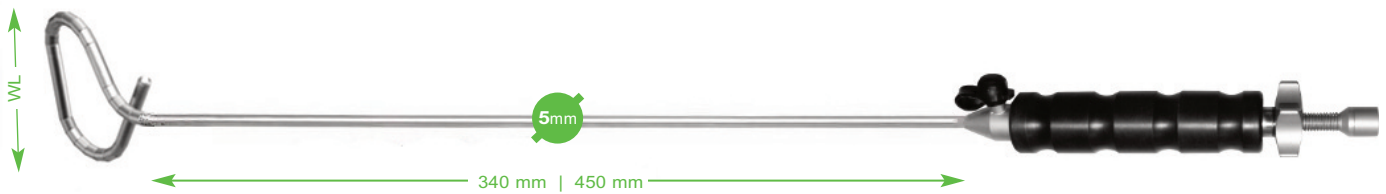

- ▶ Ideal für den Gebrauch in der Bauchhöhle zur Retraction von Organen und Gewebe
 - ▶ Atraumatisches Design der Instrumentenspitze
 - ▶ Instrumentenspülkanal am Griff
 - ▶ Integrierter Bewegungsknopf
 - ▶ Erhältlich in unterschiedlichen Designs
 - ▶ 5 mm Schaftdurchmesser und 340 / 450 mm Schaftlänge
 - ▶ Bruchsicherer, rostfreier Stahl
- ▶ *Ideal for the application in the peritoneal cavity for retraction of organs and structures*
 - ▶ *Atraumatic tip design*
 - ▶ *Instrument cleaning port on handle*
 - ▶ *Integrated articulating knob*
 - ▶ *Different styles available*
 - ▶ *5 mm sheath diameter and 340 / 450 mm sheath length*
 - ▶ *Break-proof stainless steel*

MODELLE | STYLES

13-1661

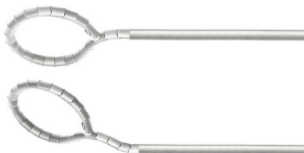
 Flexibler Retraktor, gerade, gewinkelt im Schaft
Snake retractor, straight, angled in sheath

13-1662

 gerade
straight

 Flexibler Retraktor, ringförmig, 40 mm WL, 340 mm
Snake retractor, circular, 40 mm WL, 340 mm
13-1663

 gew. Schaft
angl. sheath

13-1664R

 rechts geb.
curv. right

 Flexibler Retraktor, hakenförmig, 340 mm
Snake retractor, hooked, 340 mm
13-1664L

 links geb.
curv.



13-1665	80 mm WL	340 mm	Flexibler Retraktor, triangular, gewinkelt im Schaft <i>Snake retractor, triangular, angled in sheath</i>
13-1665-6	60 mm WL		
13-1665-45	80 mm WL	450 mm	



13-1666	80 mm WL	340 mm	Flexibler Retraktor, triangular <i>Snake retractor, triangular</i>
13-1666-6	60 mm WL		
13-1666-12	120 mm WL		
13-1666-45	80 mm WL	450 mm	

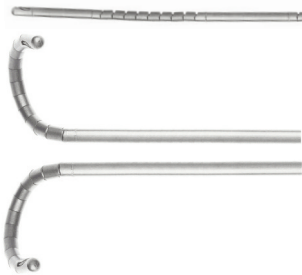

13-1667	gerade <i>straight</i>	Flexibler Retraktor, gewinkelt im Schaft, 340 mm <i>Snake retractor, angled in sheath, 340 mm</i>
13-1667R	rechts geb. <i>curv. right</i>	
13-1667L	links geb. <i>curv. left</i>	

FÄCHER RETRAKTOREN | FAN RETRACTORS

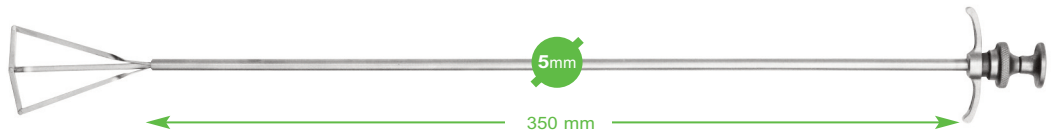

13-1670	gerade <i>straight</i>	Fächer Retraktor <i>Fan retractor</i>
13-1675	gebogen <i>curved</i>	
13-1677	gewinkelt <i>angled</i>	

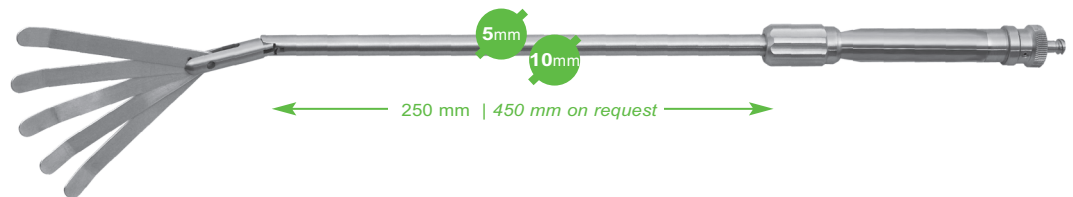

13-1671	3-Fächer <i>3-fan</i>	Ø 5 mm	Fächer Retraktor, gerade und abgewinkelt <i>Fan retractor, straight and articulating</i>
13-1672	5-Fächer <i>5-fan</i>	Ø 10 mm	

WEITERE RETRAKTOREN | *ADDITIONAL RETRACTORS*

ESOPHANGEORETRAKTOREN | *ESOPHANGEORETRACTORS*

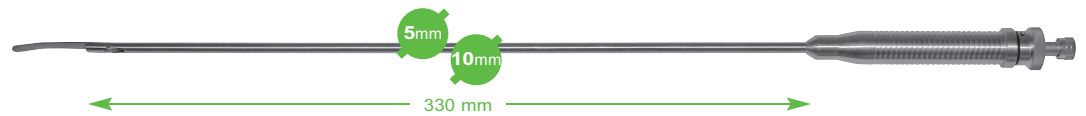

13-1668	Ø 5 mm	Esophageo Retraktor zur Applikation des Magenbandes <i>Esophageo retractor for application of the gastric band</i>
13-1668-10	Ø 10 mm	

HOURLAY RETRAKTOR | *HOURLAY RETRACTOR*

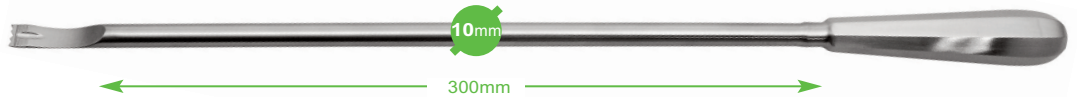

13-1669	Hourlay Finger Retraktor <i>Hourlay finger retractor</i>
----------------	---

LL INJEKTIONSNADELN | *LL INJECTION NEEDLES*

LL INJEKTIONSNADELN | *LL INJECTION NEEDLES*



13-1619	330 mm	LL Injektionsnadel, Ø 1.5 mm an Spitze <i>LL injection needle, Ø 1.5 mm at tip</i>
13-1619-26	260 mm	
13-1619-45	450 mm	

KNOTENSCHIEBER | KNOT PUSHER

KNOTENSCHIEBER | KNOT PUSHER

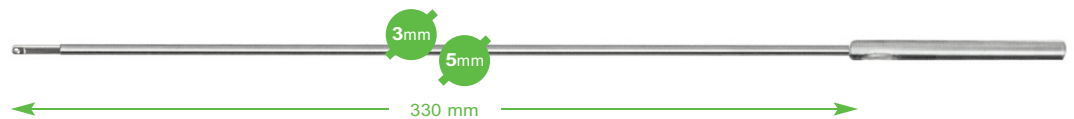

13-1617	Ø 5 mm	Knotenschieber ohne Schlitz <i>Knot pusher without slot</i>
13-1617SL		
13-1617SL-3	Ø 3 mm	Knotenschieber mit Schlitz <i>Knot pusher with slot</i>

RING APPLIKATOREN | RING APPLICATORS

RING APPLIKATOREN | RING APPLICATORS

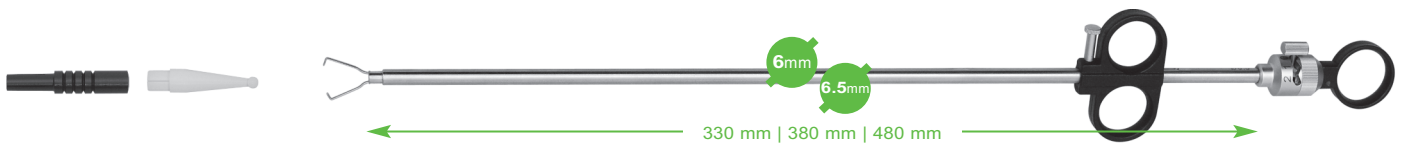

13-1618	verw. durch Ventil <i>for use through valve</i>	400 mm	Ø 6 mm	Ring Applikator zur Verwendung mit OP Laparoskop (11-1140 und 11-1145) <i>Ring applicator for use with OP-Laparoscope (11-1140 and 11-1145)</i>
13-1618OV	verw. mit Optik <i>for use with scope</i>	330 mm		
13-1618TR	für 7 mm Trokar <i>for 7 mm trocar</i>	380 mm		
13-1618-100	Ringe für 13-1618 <i>Rings for 13-1618</i>			VE 10 Stk <i>UOM 10 pcs</i>

KABEL | *CABLES*

MONOPOLARE KABEL - LAPAROSKOPIE | *MONOPOLAR CABLES - LAPAROSCOPY*



	11-1260	2.8 m	Ø 4 mm ACK Erbe T¹ Geräteanschluss <i>Generator side</i>	Ø 4 mm Instrumentenseite <i>Instrument side</i>
	11-1260-3	3 m		
	11-1260-4,5	4.5 m		
	11-1261	3 m	Ø 5 mm ACK Erbe ACC/ICC-VIO¹ Geräteanschluss <i>Generator side</i>	Ø 4 mm Instrumentenseite <i>Instrument side</i>
	11-1262	3 m	Ø 8 mm ACK Valleylab¹ Bovie¹ Geräteanschluss <i>Generator side</i>	Ø 4 mm Instrumentenseite <i>Instrument side</i>

BIPOLARE KABEL - EU FLACHSTECKER | *BIPOLAR CABLES - EU FLAT PLUG*



	13-1641	ACK 2-Banana Geräteanschluss <i>Generator side</i>	3 m	vierkant Instrumentenanschluss <i>square instrument plug</i>
		13-1643		
	13-1644	Martin¹ Berchtold¹ Geräteanschluss <i>Generator side</i>		

KABEL | CABLES

BIPOLARE KABEL - MIC STECKER | BIPOLAR CABLES - MIC PLUG

	13-1641BPW	ACK 2-Banana Geräteanschluss <i>Generator side</i>	3 m	 runder Instrumentenanschluss <i>round instrument plug</i>
	13-1643BPW	Storz¹ Erbe¹ Geräteanschluss <i>Generator side</i>		
	13-1644BPW	Martin¹ Berchtold¹ Geräteanschluss <i>Generator side</i>		

¹ Die Firmen Storz, Erbe, Martin, Bovie, Valleylab und Berchtold einschließlich ihrer Markennamen und verwandten Produkten unterliegen dem Schutz des geistigen Eigentums. Die Verwendung derer impliziert keine Zugehörigkeit oder Billigung durch diese.

¹ The companies Storz, Erbe, Martin, Bovie, Valleylab and Berchtold including their brand names and related products are protected under intellectual property laws. The use of them does not imply any affiliation with or endorsement by them.

ALPHANUMERISCHER INDEX | *ALPHANUMERIC INDEX*

REF #	SEITE PAGE	REF #	SEITE PAGE	REF #	SEITE PAGE
10-1113	51	13-1326XPI	14	13-1376XPI	23
10-1114	51	13-1327XPI	13	13-1377XPI	9
11-1260	56	13-1328XPI	16	13-1378XPI	11
11-1260UR	56	13-1329XPI	14	13-1379XPI	7
11-1261	56	13-1330XPI	10	13-1380ADG	47
11-1261UR	56	13-1331XPI	17	13-1380DG	48
11-1262	56	13-1332XPI	20	13-1380XPI	20
11-1262UR	56	13-1333XPI	23	13-1381ADG	47
11-1645XPI	34	13-1334XPI	23	13-1381DG	48
13-0530XPI	25	13-1335XPI	10	13-1381XPI	20
13-1300XPI	9	13-1336XPI	23	13-1382XPI	7
13-1301DDI	39	13-1337XPI	15	13-1383CS	41
13-1301TI-EC	37	13-1338XPI	24	13-1383TI-EC	37
13-1301XPI	7	13-1339XPI	16	13-1384CS	41
13-1302XPI	9	13-1340XPI	27	13-1384RCFI	40
13-1303XPI	9	13-1341XPI	17	13-1384TI-EC	37
13-1304XPI	26	13-1343TI-EC	37	13-1384XP	5
13-1305XPI	11	13-1343XPI	8	13-1409XPI	12
13-1306XPI	26	13-1344XPI	29	13-1411XPI	27
13-1307XPI	26	13-1345XPI	18	13-1412XPI	28
13-1308XPI	26	13-1346XPI	29	13-1413XPI	13
13-1309CI	30	13-1347XPI	32	13-1416XPI	12
13-1309XPI	30	13-1348XPI	32	13-1417XPI	21
13-1310XPI	11	13-1349XPI	33	13-1418XPI	15
13-1311XPI	8	13-1350XPI	14	13-1419XPI	28
13-1312XPI	8	13-1351XPI	33	13-1421XPI	11
13-1313XPI	8	13-1353XPI	25	13-1422XPI	29
13-1315XPI	12	13-1354XPI	10	13-1431XPI	29
13-1316XPI	12	13-1356XP	5	13-1455XPI	30
13-1317XPI	28	13-1357XP	5	13-1460CI	30
13-1318DDI	39	13-1367CS	41	13-1460TI-EC	37
13-1318DDRH	43	13-1367RCFI	40	13-1460XPI	30
13-1318TI-EC	37	13-1367XP	5	13-1461CI	30
13-1318XPI	27	13-1368CS	41	13-1461XPI	30
13-1322XPI	27	13-1368RCFI	40	13-1465CI	31
13-1323DDI	39	13-1368XP	5	13-1465XPI	31
13-1323DDRH	43	13-1369CS	41	13-1466CI	31
13-1323DDRHR	43	13-1369FRI	40	13-1466DDI	39
13-1323TI-EC	37	13-1369XP	5	13-1466DDRH	13
13-1323XPI	7	13-1375ADG	47	13-1466XPI	31
13-1324XPI	13	13-1375DG	48	13-1467CI	31
13-1325XPI	13	13-1375XPI	20	13-1467DDI	39

ALPHANUMERISCHER INDEX | *ALPHANUMERIC INDEX*

REF #	SEITE PAGE	REF #	SEITE PAGE	REF #	SEITE PAGE
13-1467DDRH	43	13-1594P	49	13-1666-12	53
13-1467XPI	31	13-1595XPI	33	13-1666-45	53
13-1468CI	31	13-1599A	48	13-1667	53
13-1468TI-EC	37	13-1600XPI	10	13-1667L	53
13-1468XPI	31	13-1605XPI	22	13-1667R	53
13-1469TI-EC	37	13-1606XPI	22	13-1668	54
13-1470XPI	34	13-1617	55	13-1669	54
13-1475XPI	34	13-1618	55	13-1670	53
13-1480XPI	34	13-1619	54	13-1671	53
13-1485XPI	34	13-1630A	46	13-1672	53
13-1490XPI	35	13-1630IWO	45	13-1675	53
13-1510XPI	15	13-1633IWO	45	13-1677	53
13-1520XPI	17	13-1634IWO	45	13-1700R	44
13-1525XPI	17	13-1635A	46	13-1700SI	44
13-1530XPI	15	13-1635IWO	45	13-1701I	44
13-1535XPI	16	13-1640A	46	13-1702I	44
13-1536XPI	22	13-1640IWO	45	13-1703I	44
13-1537XPI	22	13-1641	56	13-1704I	44
13-1540XPI	18	13-1641BPW	57	13-1705I	44
13-1541XPI	18	13-1642A	46	13-1706I	44
13-1542XPI	18	13-1642IWO	45		
13-1543XPI	18	13-1643	56		
13-1544XPI	19	13-1643BPW	57		
13-1545XPI	19	13-1644	56		
13-1546XPI	21	13-1644BPW	57		
13-1547XPI	21	13-1645IWO	45		
13-1548XPI	21	13-1646SI	45		
13-1550XPI	24	13-1647SI	45		
13-1555XPI	24	13-1650CI	32		
13-1560XPI	24	13-1650XPI	32		
13-1565XPI	25	13-1655XPI	32		
13-1570XPI	25	13-1660XPI	35		
13-1571XPI	16	13-1661	52		
13-1580XPI	19	13-1662	52		
13-1590ETSFU	50	13-1663	52		
13-1590PSFU	49	13-1664L	52		
13-1590XPI	33	13-1664R	52		
13-1591ET	50	13-1665	53		
13-1591P	49	13-1665-45	53		
13-1593ET	50	13-1665-6	53		
13-1593P	49	13-1666	53		
13-1594ET	50	13-1666-6	53		

Ackermann Instrumente GmbH

Eisenbahnstrasse 65-67
78604 Rietheim-Weilheim
Germany

Phone: +49 (0)7461 966 17 0
Fax: +49 (0)7461 966 17 70
E-Mail: info@ackermanninstrumente.de
Web: www.ackermanninstrumente.de