



Cardiovascular Instruments





Welcome to ASC Medical GmbH & Co. KG.

The company was founded by Kurt Bucher in the year 2003.

The **ASC MEDICAL** office is located in the heart of Southern Germany, Neuhausen / Tuttlingen.

ASC MEDICAL is dedicated to educating the market on new and improved techniques, implants and instrumentation.

Since the formation of **ASC MEDICAL**, we have dedicated ourselves of bringing instruments and implants at a competitive value to the Medical Market. We are proud of what we have achieved in the last 7 years and look forward to more of the same for many years to come.

When you purchase from **ASC MEDICAL**, you are guaranteed the best in quality and customer service. We not only meet your expectations, we exceed them!

This is what we set out to deliver and has since become known as the "**ASC MEDICAL Philosophy**".

On behalf of the **ASC MEDICAL** team members and our distribution partners, we thank you for your tremendous trust in the past. And with your support, we will continue to deliver the highest quality surgical instruments and implants on the market.

Kurt Bucher
President

Rib Shears	1-4
Rib Retractors, Spreaders and Spatulas	5-17
Grasping and Vesseling Clamps	18-22
Cardiovascular Forceps	23-43
Pediatric Vascular Clamps	44-48
Shunt Clamps	49
Miscellaneous	50-52

Special Note:

ASC is carrying the full range of over 18000 different surgical instruments.
Please do not hesitate to contact us for any instruments which you do not find in this catalogue.

Bone and Rib Shears
Knochen- und Rippenscheren
Cizallas para huesos y costillas



24-3001-20 20 cm / 8"
24-3001-23 23 cm / 9"

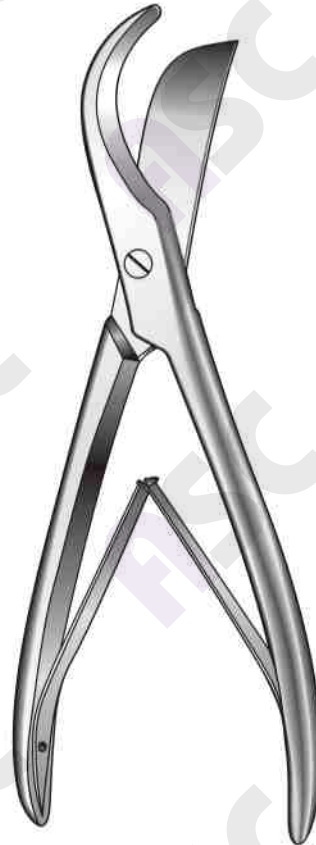

24-3005-22
22 cm / 8 1/4"



24-3010-19
19 cm / 7 3/8"



Gluck
24-3015-19 19 cm / 7 1/4"
24-3015-22 22 cm / 8 1/2"
Drawing cut

Bone and Rib Shears
Knochen- und Rippenscheren
Cizallas para huesos y costillas

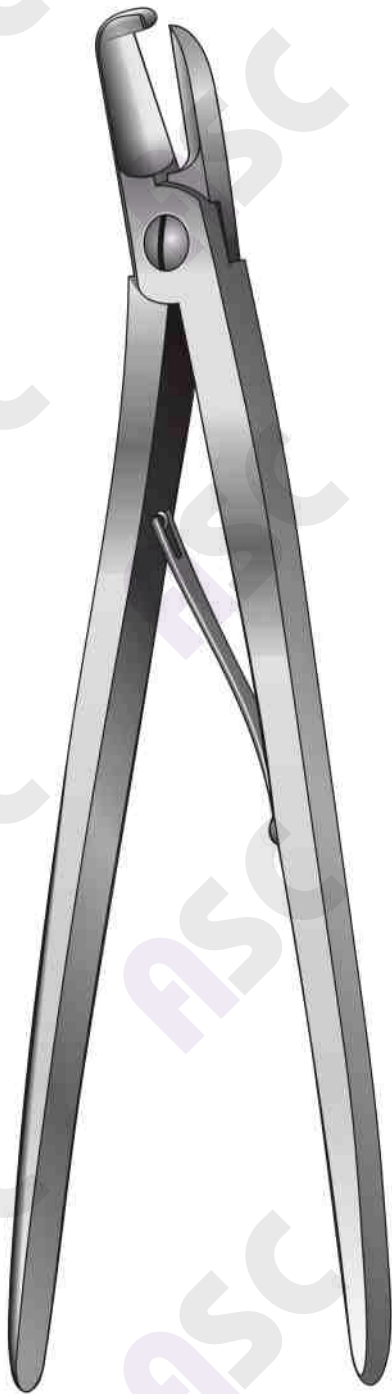

Coryllos Bethune (Collin)
24-3020-24 24 cm / 9³/₄" **24-3021-24**
24-3020-30 30 cm / 12" **24-3021-30**
For right hand For left hand



Roos
24-3025-33
33 cm / 13¹/₄"

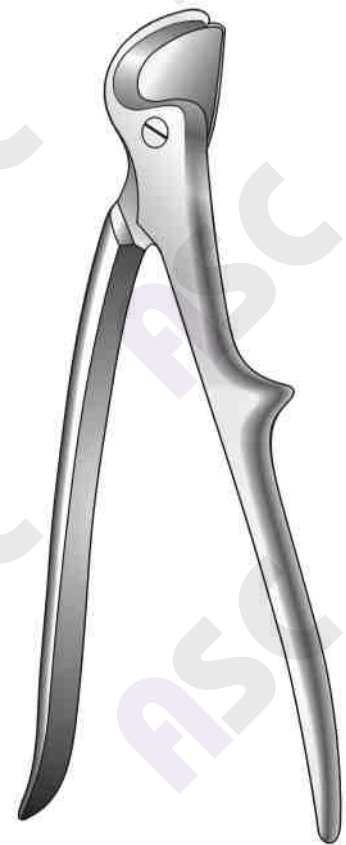

Stille
24-3030-21
21 cm / 8³/₄"

Bone and Rib Shears
Knochen- und Rippenscheren
Cizallas para huesos y costillas

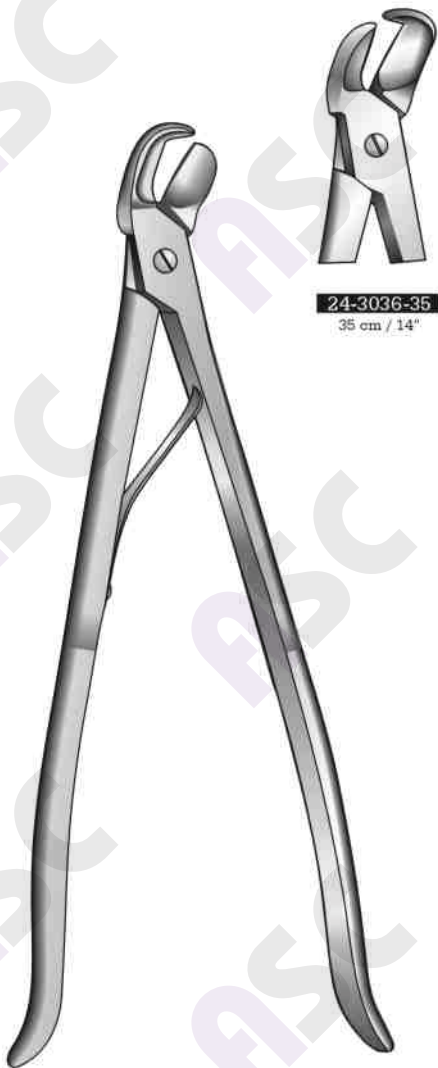

24-3036-35
35 cm / 14"

Coryllos
24-3035-35
35 cm / 14"

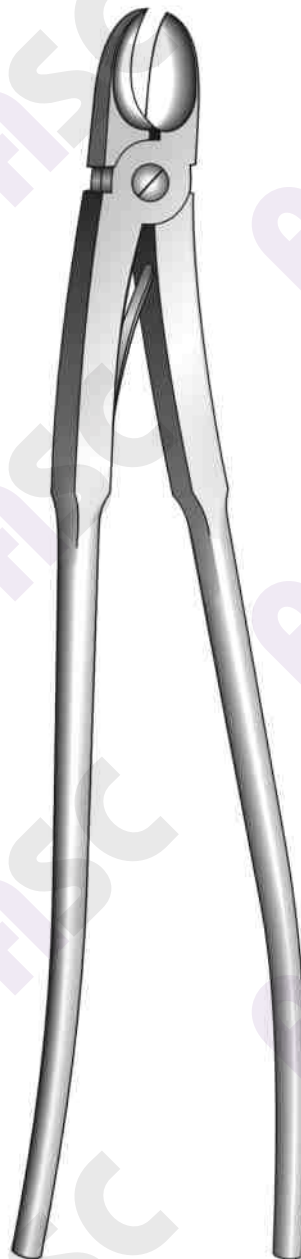

Bethune
24-3040-34
34 cm / 13 3/4"



Doyen
24-3045-19
19 cm / 7 1/2"

Rib Shears
Rippenscheren
Costotomos

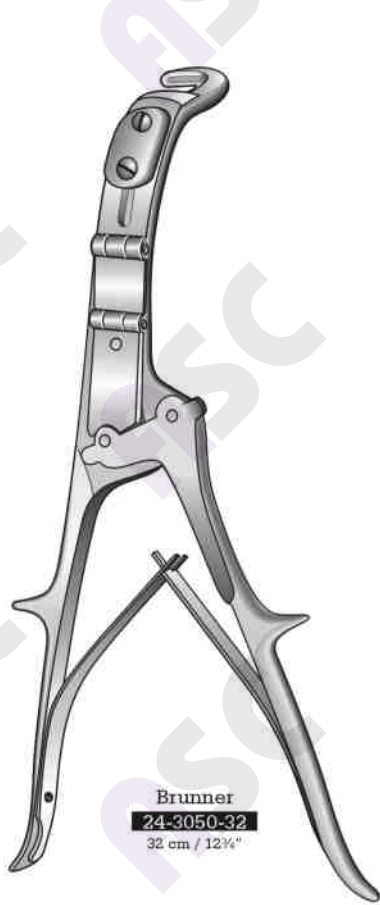

Brunner
24-3050-32
32 cm / 12 3/4"

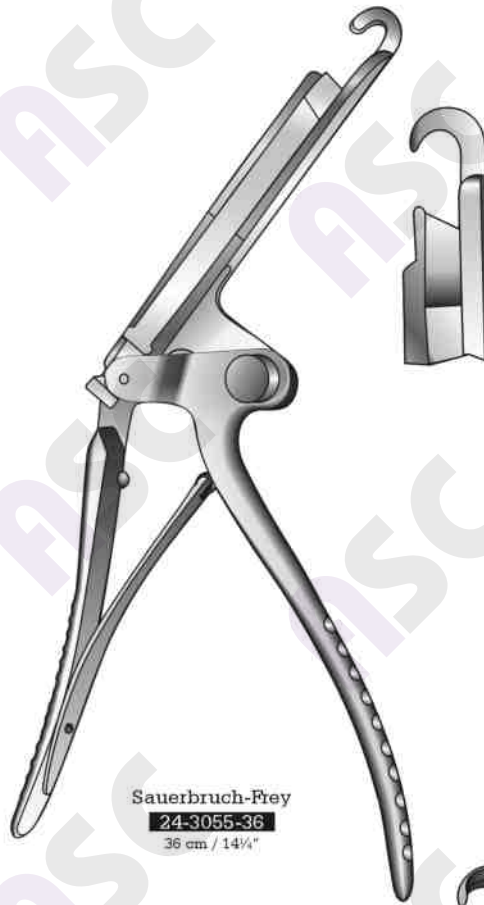

Sauerbruch-Frey
24-3055-36
36 cm / 14 1/4"

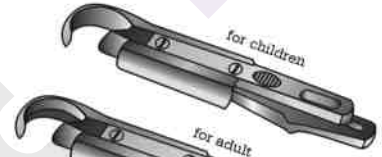

Giertz-Stille
24-3060-27
27 cm / 10 5/8"

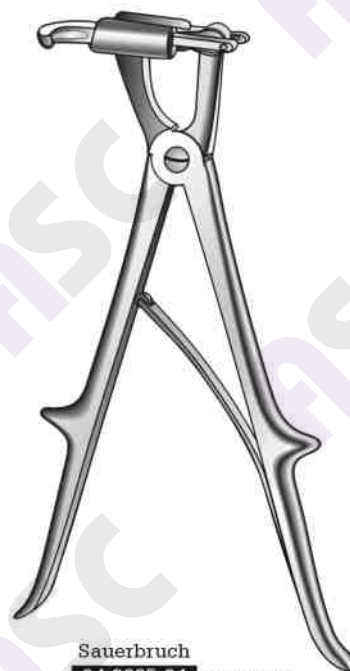

Sauerbruch
24-3065-24 24 cm / 9 1/2"
24-3065-27 27 cm / 10 5/8"
For adults

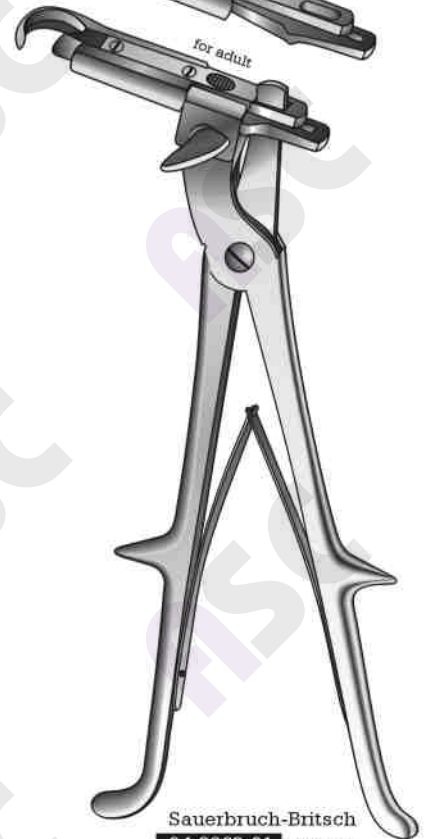

Sauerbruch-Britsch
24-3068-01 For Adult
24-3068-02 For Children
30 cm / 12"
with 2 exchangeable cutter head

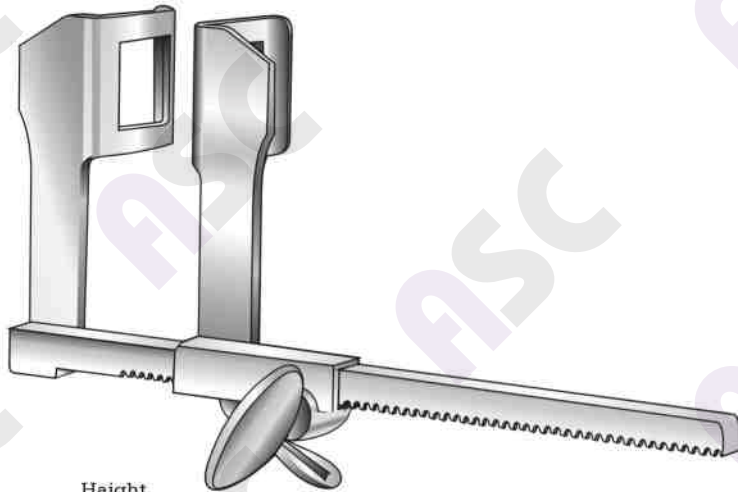

Haight
24-3070-00
30 x 30 x 90 mm

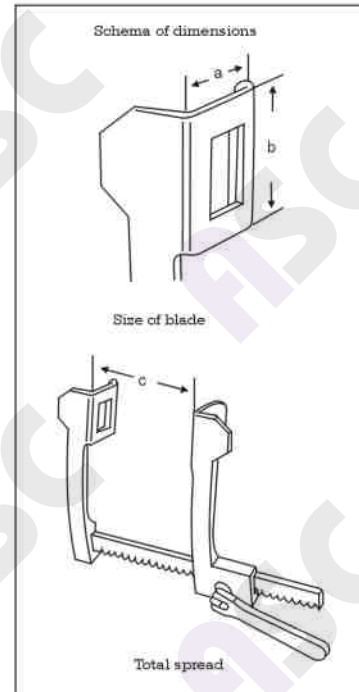

Tuffier
24-3075-00
50 x 45 x 165 mm

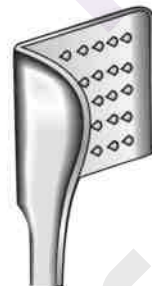

24-3076-00

Rib Spreaders
Rippensperrer
Separadores costales

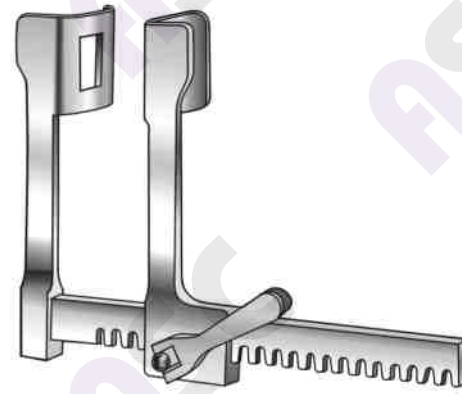
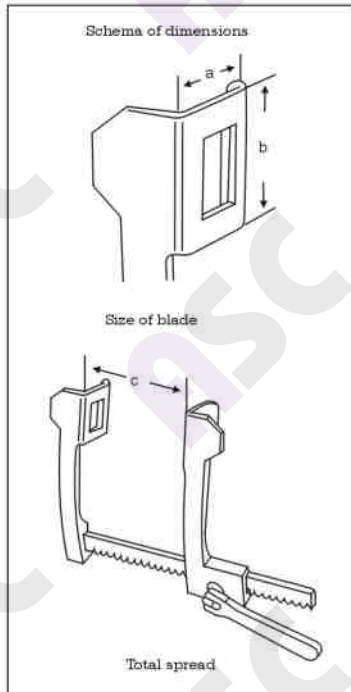

Finochietto-Baby
24-3080-00
18 x 20 x 75 mm

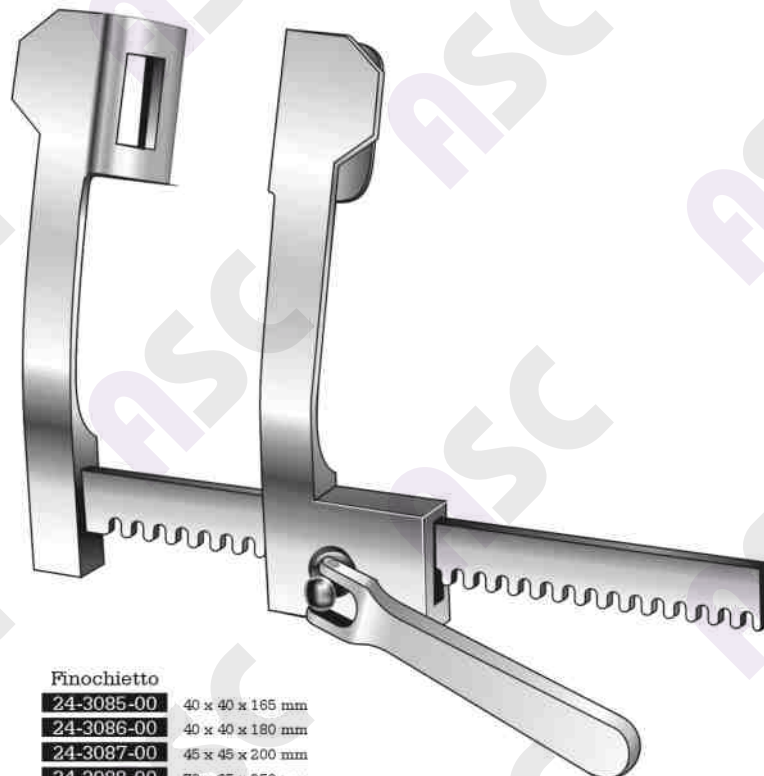

Finochietto
24-3085-00 40 x 40 x 165 mm
24-3086-00 40 x 40 x 180 mm
24-3087-00 45 x 45 x 200 mm
24-3088-00 70 x 65 x 250 mm

Rib Spreaders
Rippensperrer
Separadores costales

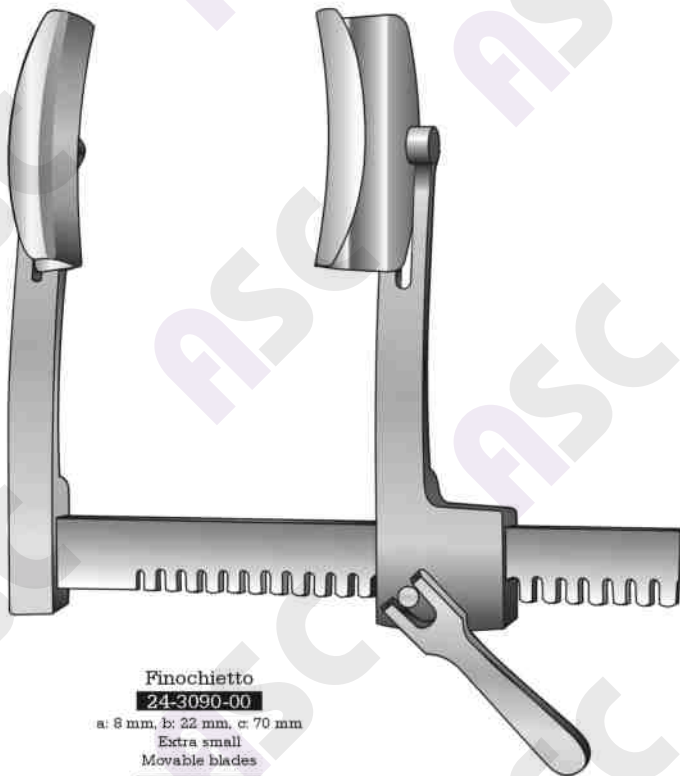

Finochietto

24-3090-00

a: 8 mm, b: 22 mm, c: 70 mm
Extra small
Movable blades

24-3091-00

a: 13 mm, b: 33 mm, c: 90 mm
For infants
Movable blades

24-3092-00

a: 15 mm, b: 50 mm, c: 90 mm
For pediatric
Movable blades

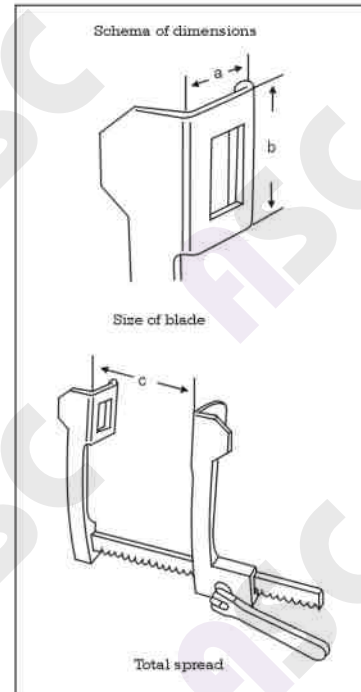

Finochietto

24-3095-00

a: 8 mm, b: 22 mm, c: 70mm
Large size, movable blades

Rib Spreaders
Rippensperrer
Separadores costales

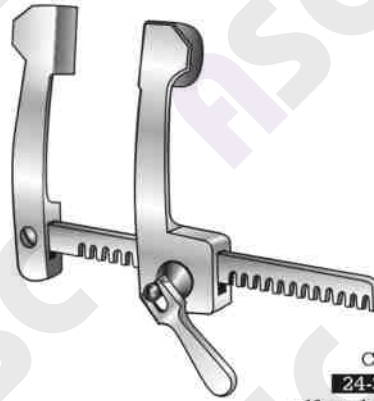
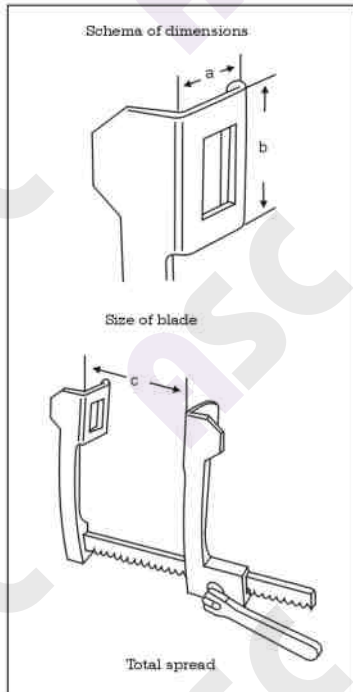

Cooley
24-3101-00
a: 12 mm, b: 16 mm, c: 95 mm
For new born

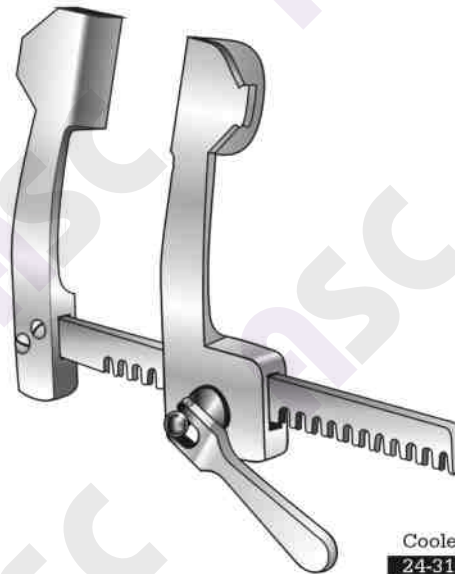

Cooley	a	b	c
24-3105-00	15 mm	30 mm	140 mm
24-3106-00	21 mm	44 mm	150 mm

Pediatric size

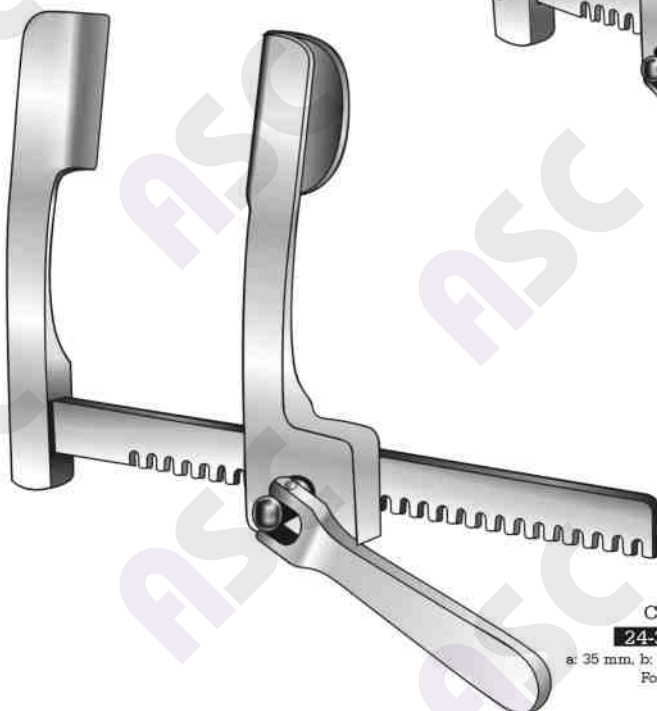

Cooley
24-3110-00
a: 35 mm, b: 50 mm, c: 200 mm
For adults

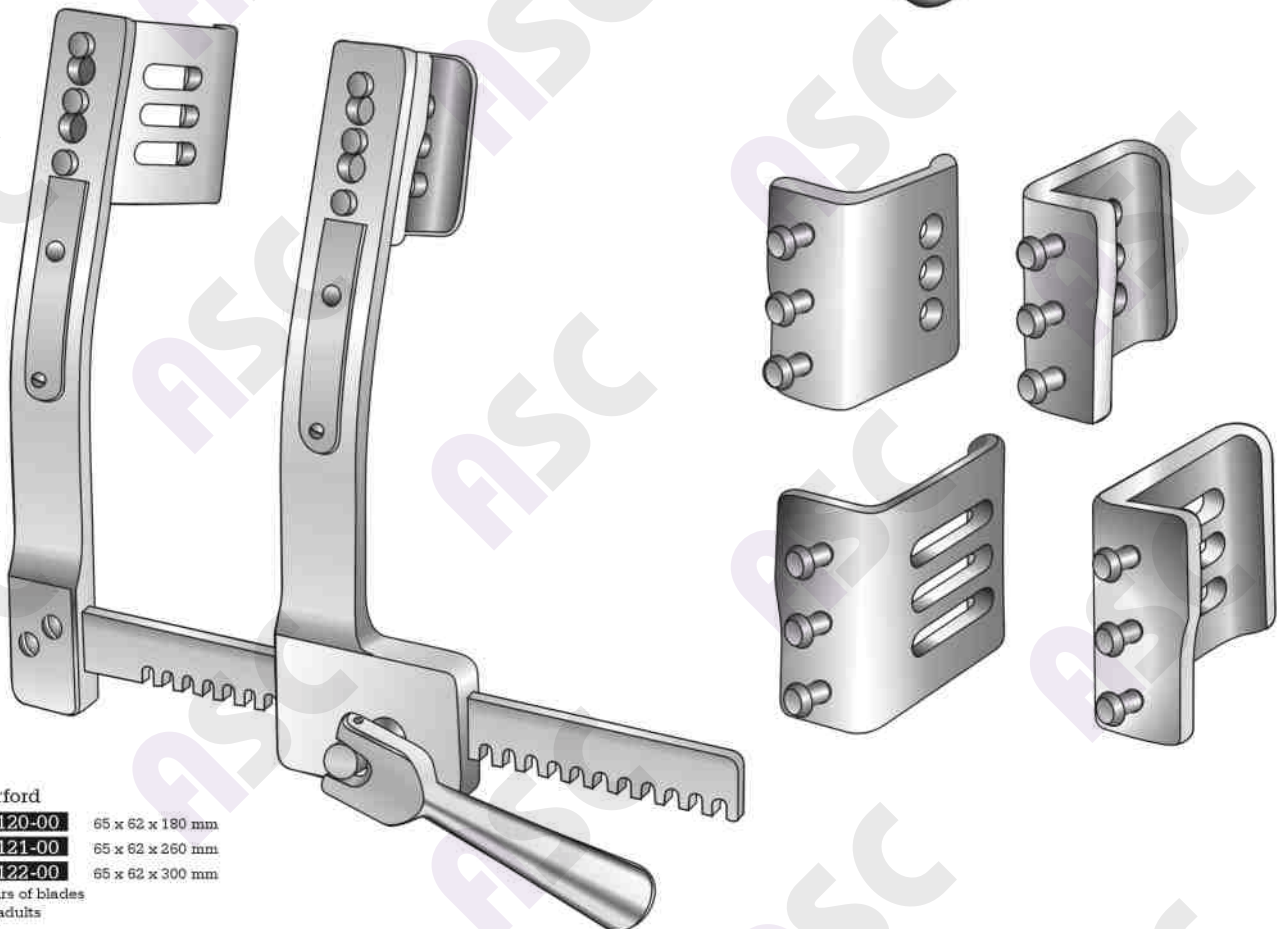
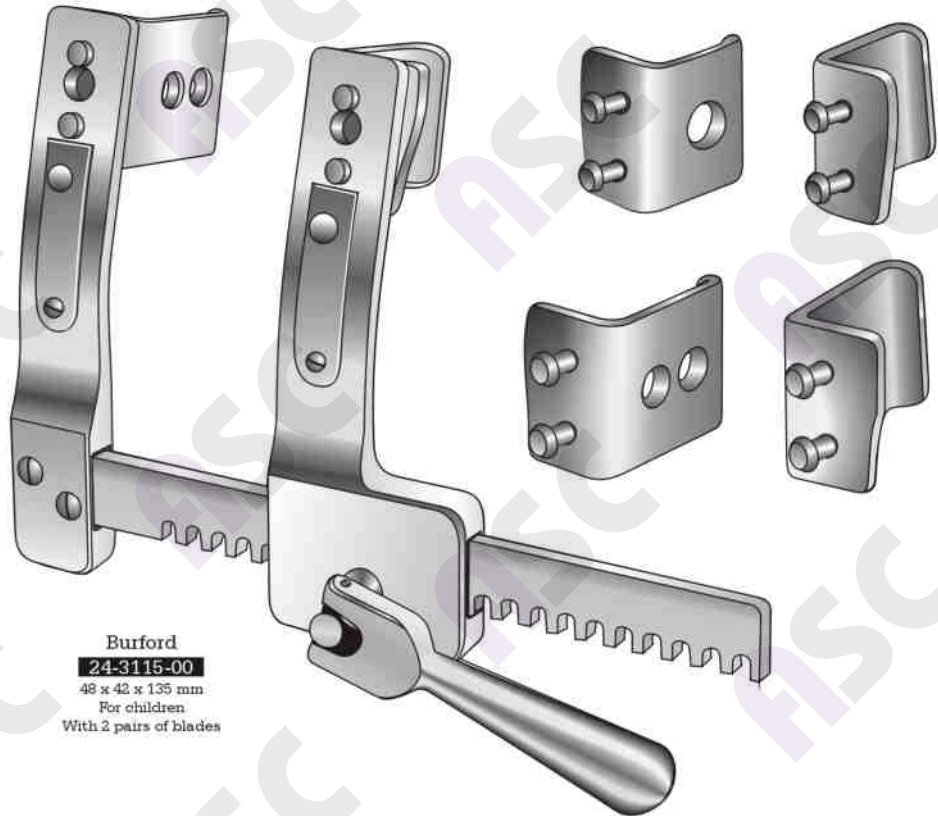
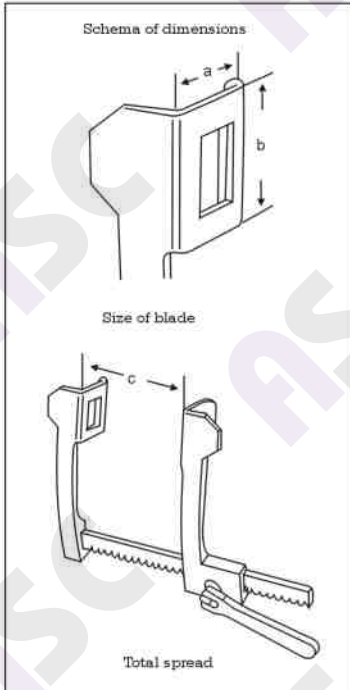

Rib Spreaders
Rippensperrer
Separadores costales

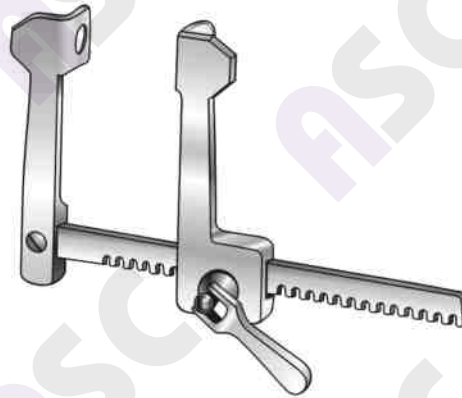
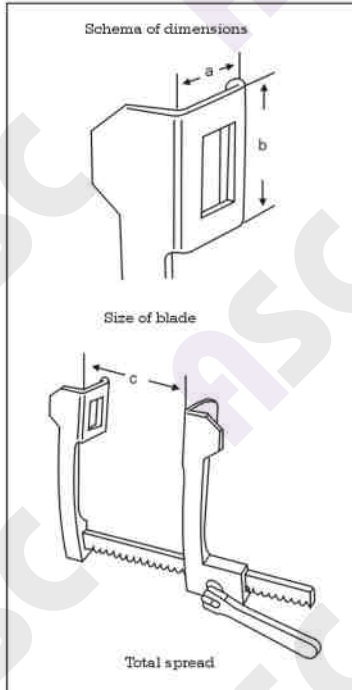

Tiny Finochietto

24-3125-00

a: 20 mm, b: 20 mm, c: 65 mm

Finochietto

24-3130-00

a: 15 mm, b: 15 mm, c: 75 mm

For babies, lateral blades, spreading

For infant

24-3131-00

a: 20 mm, b: 15 mm, c: 75 mm

24-3132-00

a: 25 mm, b: 20 mm, c: 50 mm

24-3133-00

a: 25 mm, b: 20 mm, c: 85 mm

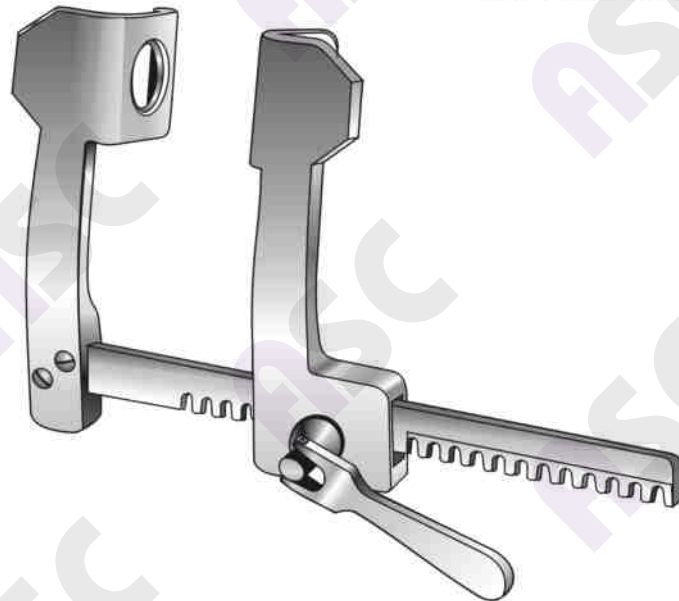

Finochietto

24-3135-00

a: 31 mm, b: 31 mm, c: 100 mm

For babies, lateral blades, spreading

For infant

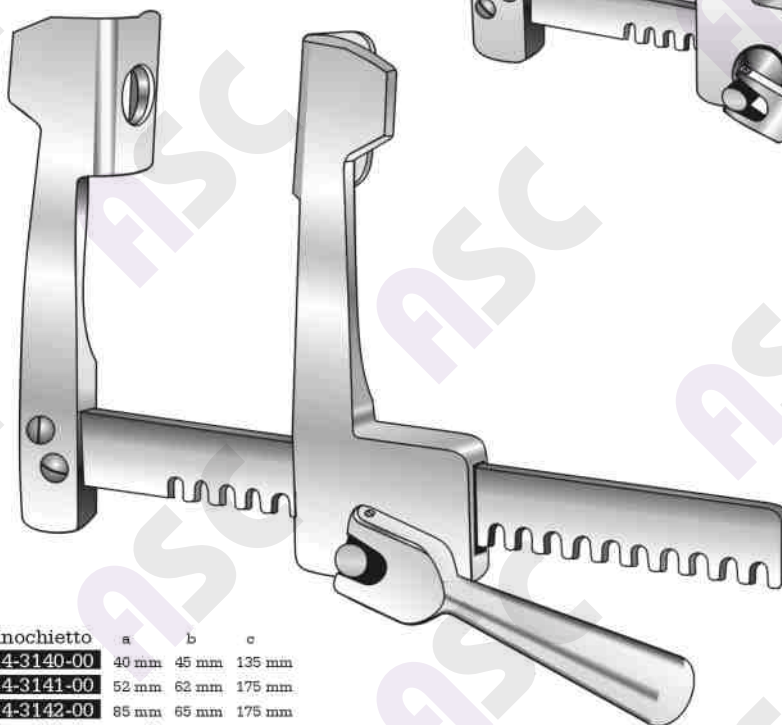

Finochietto	a	b	c
24-3140-00	40 mm	45 mm	135 mm
24-3141-00	52 mm	62 mm	175 mm
24-3142-00	85 mm	65 mm	175 mm

Lateral blades, spreading

Rib Spreaders
Rippensperrer
Separadores costales

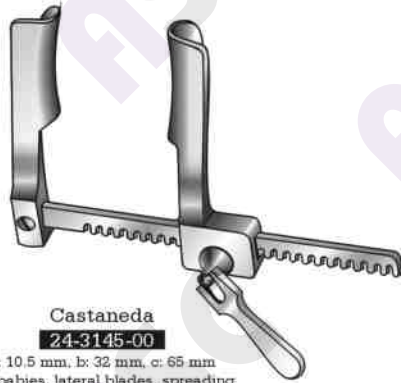

Castaneda
24-3145-00
a: 10.5 mm, b: 32 mm, c: 65 mm
For babies, lateral blades, spreading

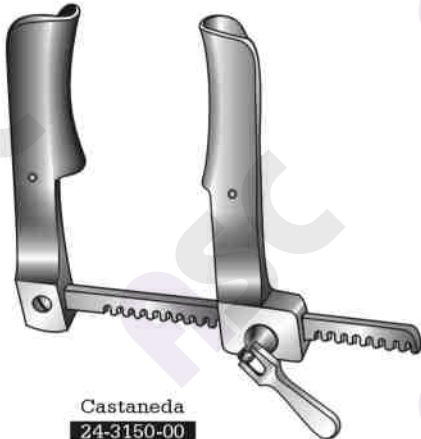
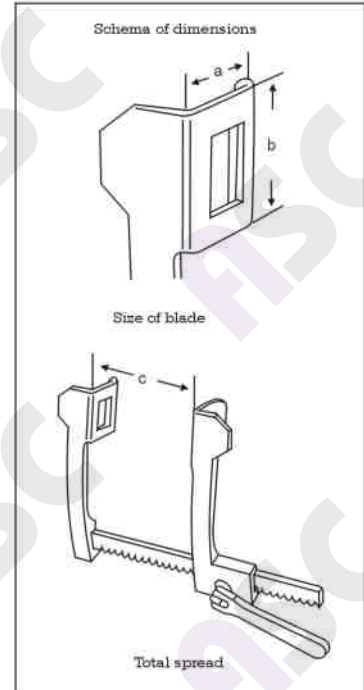

Castaneda
24-3150-00
a: 12 mm, b: 45 mm, c: 70 mm
For infants, lateral blades, spreading



Castaneda
24-3155-00
a: 15 mm, b: 60 mm, c: 120 mm
For infants, lateral blades, spreading

Rib and Sternal Retractors
 Rippensperrer, Sternumspreizer
 Separadores costales y esternales

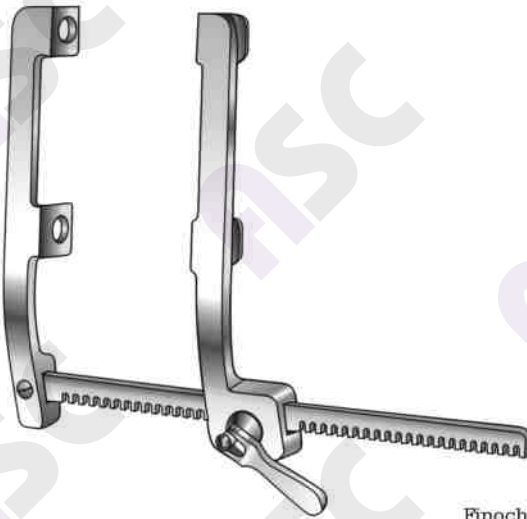
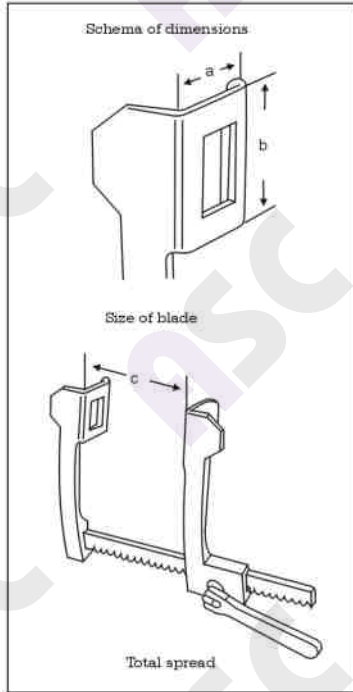

Finochietto (modif)
24-3160-00
 a: 14 mm, b: 15 mm, c: 120 mm
 Lateral blades, spreading

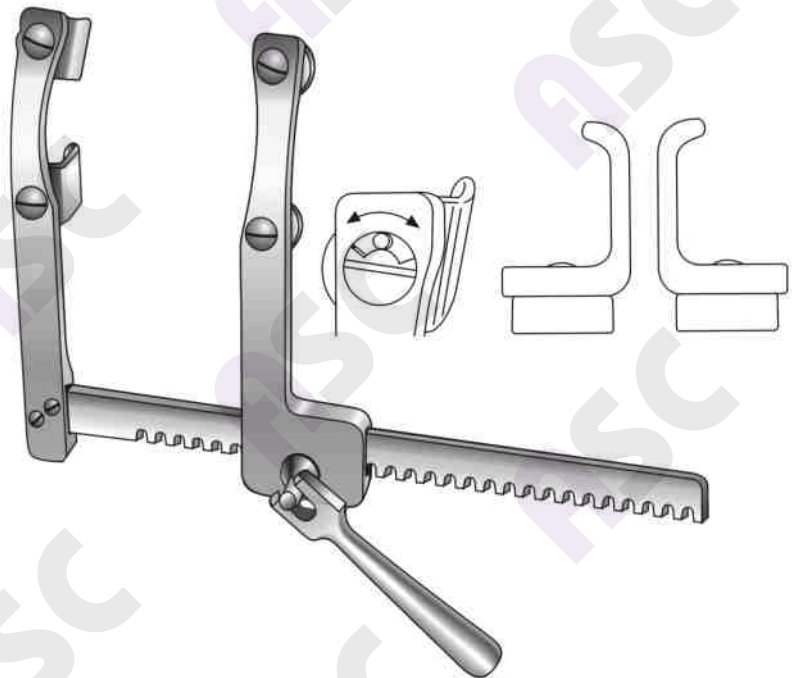

Morse-Favaloro
24-3165-00
 a: 17 mm, b: 22 mm, c: 160 mm
 For children, 4 movable blades, spreading

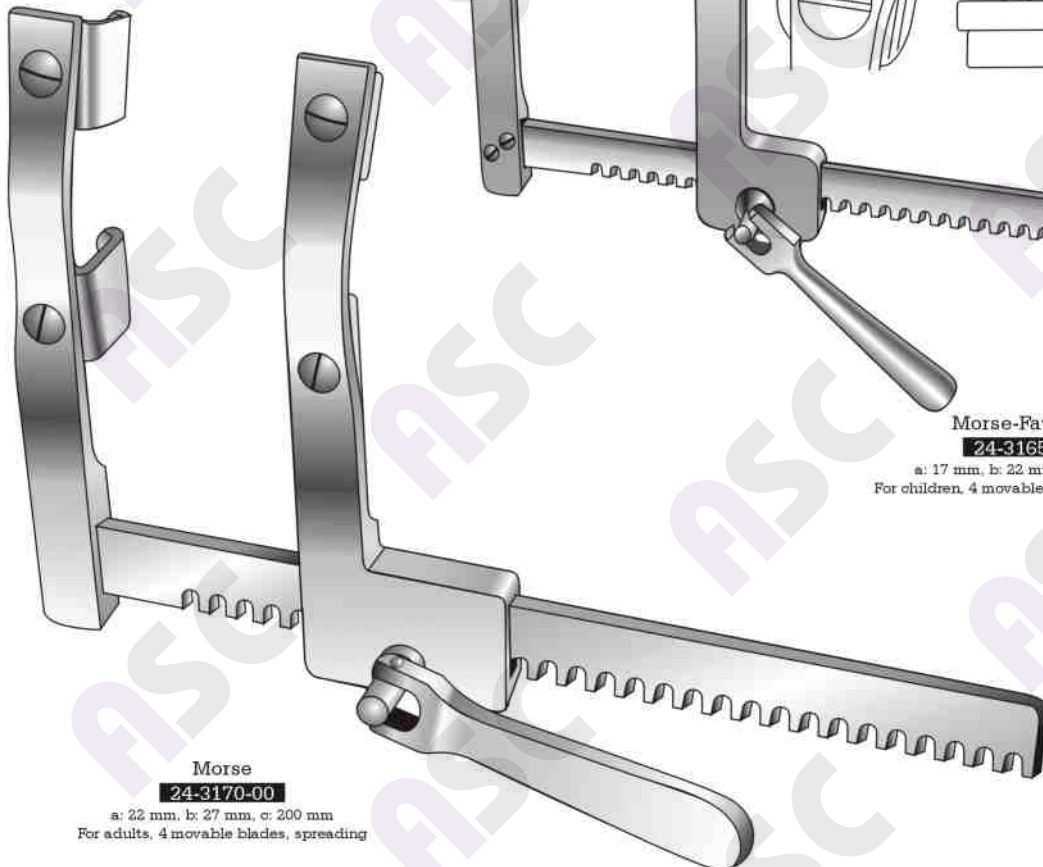

Morse
24-3170-00
 a: 22 mm, b: 27 mm, c: 200 mm
 For adults, 4 movable blades, spreading

Rib Retractors
Rippensperrer
Separadores costales



24-3176-00
30 x 30 mm
Lateral blades
Fig. 1



24-3177-00
40 x 40 mm
Lateral blades
Fig. 2



24-3178-00
50 x 50 mm
Lateral blades
Fig. 3

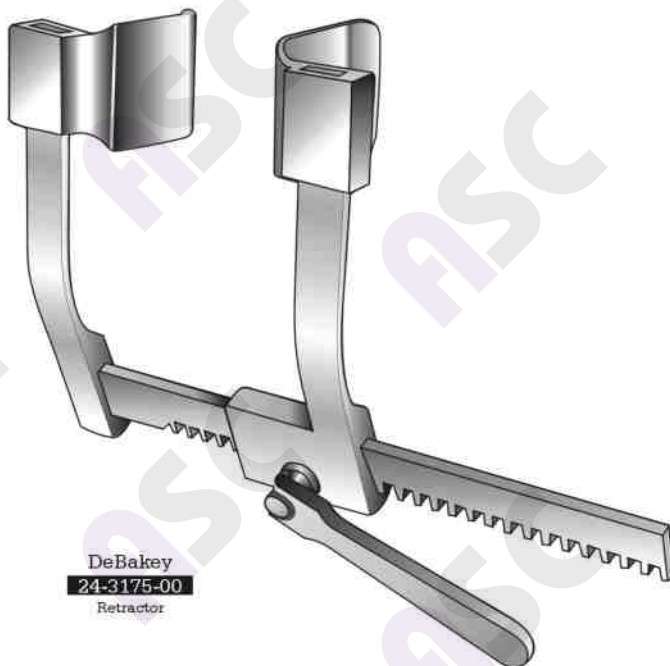
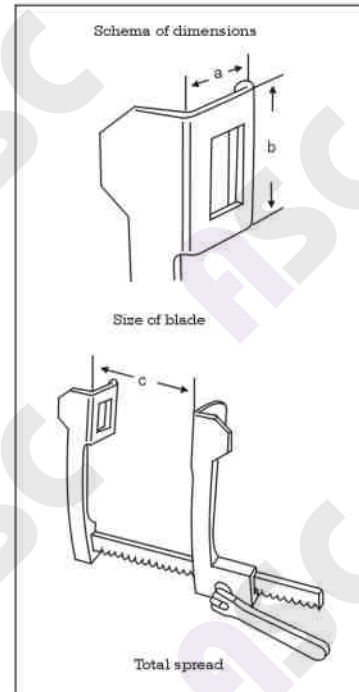

DeBakey
24-3175-00
Retractor

De Bakey
24-3179-00
Set of one retractor & three blades
Spreading 150 mm

Rib Retractors
Rippensperrer
Separadores costales

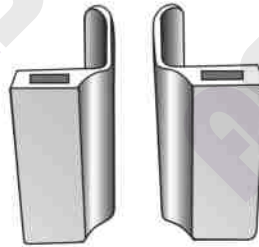
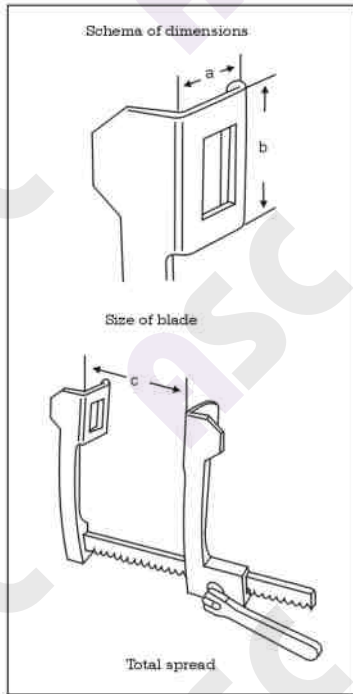

24-3181-00
60 x 60 mm
Lateral blades
Fig. 1

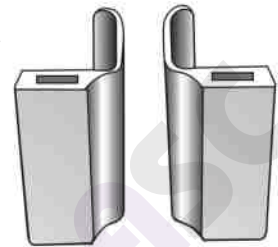

24-3182-00
50 x 80 mm
Lateral blades
Fig. 2



24-3183-00
40 x 100 mm
Lateral blades
Fig. 3

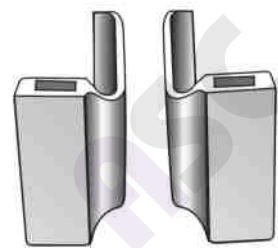

24-3184-00
80 x 60 mm
Lateral blades
Fig. 4



24-3185-00
50 x 66 mm
Lateral blades
Fig. 5

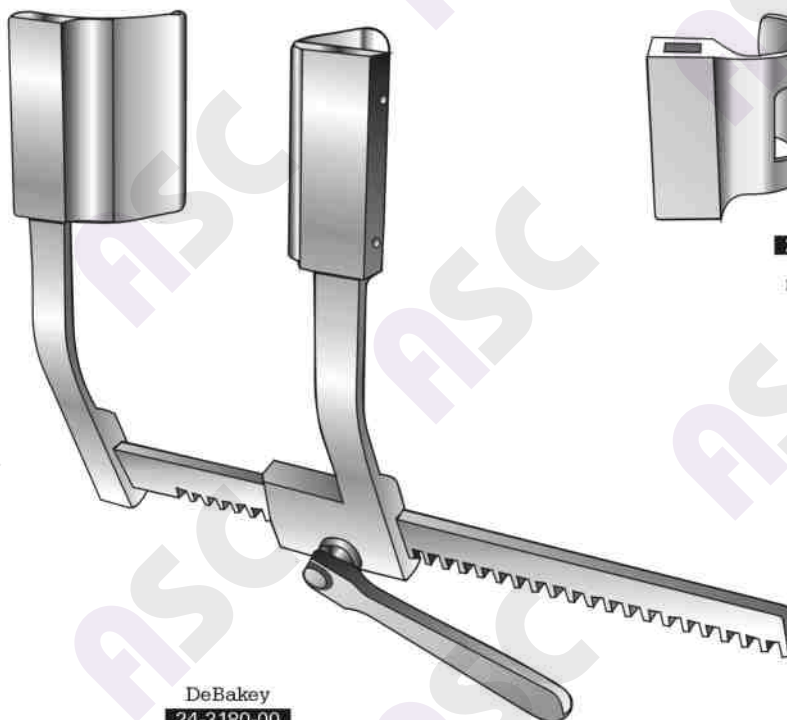

DeBakey
24-3180-00
Retractor with 3 pairs of
blades spreading 200 mm

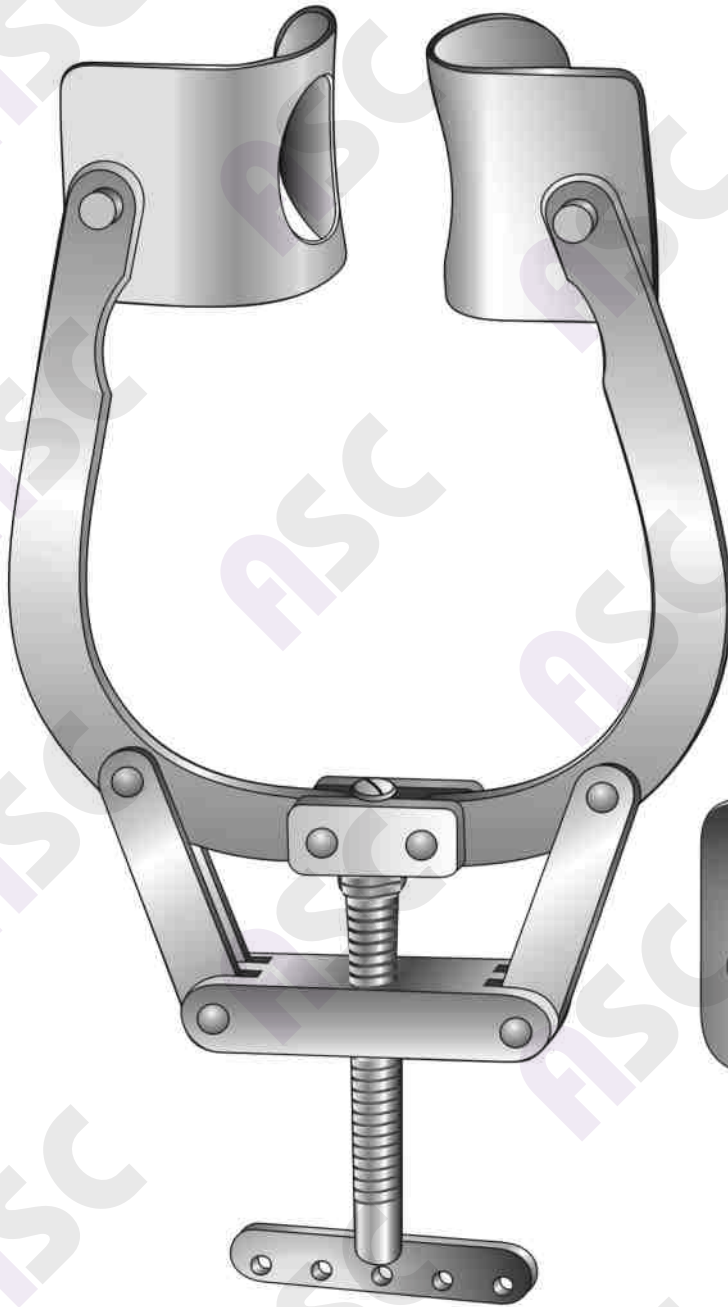

24-3190-00
Mercedes retractor



24-3191-00
49 x 69 mm
Fig. 1



24-3192-00
70 x 75 mm
Fig. 2

24-3193-00
Complete set
one retractor &
one pair of blades each

Rib Contractors
Rippenkontraktoren
Aproximadores para costillas

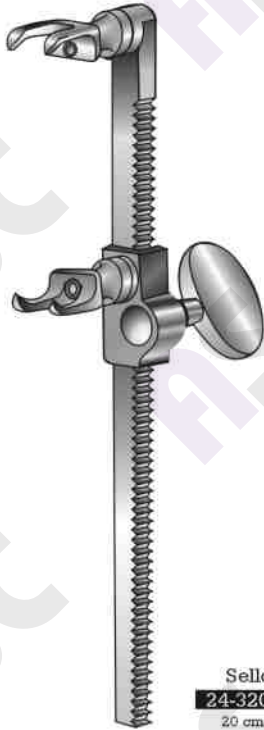

Sellors
24-3200-20
20 cm / 8"

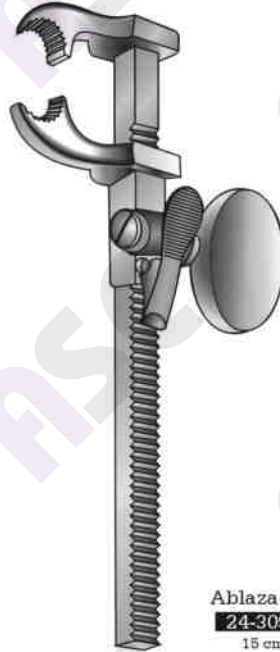

Ablaza-Morse
24-3095-15
15 cm / 6"

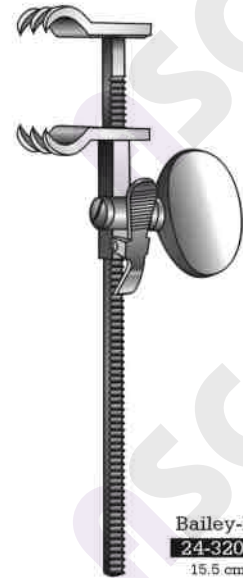

Bailey-Baby
24-3203-15
15.5 cm / 6"



Bailey
24-3205-20
20 cm / 8"
Short claws



Bailey-Gibbon
24-3208-20
20 cm / 8"
Long claws

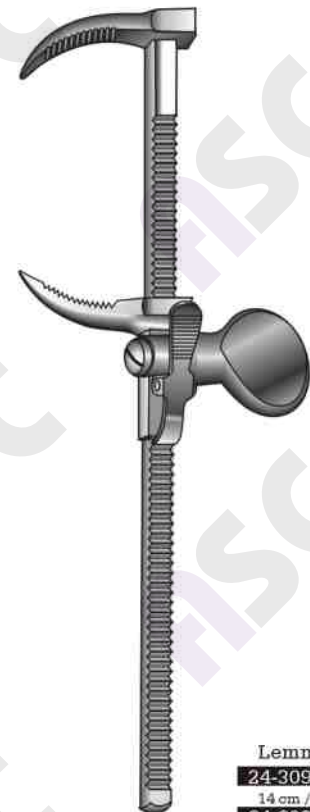

Lemmon
24-3098-14
14 cm / 5½"
24-3098-18
18 cm / 7"
Sternum-approximator
For adults

Rib Contractors, Spatulas
Rippenkontraktoren, Spatel
Aproximadores para costillas, Espátulas



Lung Grasping Forceps, Blood Vessel Clamps
Lungenfasszangen, Gefäßklemmen
Pinzas para coger el pulmón, Clamps vasculares



Lovelace
24-3230-20
20 cm / 8"

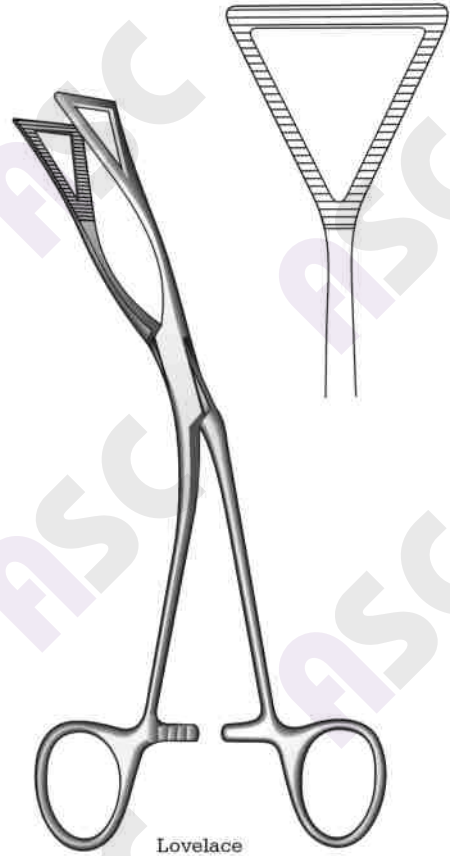

Lovelace
24-3235-20
20 cm / 8"
Laterally Curved



Johns Hopkins
22 cm / 8 3/4"



24-3240-22



24-3241-22

Bronchus Clamps
Bronchusklemmen
Pinzas bronquiales



Sarot
23 cm / 9"

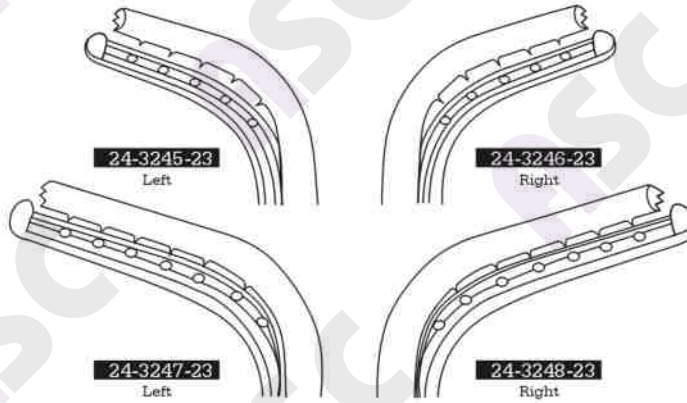

24-3245-23
Left

24-3246-23
Right

24-3247-23
Left

24-3248-23
Right

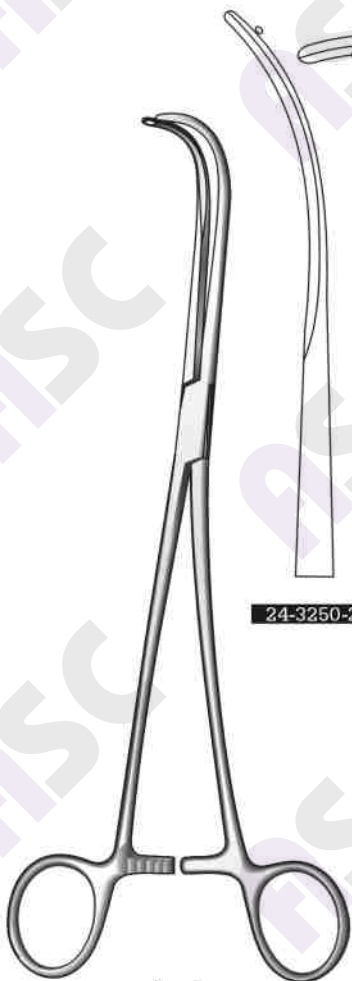

Semb
24 cm / 9 1/2"



24-3250-24

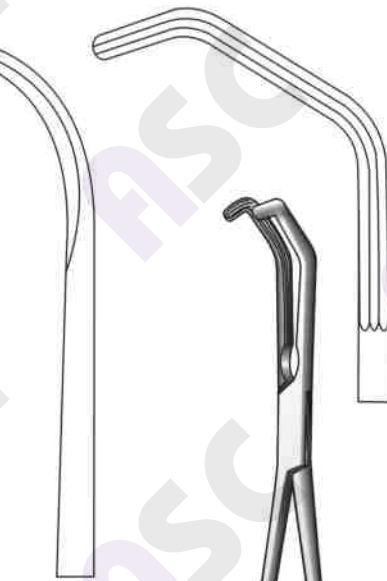

24-3251-24



Price-Thomas
24-3255-22
22 cm / 8 3/4"



24-3260-22

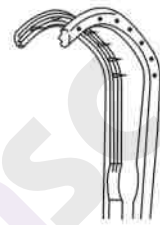

24-3261-22



Price-Thomas
22 cm / 8 3/4"

Blood Vessel Clamps
Gefäßklemmen
Clamps vasculares

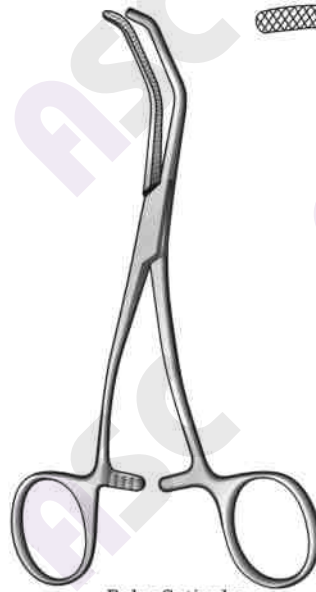

24-3265-15
15 cm / 6"

Baby-Satinsky



Satinsky
26.5 cm / 10 1/2"

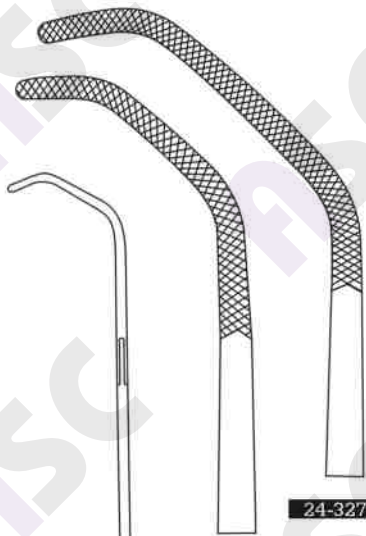

24-3271-26

24-3270-26

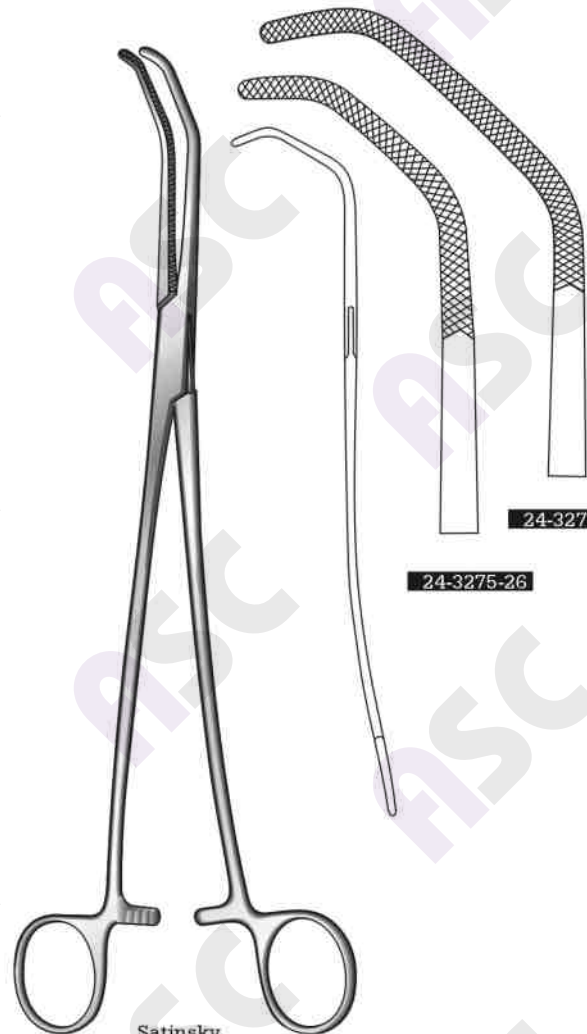

Satinsky
26.5 cm / 10 1/2"

24-3276-26

24-3275-26



Aorta Clamps
Aortaklemmen
Clamps aorta



24-3295-15
15 cm / 6"
14 mm

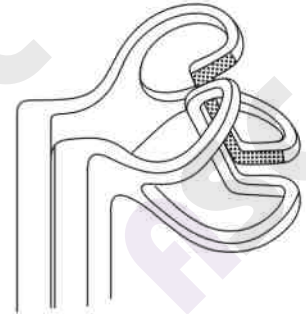

24-3301-20
190 x 19 mm



Blalock



24-3295-20
20 cm / 8"
18 mm

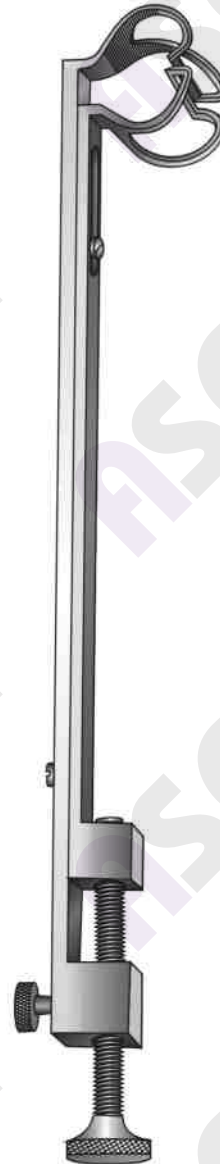

Johns Hopkins
20 cm / 8"

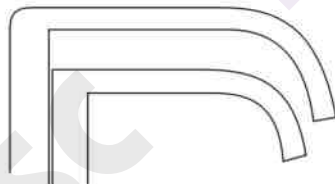

24-3295-25
25 cm / 10"
23 mm

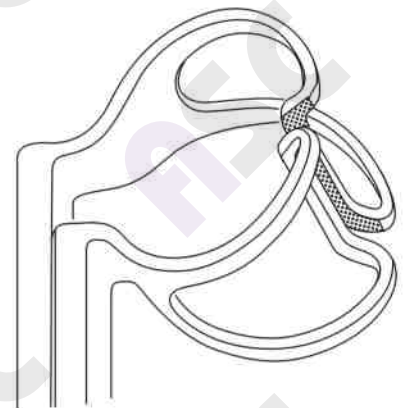

24-3302-20
250 x 25 mm

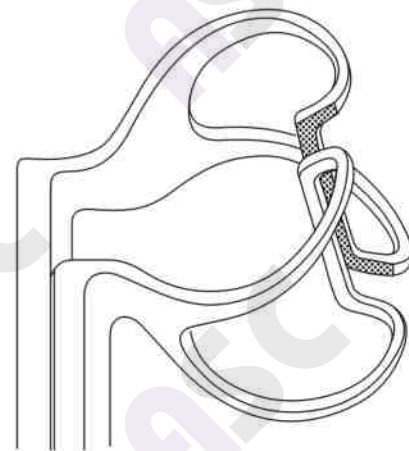

24-3303-20
320 x 32 mm

Atrauma Tissue Forceps
Atrauma Pinzetten
Pinzas de disección atrauma

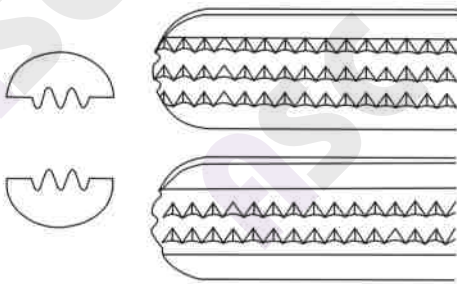

Toothing according to De Baakey:
The traditional ATRAUMA clamps. Apart from Cardio-Vascular Surgery, These are also approved for other atraumatic applications and surgery techniques. Firm and precise seizing of tissues. Safe and delicately controlled clamping effect.

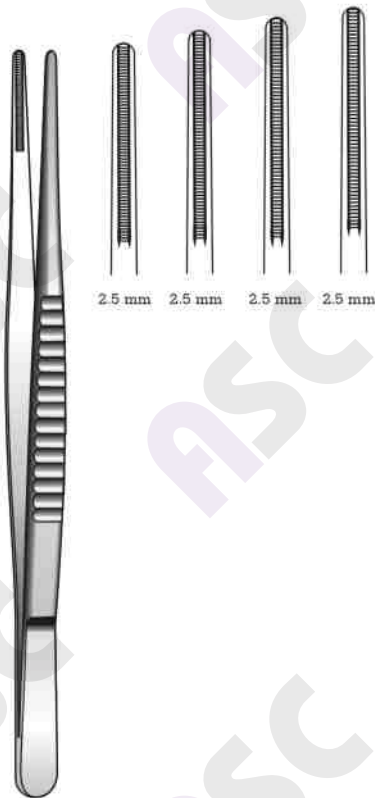
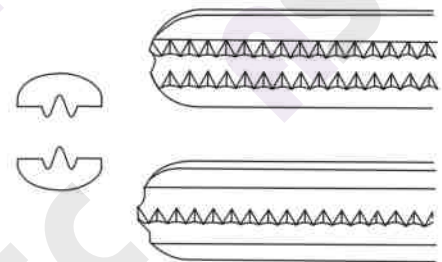

2.5 mm 2.5 mm 2.5 mm 2.5 mm

- De Baakey**
- 24-3305-16** 16 cm / 6 1/4"
 - 24-3305-20** 20 cm / 8"
 - 24-3305-24** 24 cm / 9 1/2"
 - 24-3305-30** 30 cm / 12"

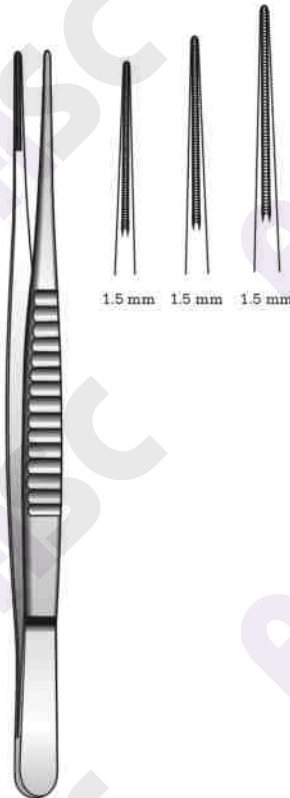

1.5 mm 1.5 mm 1.5 mm

- De Baakey**
- 24-3310-16** 16 cm / 6 1/4"
 - 24-3310-20** 20 cm / 8"
 - 24-3310-24** 24 cm / 9 1/2"

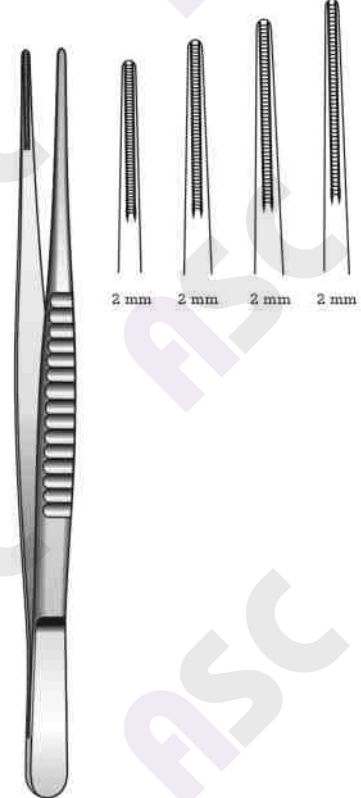

2 mm 2 mm 2 mm 2 mm

- De Baakey**
- 24-3315-16** 16 cm / 6 1/4"
 - 24-3315-20** 20 cm / 8"
 - 24-3315-24** 24 cm / 9 1/2"
 - 24-3315-30** 30 cm / 12"

Vascular Forceps, Bulldog Clamps
 Gefäßpinzetten, Bulldogklemmen
 Pinzas de disseccion Vascular, Clamps Bulldog

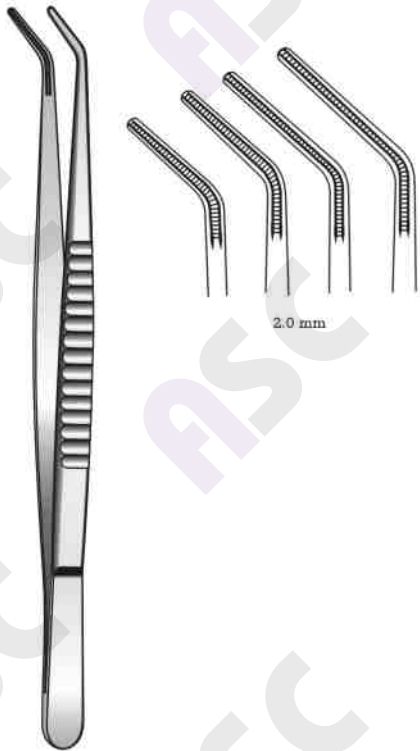

De Bakley

24-3320-16	16 cm / 6 1/4"
24-3320-20	20 cm / 8"
24-3320-24	24 cm / 9 1/4"
24-3320-30	30 cm / 12"

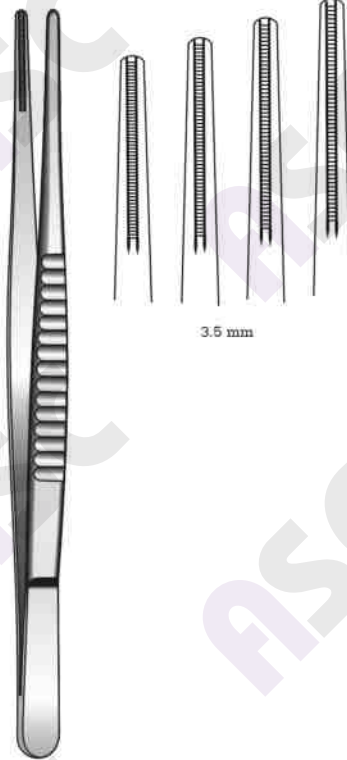

De Bakley

24-3325-16	16 cm / 6 1/4"
24-3325-20	20 cm / 8"
24-3325-24	24 cm / 9 1/4"
24-3325-30	30 cm / 12"

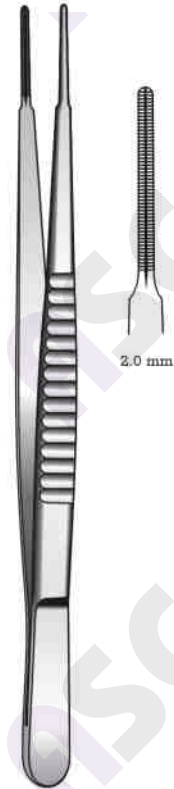

Cooley

24-3330-16	16 cm / 6 1/4"
24-3330-20	20 cm / 8"

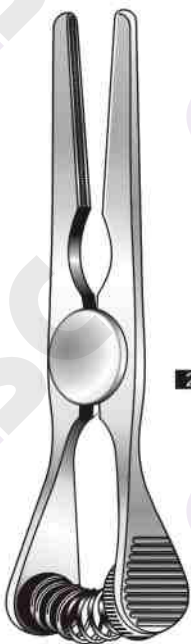

Glover



24-3335-06	6 cm / 2 1/2"	24-3335-07	7 cm / 2 3/4"	24-3335-09	9 cm / 3 1/4"	24-3335-11	11 cm / 4 1/2"	24-3340-05	5.5 cm / 2 1/4"	24-3340-06	6.5 cm / 2 3/4"	24-3340-08	8.5 cm / 3 1/2"	24-3340-10	10.5 cm / 4 1/2"
------------	---------------	------------	---------------	------------	---------------	------------	----------------	------------	-----------------	------------	-----------------	------------	-----------------	------------	------------------

Glover

Atrauma Bulldog Clamps, Atrauma Haemostatic Forceps
Atrauma Bulldogklemmen, Atrauma Arterienklemmen
Pinzas para bulldog clamps y hemostáticas atrauma

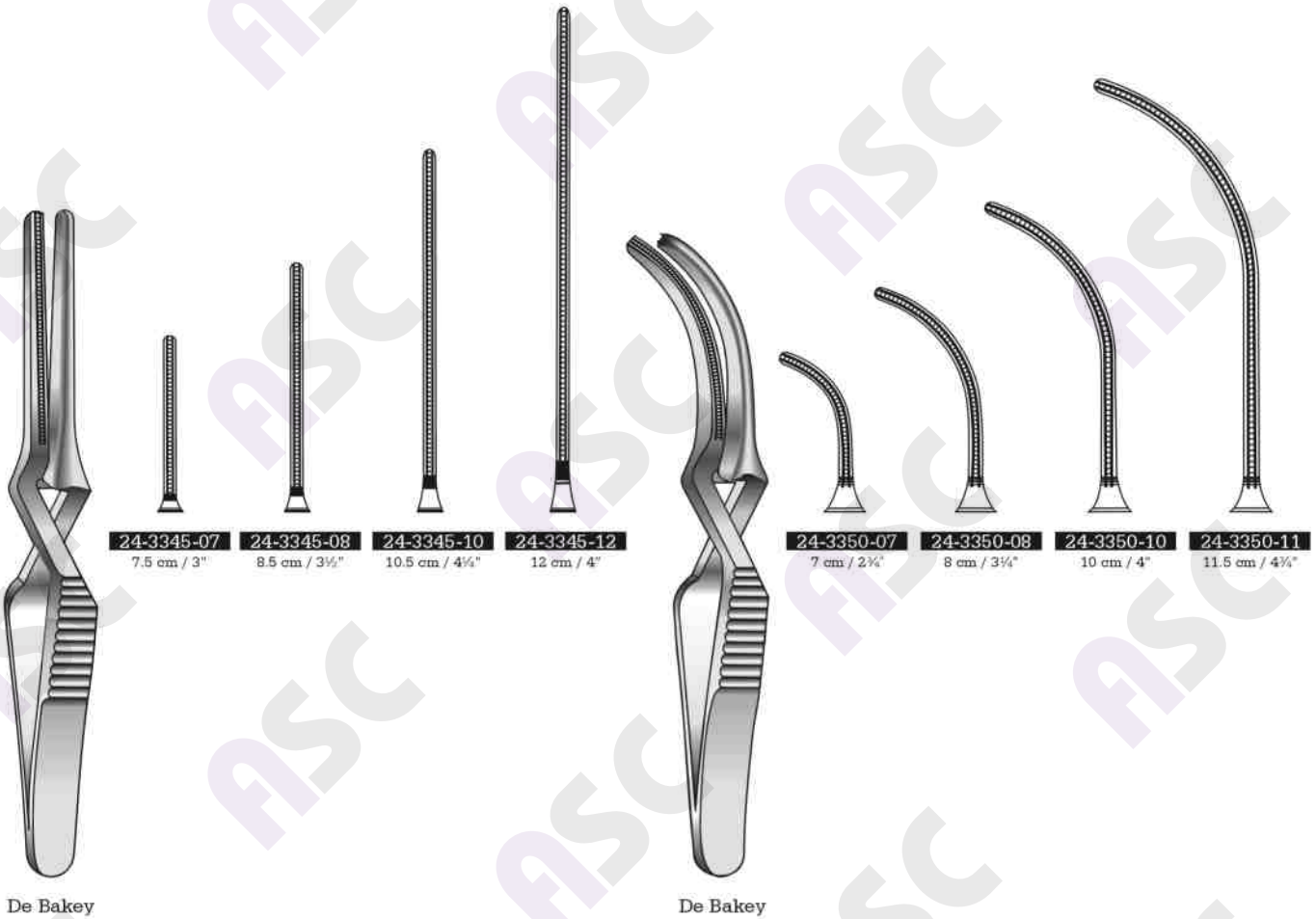

De Bakey

De Bakey



De Bakey-Mosquito

- De Bakey-Crile
24-3360-14 Straight
24-3361-14 Curved
 14 cm / 5 1/2"
 De Bakey-Crile-Rankin
24-3365-16 Straight
24-3366-16 Curved
 16 cm / 6 1/4"

Atrauma Haemostatic Forceps, Atrauma Cardiovascular Forceps
 Atrauma Arterienklemmen, Atrauma Kardiovaskularklemmen
 Atrauma hemostáticas pinzas, Atrauma pinzas-clamps cardiovasculares

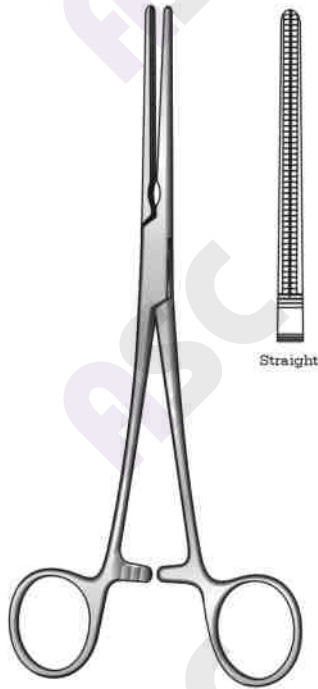

Straight

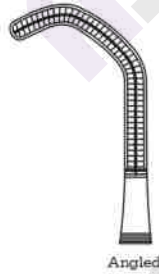

Angled



Curved

De Bakey-Pean

24-3370-16	16.5 cm / 6½"	24-3371-16	
24-3370-18	18.5 cm / 7¼"	24-3371-18	
24-3370-20	20.5 cm / 8"	24-3371-20	
24-3370-26	26 cm / 10¼"	24-3371-26	
24-3370-28	28 cm / 11"	24-3371-28	

Straight

Angled

De Bakey-Pean

24-3375-16	16.5 cm / 6½"
24-3375-18	18.5 cm / 7¼"
24-3375-20	20.5 cm / 8"
24-3375-26	26 cm / 10¼"
24-3375-28	28 cm / 11"

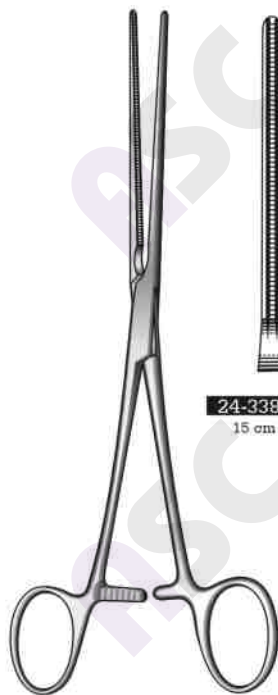

Bainbridge
Straight

24-3380-15
15 cm / 6"



24-3380-18
18 cm / 7"



Bainbridge
Curved

24-3385-15
15 cm / 6"

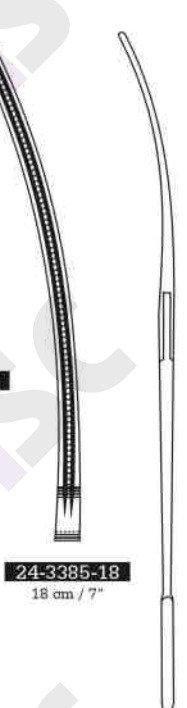

24-3385-18
18 cm / 7"

Atrauma Cardiovascular Forceps
Atrauma Cardioaskular klemmen
Atrauma pinzas-clamps cardiovasculares



De Bakey
24-3390-12
12 cm / 4 3/4"

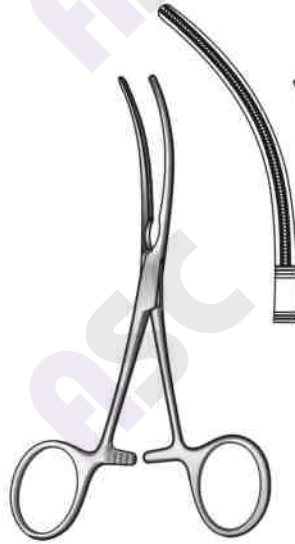

De Bakey
24-3395-11
11 cm / 4 1/4"

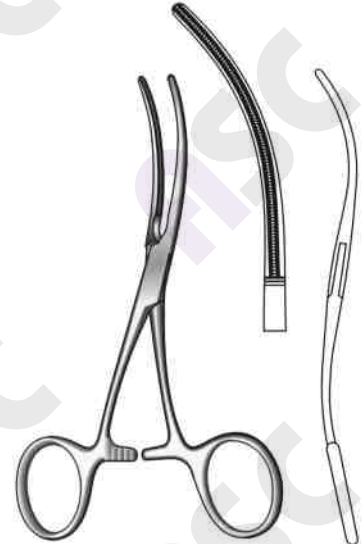

De Bakey
24-3401-12
12 cm / 4 3/4"

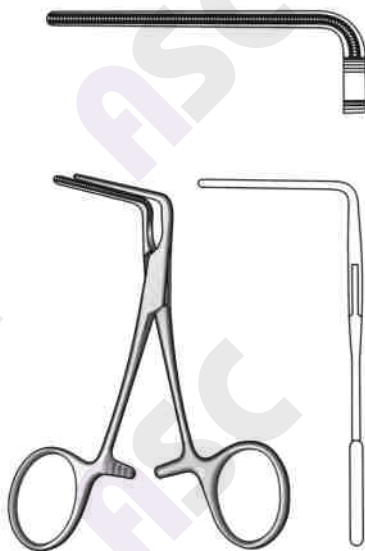

De Bakey
24-3405-10
10 cm / 4"

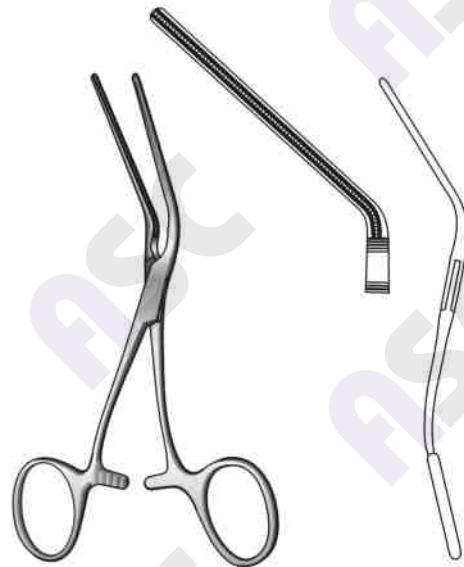

De Bakey
24-3415-13
13 cm / 5 1/4"

Atrauma Cardiovascular Forceps
Atrauma Cardiovascular klemmen
Atrauma Pinzas-clamps cardiovasculares



De Bakay
24-3420-17
17 cm / 6 1/2"

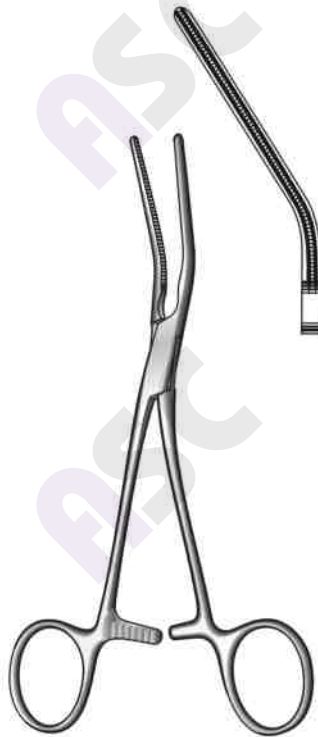

De Bakay
24-3425-16
16 cm / 6 1/4"



De Bakay
24-3430-15
15 cm / 6"

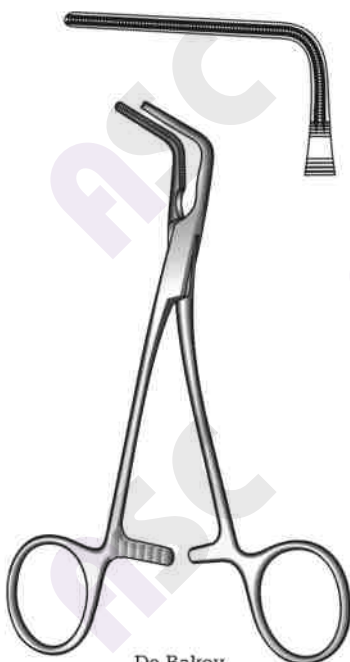

De Bakay
24-3435-15
15 cm / 6"



De Bakay
24-3440-17
17 cm / 6 3/4"

Atrauma Cardiovascular Forceps
Atrauma Cardiovascularklemmen
Atrauma pinzas-clamps cardiovasculares

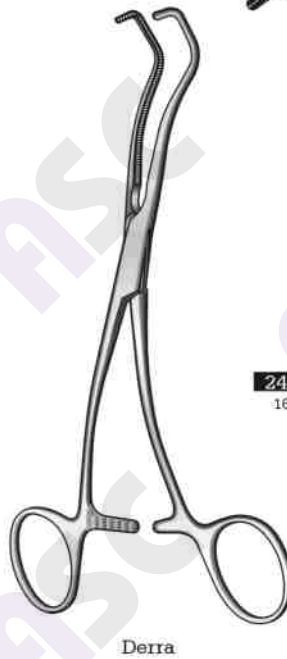
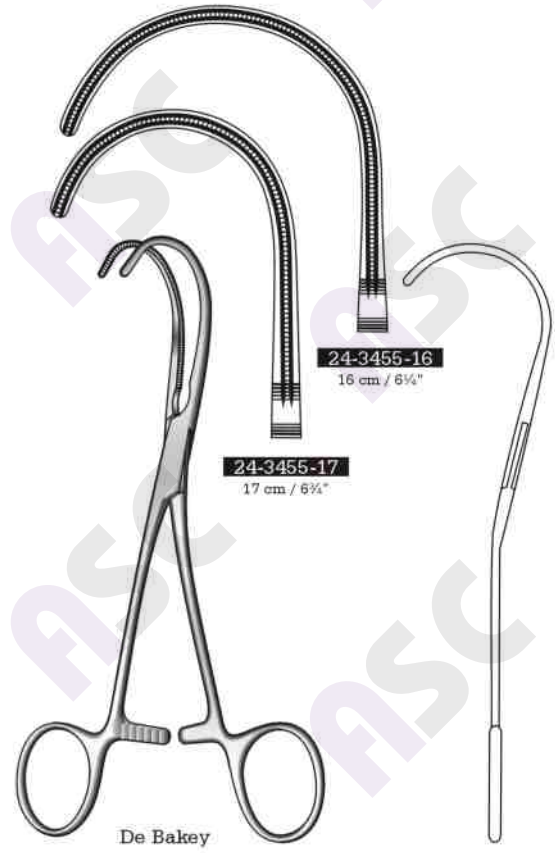
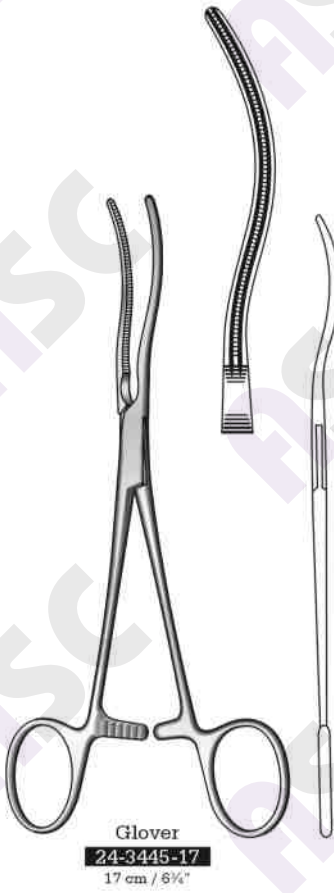

Atrauma Cardiovascular Forceps
Atrauma Cardioaskularklemmen
Atrauma Pinzas- Clamps Cardiovasculares

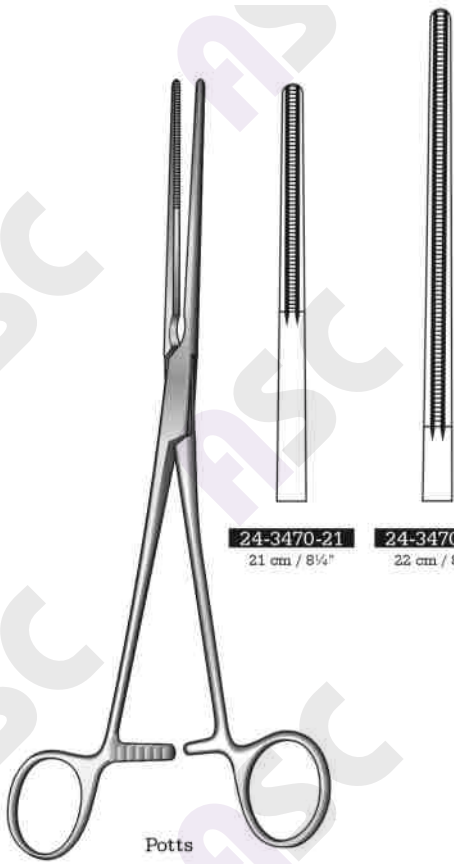

24-3470-21
21 cm / 8¼"

24-3470-22
22 cm / 8¼"

Potts



24-3475-21
21 cm / 8¼"

24-3475-22
22 cm / 8¼"

Potts

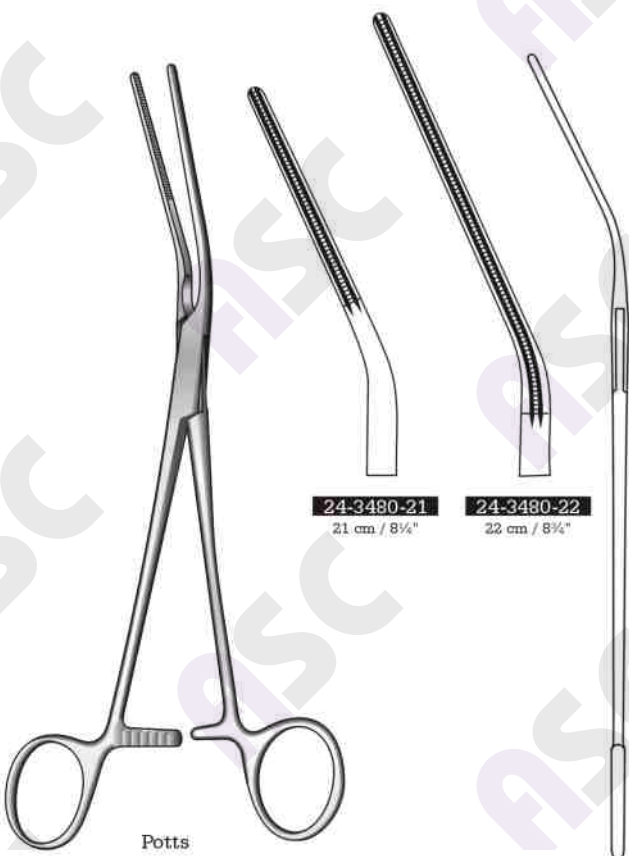

24-3480-21
21 cm / 8¼"

24-3480-22
22 cm / 8¼"

Potts

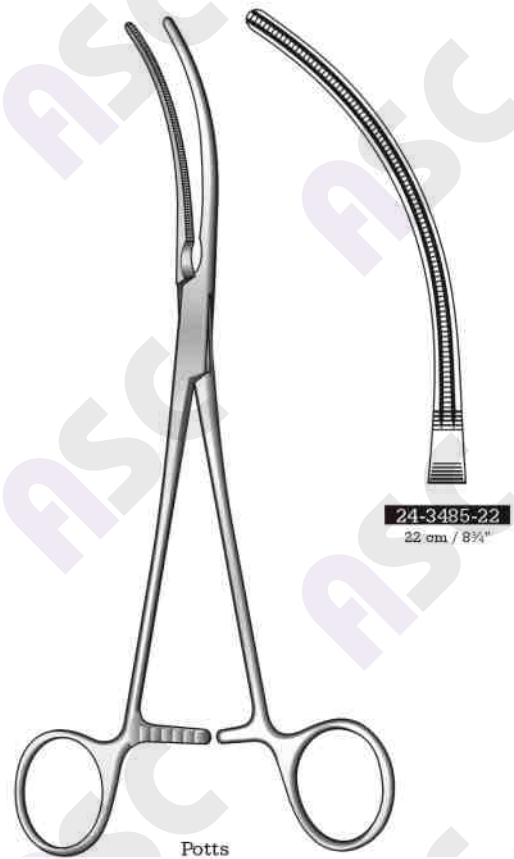

24-3485-22
22 cm / 8¼"

Potts

Atrauma Cardiovascular Forceps
Atrauma Cardiovaskularklemmen
Atrauma pinzas-clamps cardiovasculares

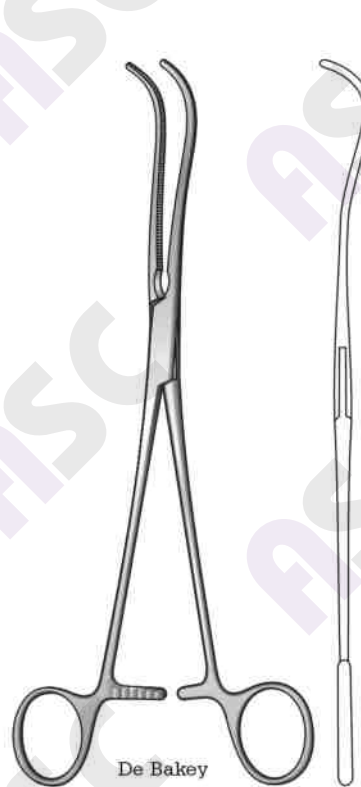
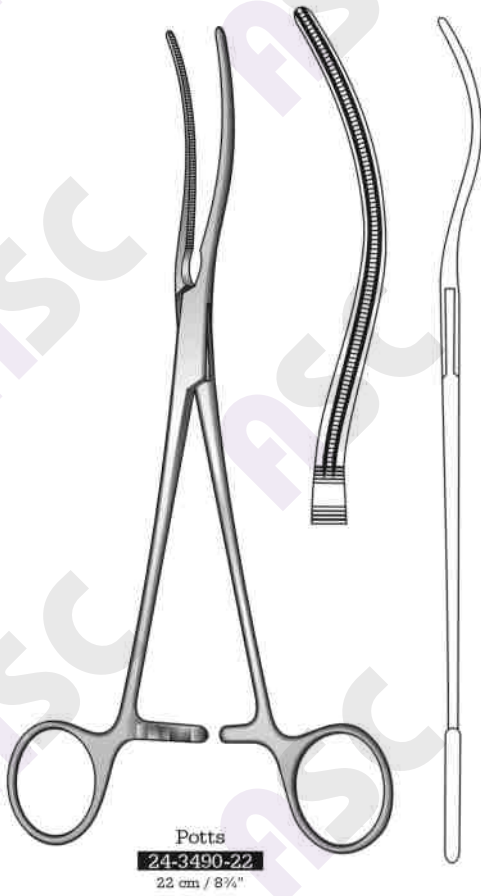

Atrauma Cardiovascular Forceps
Atrauma Cardioaskularklemmen
Atrauma pinzas-clamps cardiovasculares



24-3510-21
21.5 cm / 8½"

24-3510-23
23 cm / 9"

24-3510-27
27 cm / 10½"

24-3510-31
31.5 cm / 12½"



24-3515-21
21.5 cm / 8½"

24-3515-23
23 cm / 9"

24-3515-27
27 cm / 10½"

24-3515-31
31.5 cm / 12½"

Atrauma Cardiovascular Forceps
Atrauma Cardiovaskularklemmen
Atrauma pinzas-clamps cardiovasculares

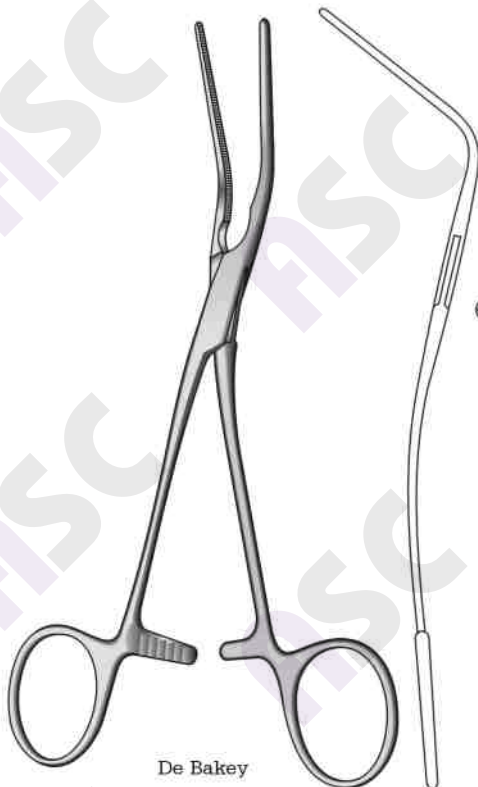
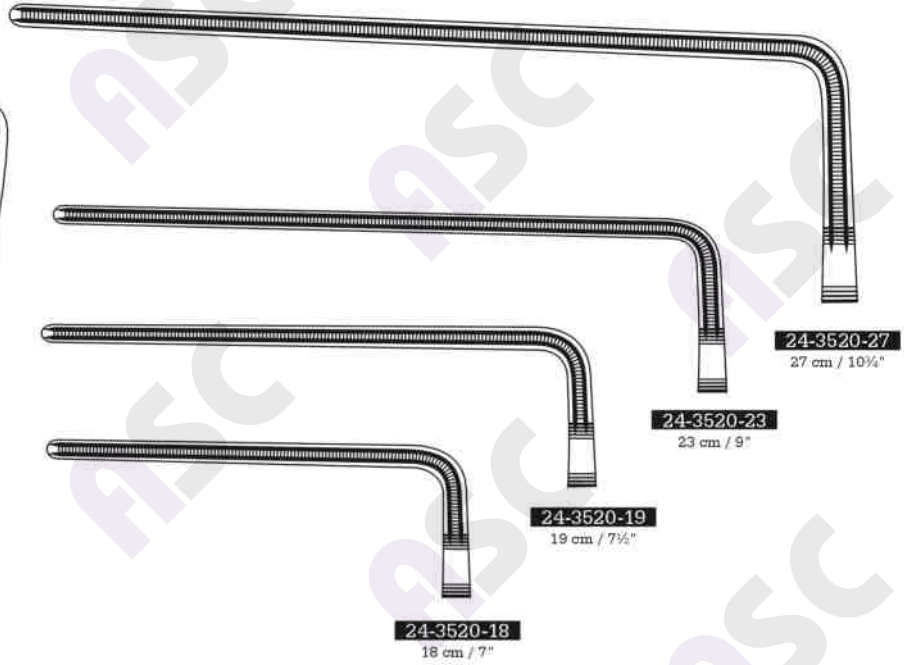
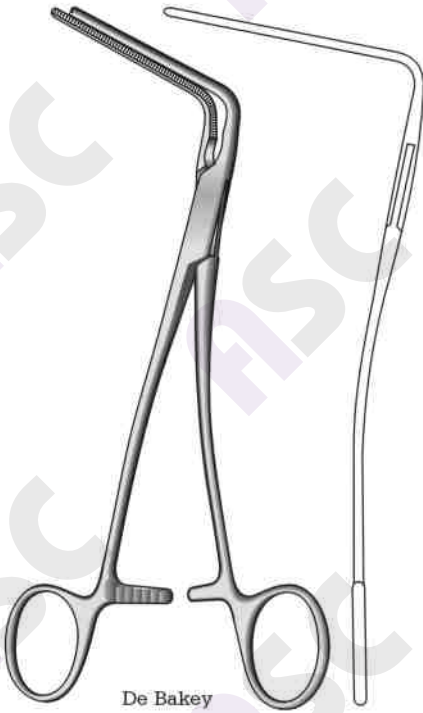

Atrauma Cardiovascular Forceps
Atrauma Cardioaskularklemmen
Atrauma pinzas-clamps cardiovasculares



Atrauma Cardiovascular Forceps
Atrauma Cardiovaskularklemmen
Atrauma pinzas-clamps cardiovasculares



De Bakey



24-3540-26
26 cm / 10 $\frac{1}{4}$ "



24-3540-27
27 cm / 10 $\frac{1}{2}$ "

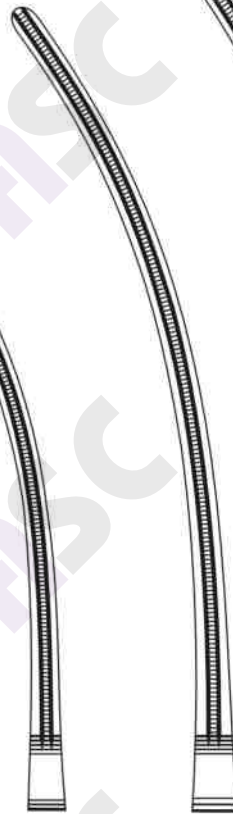

24-3540-31
31 cm / 12 $\frac{1}{4}$ "

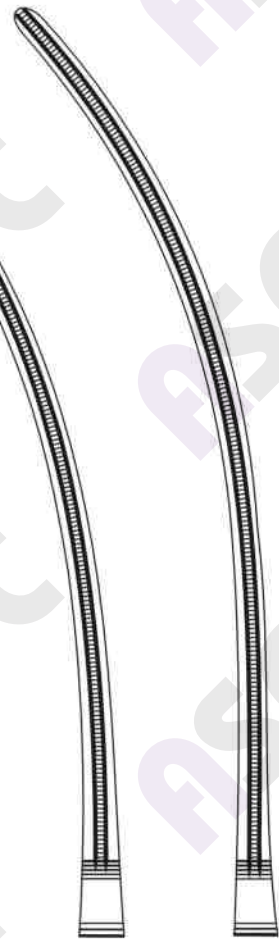

24-3540-33
33 cm / 13"

Atrauma Cardiovascular Forceps
Atrauma Cardioaskularklemmen
Atrauma pinzas-clamps cardiovasculares

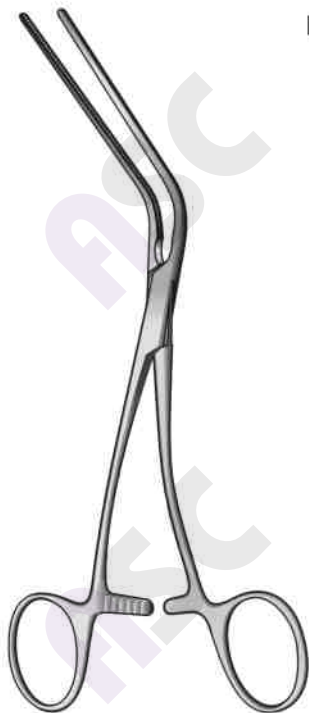

Leland-Jones

Atrauma Cardiovascular Forceps
Atrauma Cardiovaskularklemmen
Atrauma pinzas-clamps cardiovasculares

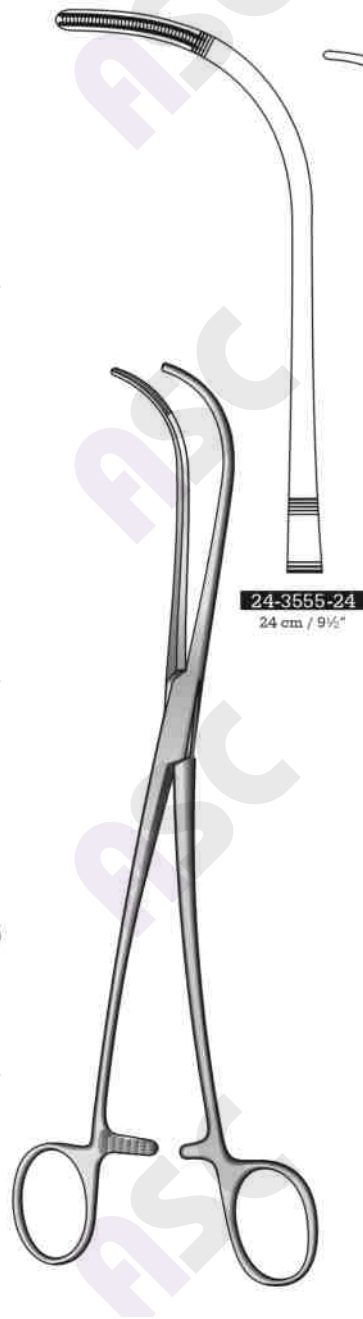

Atrauma Cardiovascular Forceps
Atrauma Cardioaskularklemmen
Atrauma pinzas-clamps cardiovasculares

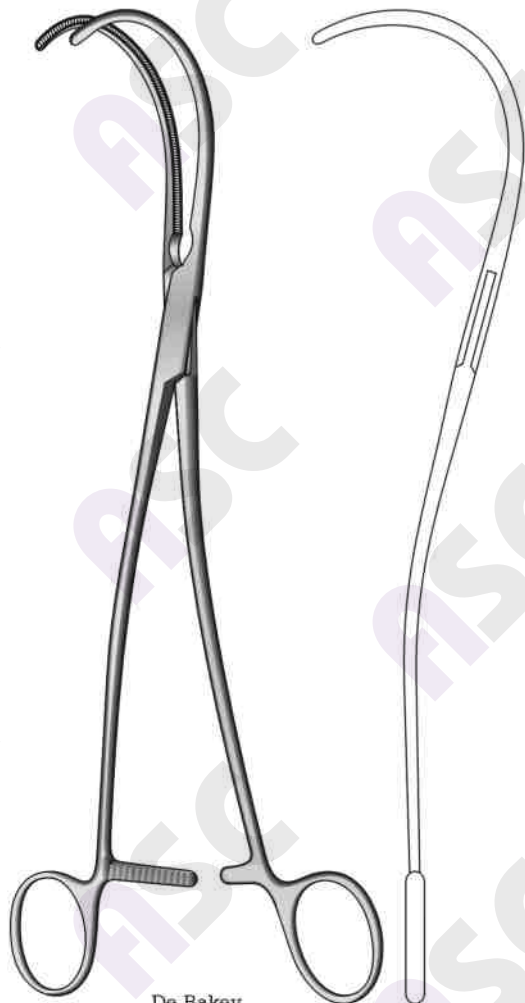
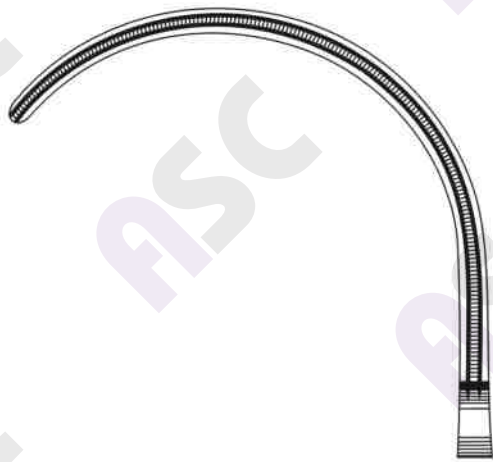

De Bakay
24-3565-25
25 cm / 10"



De Bakay
24-3570-25
25 cm / 10"

Tangential Occlusion Clamps
Tangentialklemmen
Pinzas para oclusión tangencial

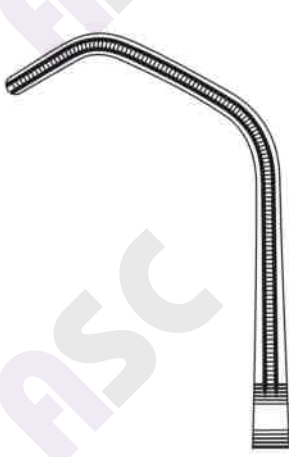

24-3575-20
20.5 cm / 8"

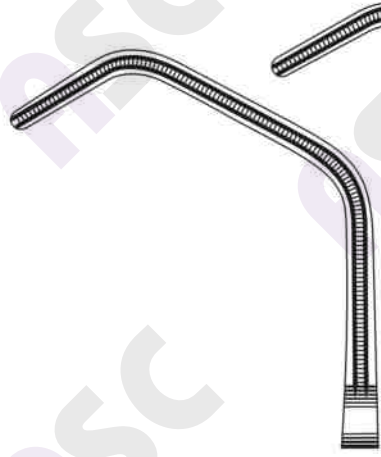

24-3575-24
24 cm / 9½"

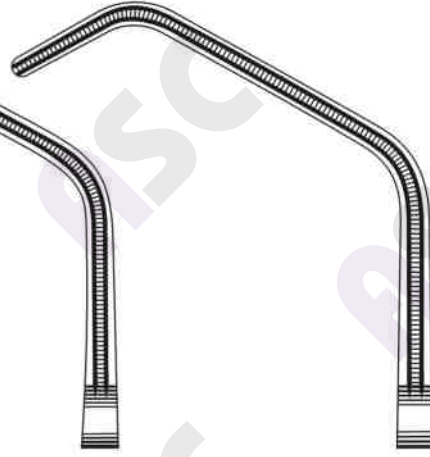

24-3575-25
25 cm / 10"

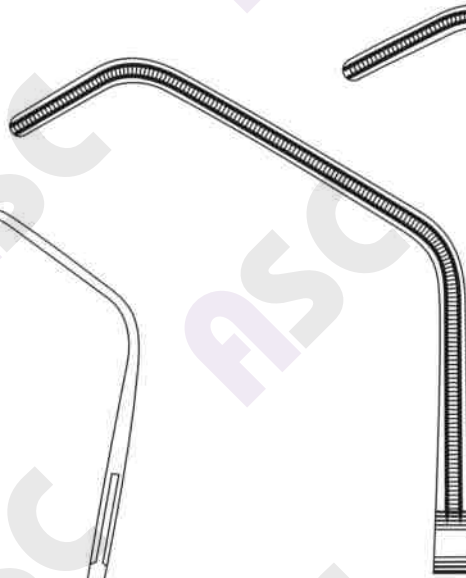

24-3575-26
26.5 cm / 10½"

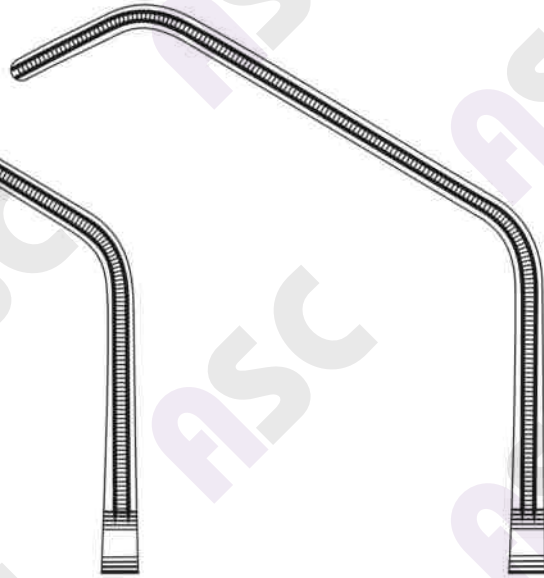

24-3575-27
27.5 cm / 11"

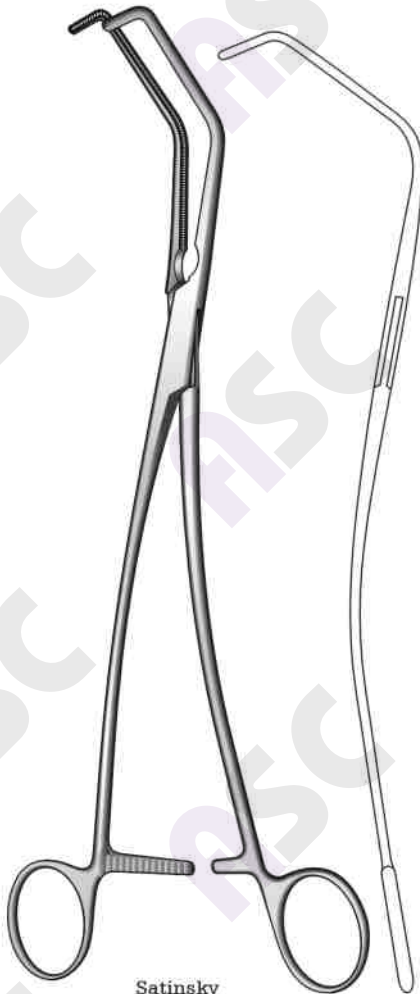

Satinsky

Auricle Clamps
Aurikelklemmen
Pinzas para auricula

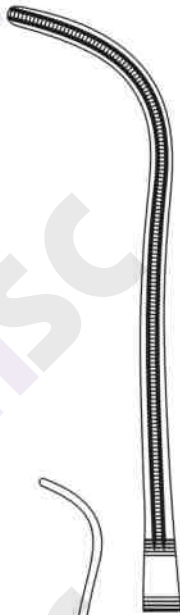

24-3580-24



24-3581-24

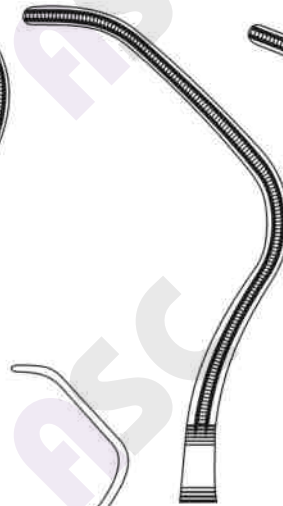

24-3582-24

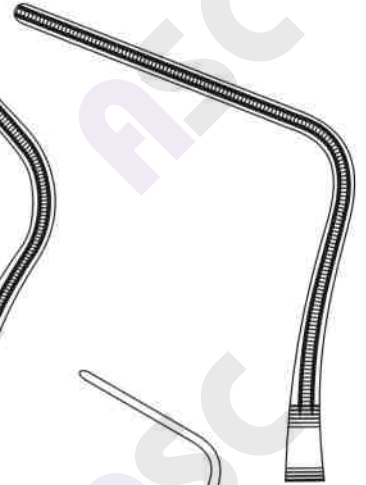

24-3583-24



Harken
24 cm / 9½"

Bronchus Clamps
Bronchusklemmen
Pinzas bronquiales



Anastomosis Clamps, Aortic Clamps
Anastomosenklemmen, Aortaklemmen
Pinzas para anastomosis, Pinzas aorticas



Lambert - Kay

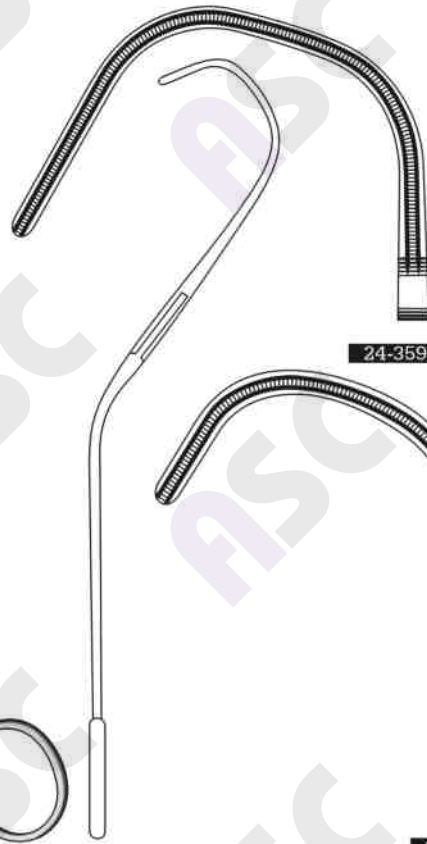

24-3596-00



24-3595-00

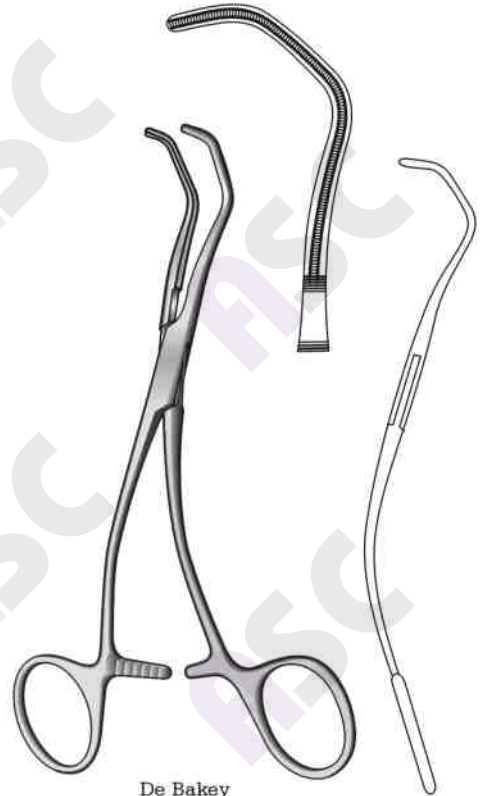

De Bakey

24-3601-17

17 cm / 6 3/4"

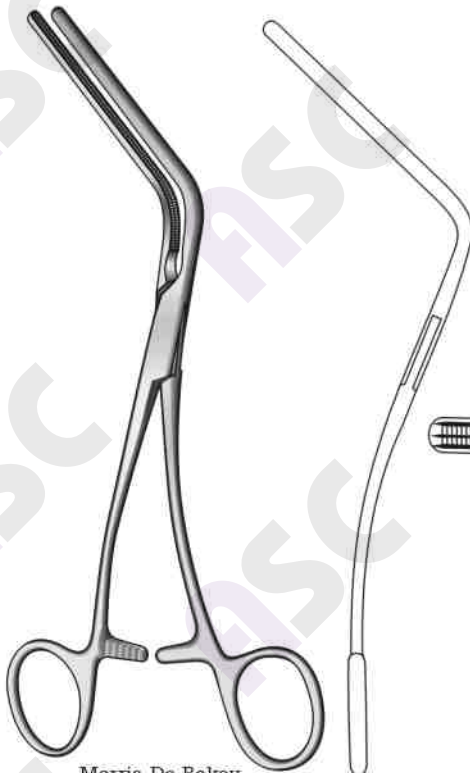

Morris-De Bakey

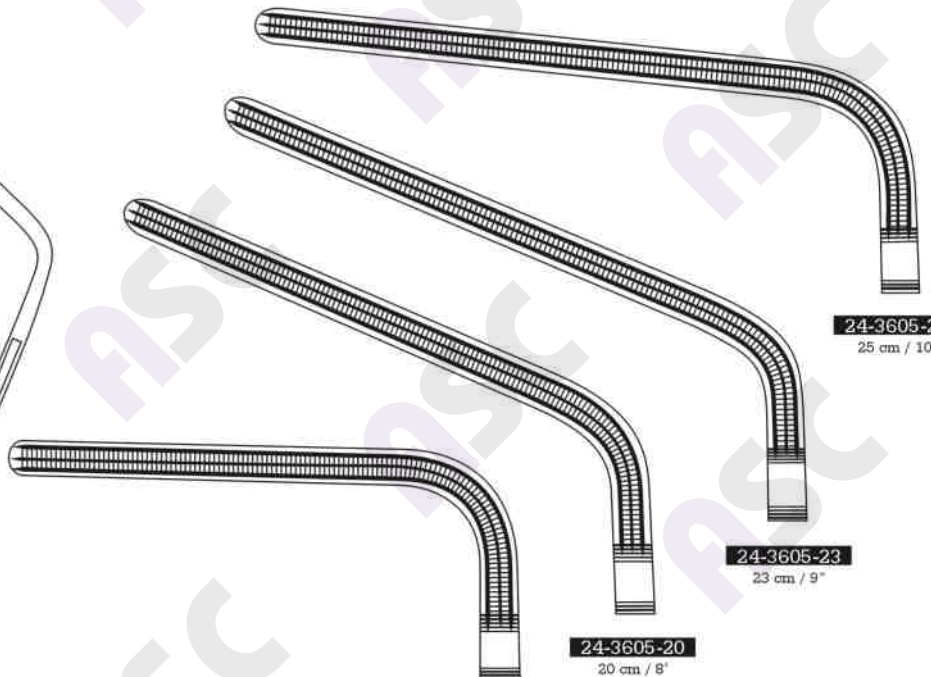

24-3605-18

18 cm / 7"

24-3605-20

20 cm / 8"

24-3605-23

23 cm / 9"

24-3605-25

25 cm / 10"

Aneurysm Clamps
Aneurysmaklemmen
Pinzas para aneurisma



De Bakey-Bahnson

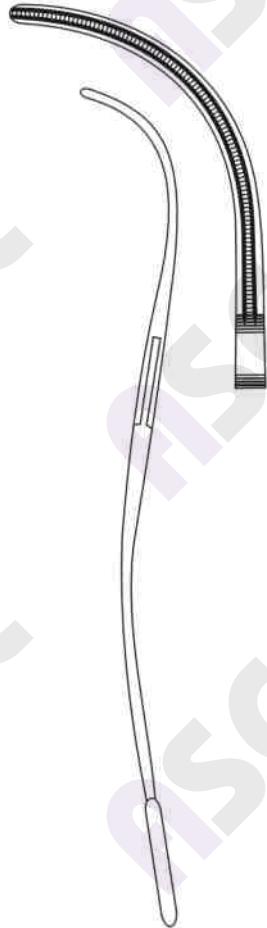

24-3610-23
23 cm / 9"

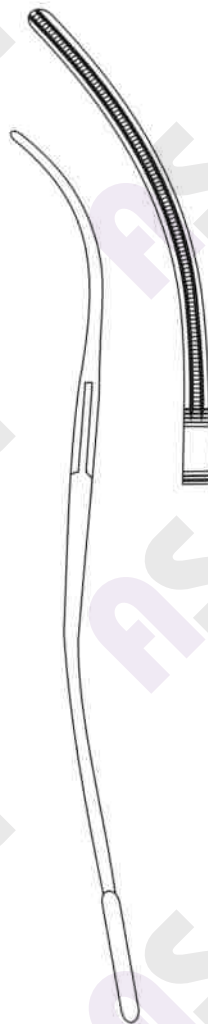

24-3610-24
24 cm / 9½"

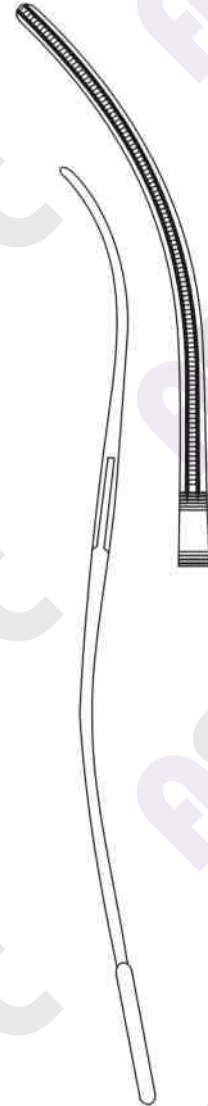

24-3610-25
25 cm / 10"

Neonatal and Pediatric Vascular Clamps, Very Delicate Patterns
 Neonatal- und Kindergefäßklemmen, Extrafeine Modelle
 Pinzas-clamps vasculares para recién nacidos y pediátricos, Modelos muy delicados

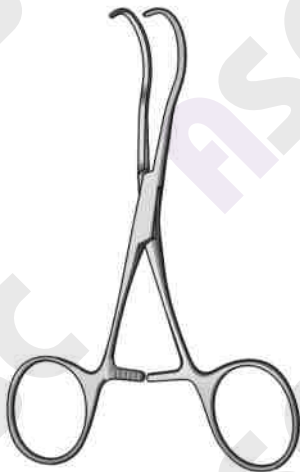

Castaneda

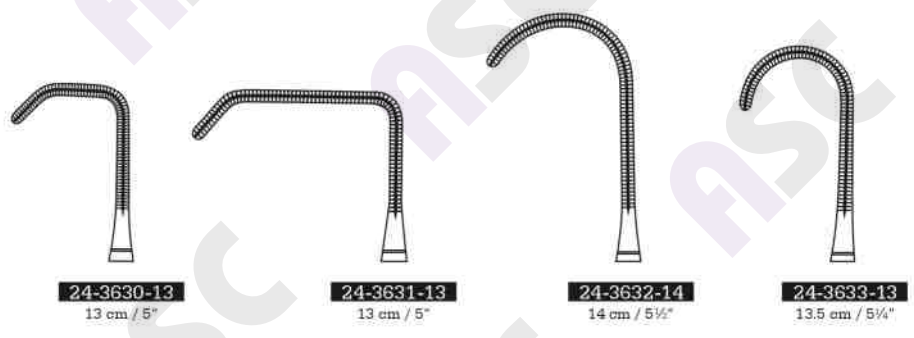
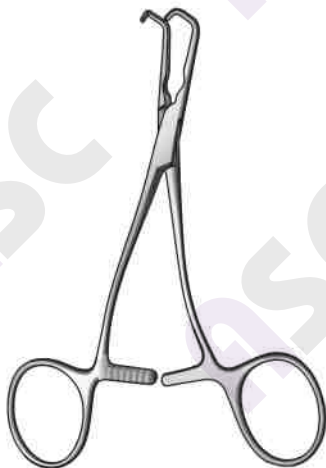

Pediatric Vascular Clamps
Kindergefäßklemmen
Pinzas vasculares pediátricas



24-3635-14
14 cm / 5½"

Cooley



24-3636-14
14 cm / 5½"

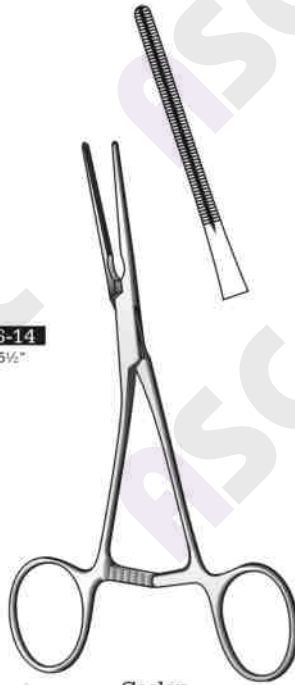

24-3640-14
14 cm / 5½"



24-3645-14
14 cm / 5½"

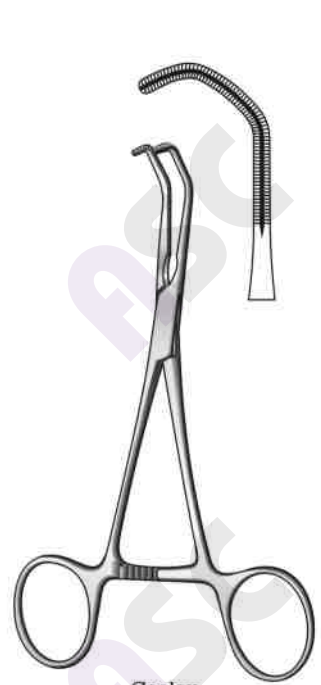

24-3650-14
14 cm / 5½"

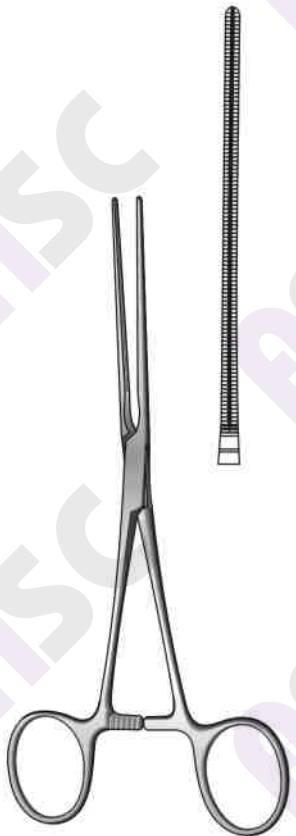

24-3655-16
16.5 cm / 6½"

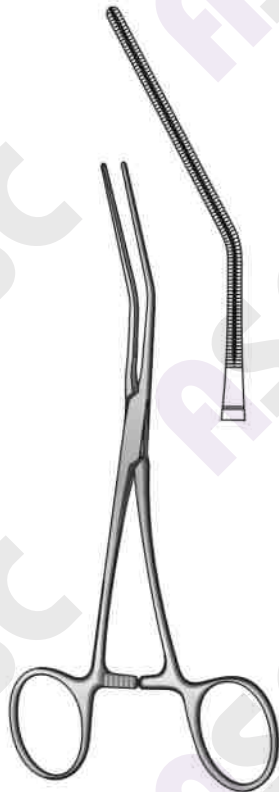

24-3660-16
16 cm / 6¼"



24-3665-15
15 cm / 6"

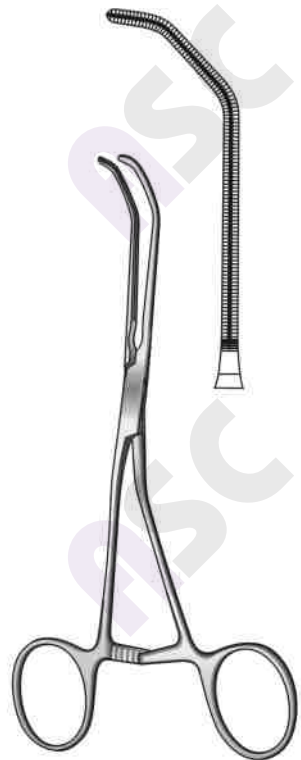

24-3670-15
15.5 cm / 6"

Anastomosis Clamps
Anastomosenklemmen
Pinzas para anastomosis

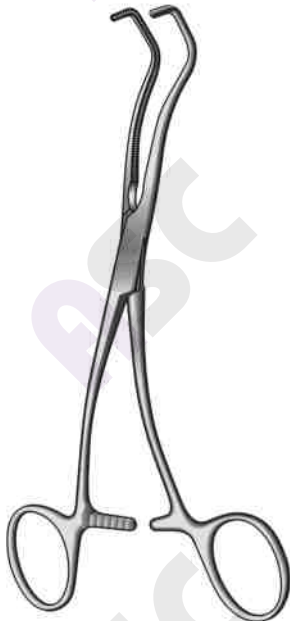

Cooley-Derra

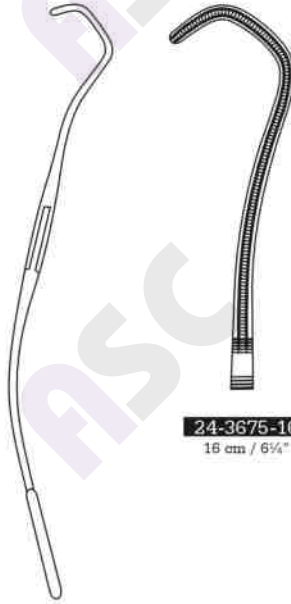

24-3675-16
16 cm / 6 3/4"



24-3675-17
17 cm / 6 3/4"



24-3675-18
18 cm / 7"



Beck
24-3680-17
17 cm / 6 3/4"

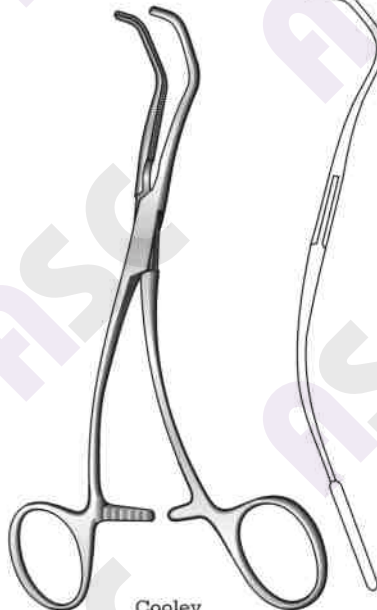
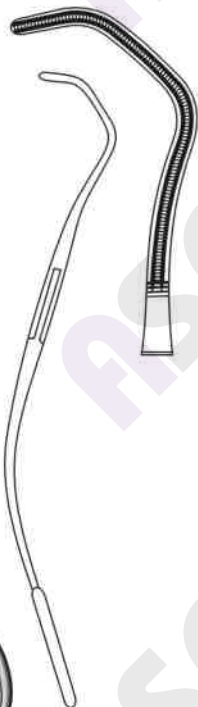

Cooley
24-3685-16
16 cm / 6 3/4"

Atrauma Cardiovascular Forceps
Atrauma Kardiovaskularklemmen
Atrauma pinzas-clamps cardiovasculares

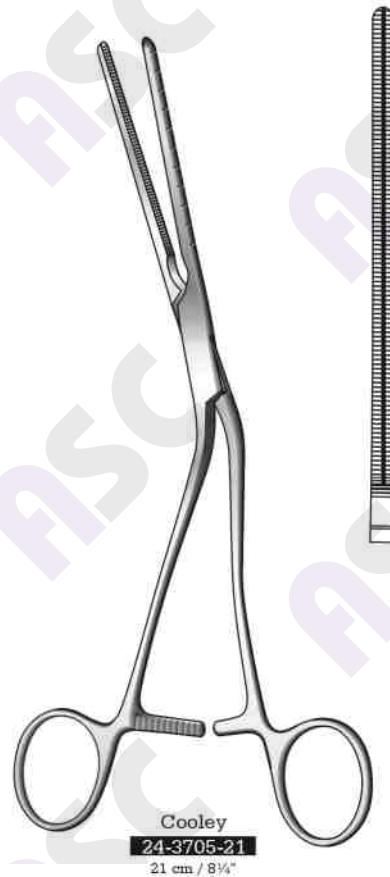
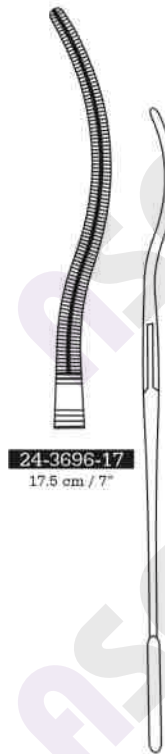
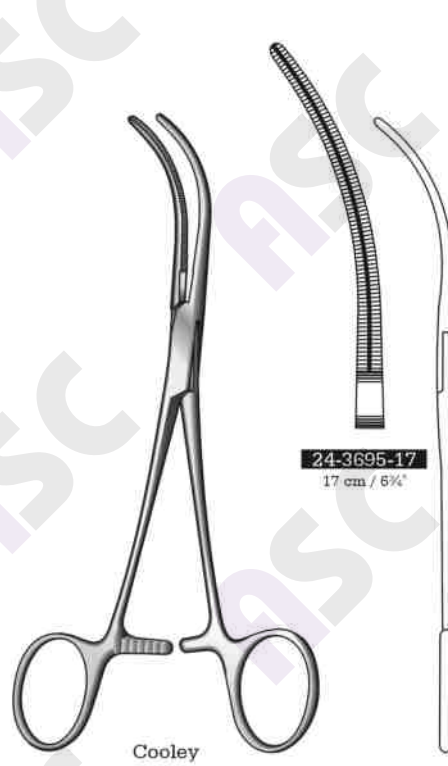

Atrauma Cardiovascular Forceps
Atrauma Kardiovaskularklemmen
Atrauma pinzas-clamps cardiovasculares

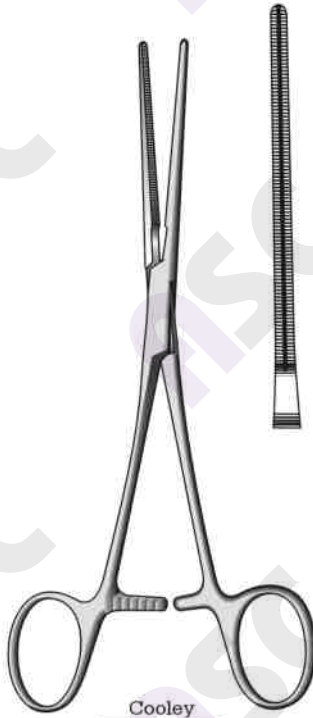

Cooley
24-3710-17
17 cm / 6 3/4"

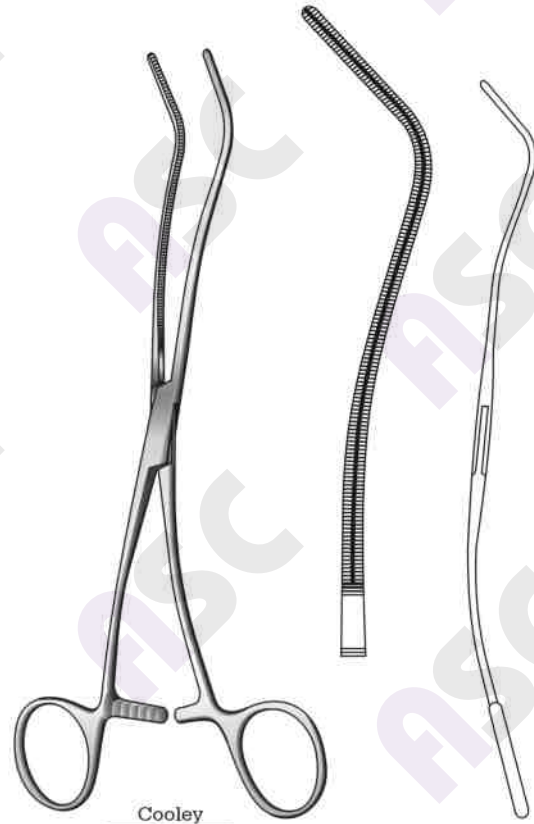

Cooley
24-3715-20
20 cm / 8"

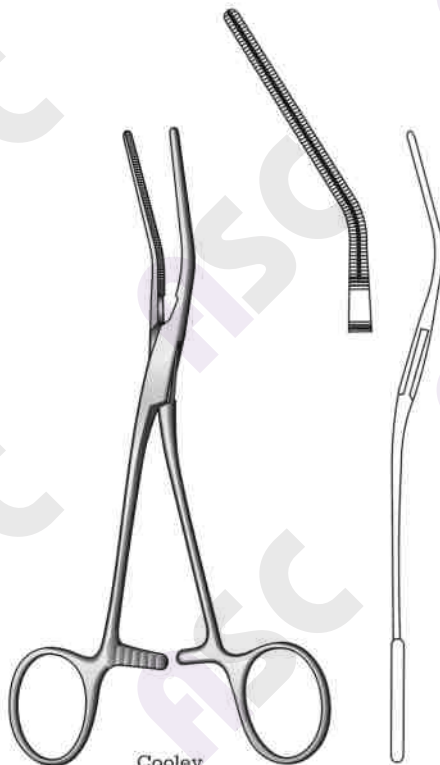

Cooley
24-3720-17
17 cm / 6 3/4"



Cooley
24-3725-15
15 cm / 6"

Anastomosis Clamps, Multi Purpose Vascular Clamps
Anastomosenklemmen, Mehrzweckgefäßklemmen
Pinzas para anastomosis, Pinzas vasculares de usos multiples



Cooley
24-3730-15
15 cm / 6"

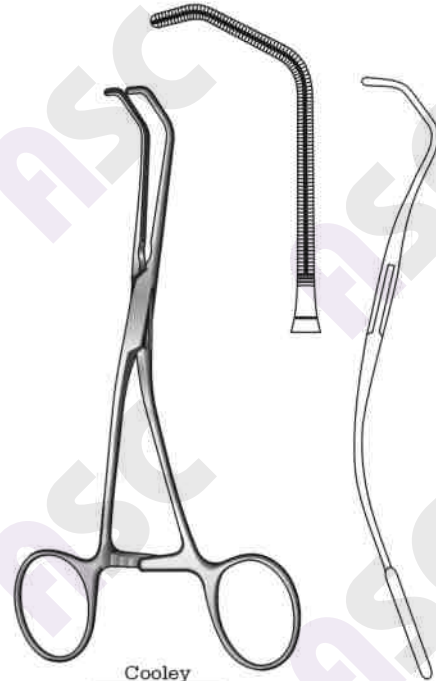

Cooley
24-3735-15
15 cm / 6"

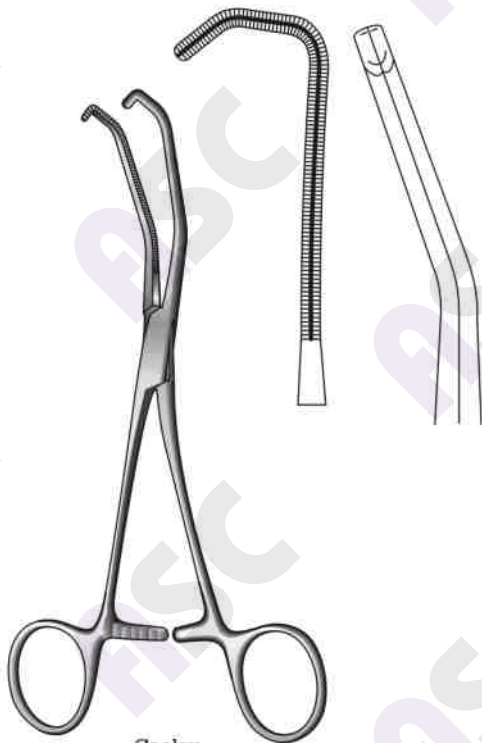

Cooley
24-3740-17
17 cm / 6 3/4"

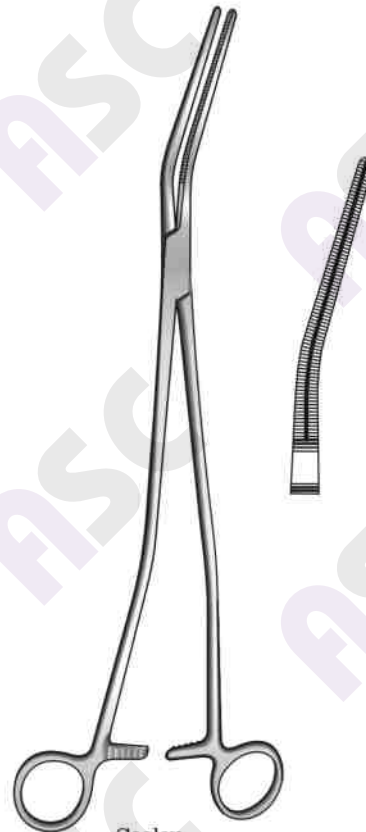

Cooley
24-3745-30
30 cm / 12"
7 mm jaws length

Carotid Shunt Clamps, Peripheral Vascular Clamps
Carotis-Shuntklemmen, Peripheral-Gefäßklemmen
Pinzas para shunt carotido, Pinzas para vasos perifericos

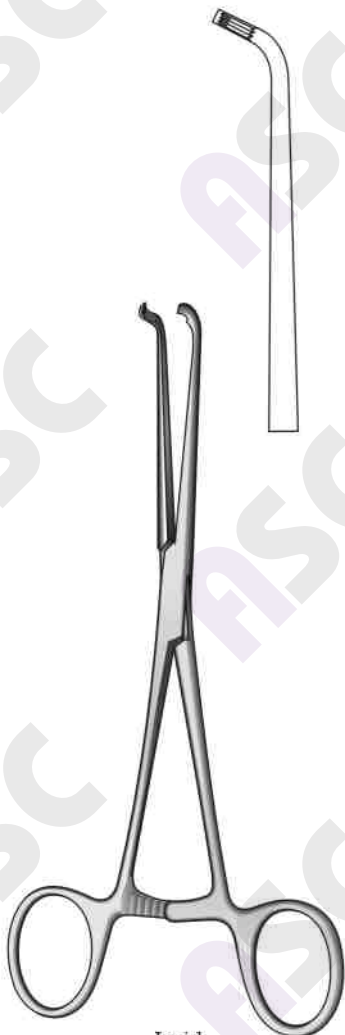

Javid
24-3750-18
18 cm / 7"

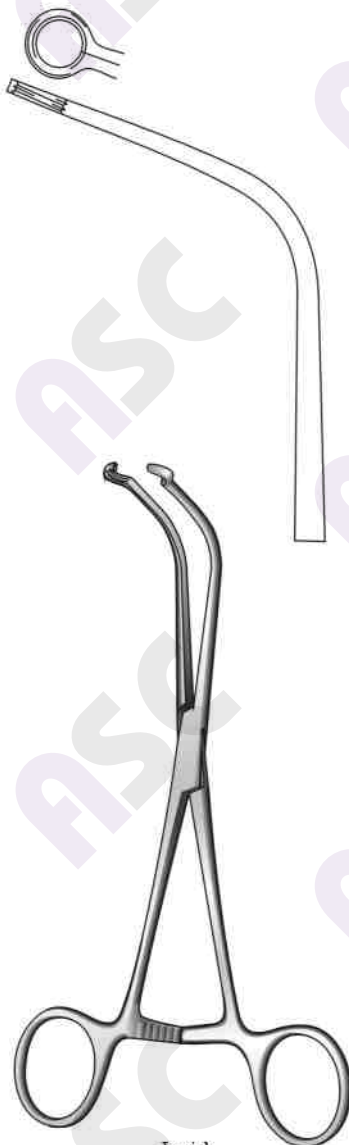

Javid
24-3755-19
19 cm / 7 1/2"

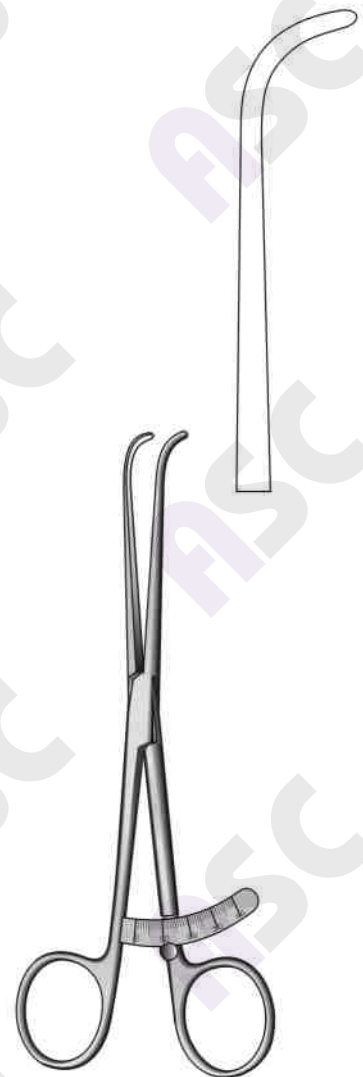

24-3760-18
18 cm / 7"
Vascular measuring device

Vascular Dilators, Intima Spatula, Vascular Dissectors
Gefäßdilatoren, Intimspatel, Gefäßdissektoren
Dilatadores vasculares, Espátulas para la intima, Disecadores vasculares

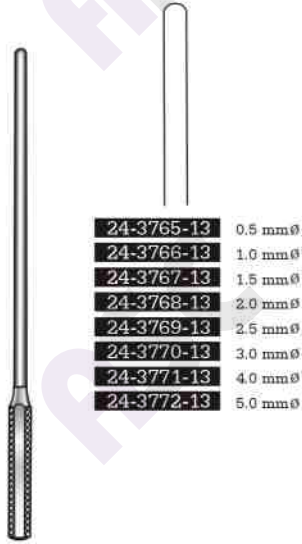

Cooley
13 cm / 5¼"
Malleable

24-3765-13	0.5 mm Ø
24-3766-13	1.0 mm Ø
24-3767-13	1.5 mm Ø
24-3768-13	2.0 mm Ø
24-3769-13	2.5 mm Ø
24-3770-13	3.0 mm Ø
24-3771-13	4.0 mm Ø
24-3772-13	5.0 mm Ø



De Bakey
Malleable

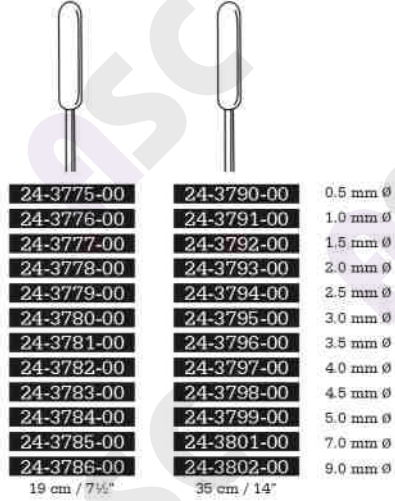

24-3775-00	24-3790-00	0.5 mm Ø
24-3776-00	24-3791-00	1.0 mm Ø
24-3777-00	24-3792-00	1.5 mm Ø
24-3778-00	24-3793-00	2.0 mm Ø
24-3779-00	24-3794-00	2.5 mm Ø
24-3780-00	24-3795-00	3.0 mm Ø
24-3781-00	24-3796-00	3.5 mm Ø
24-3782-00	24-3797-00	4.0 mm Ø
24-3783-00	24-3798-00	4.5 mm Ø
24-3784-00	24-3799-00	5.0 mm Ø
24-3785-00	24-3801-00	7.0 mm Ø
24-3786-00	24-3802-00	9.0 mm Ø

19 cm / 7½" 35 cm / 14"



3 mm
Blunt

24-3805-18	18.5 cm / 7½"
24-3805-21	21.5 cm / 8¼"



Blunt

24-3810-14	14 cm / 5½"
24-3810-23	23 cm / 9"

Vascular Dilators, Intima Spatula, Vascular Dissectors
Gefäßdilatoren, Intimspatel, Gefäßdissektoren
Dilatadores vasculares, Espátulas para la intima, Disecadores vasculares



Robb
24-3815-24
24 cm / 9½"
Fig. 1



Robb
24-3820-24
24 cm / 9½"
Fig. 2



Robb
24-3825-24
24 cm / 9½"
Fig. 3

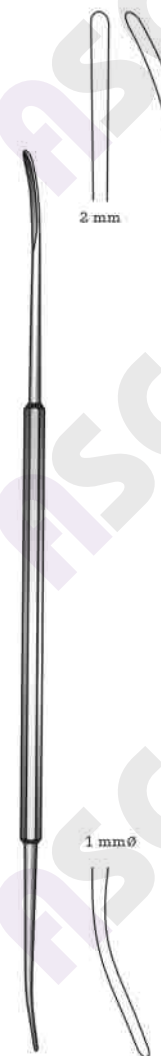

Robb
24-3830-24
24 cm / 9½"
Fig. 4

Aortic Dilators
Aorta Dilatatore
Dilatadores aórticos

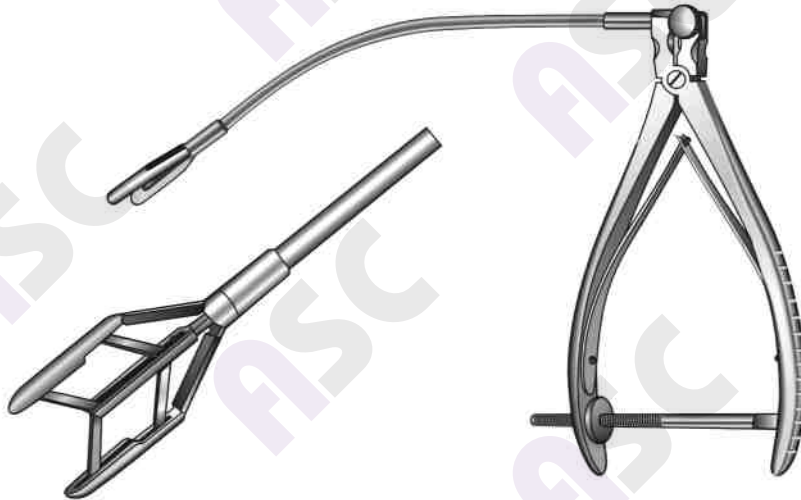

Cooley
24-3835-00
Blade opening from 8-15 mm
With thread fixation



Tubbs
24-3840-00
Blade opening from 8-42 mm
With fixation screw



Alphabetical Index



Alphabetical Index

ABLAZA-MORSE Rib Contractors	16
ALLISON Rib Contractors, Spatulas	17
Anastomosis Clamps	42, 46, 49
Aneurysm Clamps	43
Aorta Clamps	22, 42
Aortic Dilators	53
Atrauma Bulldog Clamps	25
Atrauma Cardiovascular Forceps	26-28, 30-38, 48
Atrauma Haemostatic Forceps	25, 26
Atrauma Tissue Forceps	23
Auricle Clamps	40
BABY-BAILEY Rib Contractors	16
BABY-FINOCCHIETTO Rib Spreaders	6
BABY-SATINSKY Blood Vessel Clamps	20
BAHNSON-De BAKEY Aneurysm Clamps	43
BAILEY Rib Contractors	16
BAILEY-BABY Rib Contractors	16
BAILEY-GIBBON Rib Contractors	16
BAINBRIDGE Atrauma Cardiovascular Forceps	26
BECK Anastomosis Clamps	46
BECK-De BAKEY Atrauma Cardiovascular Forceps	29
BETHUNE Bone and Rib Shears	3
BLALOCK Aorta Clamps	22
Blood Vessel Clamps	18, 20-21
Bone Shears	1-4
BRITSCH-SAUERBRUCH Rib Shears	4
Bronchus Clamps	19, 41
BRUNNER Rib Shears	4
Bulldog Clamps	24, 25
BURFORD Rib Spreaders	9
Cardiovascular Forceps	26
Cardiovascular Forceps, Atrauma	26-28, 30-38, 48
Carotid Shunt Clamps	50
CASTANEDA Rib Spreaders	11
CASTANEDA Vascular Clamps	44
Clamps, Anastomosis	42, 46, 49
Clamps, Aneurysm	43
Clamps, Aorta	22
Clamps, Aortic	42
Clamps, Atrauma Bulldog	25
Clamps, Auricle	40
Clamps, Blood Vessel	20, 21
Clamps, Bronchus	19, 41
Clamps, Bulldog	24
Clamps, Carotid Shunt	50
Clamps, Multi Purpose Vascular	49
Clamps, Pediatric Vascular	44, 45
Clamps, Peripheral Vascular	50
Clamps, Tangential Occlusion	39
Clamps, Vascular	44, 45, 50
Clamps, Vessel	20, 21
COLLIN-CORYLLOS BETHUNE Bone & Rib Shears	2
COOLEY Anastomosis Clamps	46, 49
COOLEY Aortic Dilators	53
COOLEY Atrauma Cardiovascular Forceps	47, 48
COOLEY Pediatric Vascular Clamps	45
COOLEY Rib Contractors, Spatulas	17
COOLEY Rib Spreaders	8
COOLEY Vascular Dilators	51
COOLEY Vascular Forceps	24
COOLEY-DERRA Anastomosis Clamps	46
CORYLLOS BETHUNE-COLLIN Bone & Rib Shears	2
CORYLLOS Bone & Rib Shears	3
CRILE-De BAKEY Atrauma Haemostatic Forceps	25
De BAKEY Anastomosis Clamps	42
De BAKEY Atrauma Bulldog Clamps	25
De BAKEY Atrauma Cardio Forceps	27, 29, 31, 33-35, 37, 38
De BAKEY Atrauma Tissue Forceps	23
De BAKEY Intima Spatula	51
De BAKEY Rib Retractors	13, 14
De BAKEY Vascular Forceps	24
De BAKEY-BAHNSON Aneurysm Clamps	43

De BAKEY-BECK Atrauma Cardiovascular Forceps	29
De BAKEY-CRILE Atrauma Haemostatic Forceps	25
De BAKEY-MORRIS Aortic Clamps	42
De BAKEY-MOSQUITO Atrauma Haemostatic Forceps	25
De BAKEY-PEAN Atrauma Haemostatic Forceps	26
De BAKEY-RANKIN Atrauma Haemostatic Forceps	25
DERRA Atrauma Cardiovascular Forceps	29
DERRA-COOLEY Anastomosis Clamps	46
Dilators, Aortic	53
Dilators, Vascular	51, 52
Dissectors, Vascular	51, 52
DOYEN Bone & Rib Shears	3
FAVALORO-MORSE Retractors	12
FINOCCHIETTO Rib Spreaders	10
FINOCCHIETTO (Modif.) Rib & Sternal Retractors	12
FINOCCHIETTO Rib Spreaders	6, 7
FINOCCHIETTO-BABY Rib Spreaders	6
Forceps, Atrauma Cardiovascular	26-28, 30-38, 47, 48
Forceps, Atrauma Haemostatic	25, 26
Forceps, Atrauma Tissue	23
Forceps, Lung Grasping	18
Forceps, Vascular	24
GIBBON-BAILEY Rib Contractors	16
GIERTZ-STILLE Rib Shears	4
GLOVER Atrauma Cardiovascular Forceps	29
GLUCK Bone & Rib Shears	1
Grasping Forceps	18
Haemostatic Forceps	25, 26
HAIGHT Rib Spreaders	5
HARKEN Auricle Clamps	40
HARKEN Blood Vessel Clamps	21
HERTZIER Rib Rib Spreader	17
Intima Spatula	51, 52
DAVID Carotid Shunt Clamps	50
JOHNS HOPKINS Aorta Clamps	22
JOHNS HOPKINS Blood Vessel Clamps	18
JONES-LELAND Atrauma Cardiovascular Forceps	36
KAY-LAMBERT Anastomosis Clamps	42
LAMBERT-KAY Anastomosis Clamps	42
LEES Bronchus Clamps	41
LELAND-JONES Atrauma Cardiovascular Forceps	36
LEMMON Rib Contractors	16
LOVELACE Lung Grasping Forceps	18
Lung Grasping Forceps	18
MORRIS Rib Contractors	17
MORRIS-De BAKEY Aortic Clamps	42
MORSE Retractors	12
MORSE-ABLAZA Rib Contractors	16
MORSE-FAVALORO Retractors	12
MOSQUITO-De BAKEY Atrauma Haemostatic Forceps	25
Multi Purpose Vascular Clamps	49
Neonatal Vascular Clamps	44
Occlusion Clamps, Tangential	39
PEAN-De BAKEY Atrauma Haemostatic Forceps	26
Pediatric Vascular Clamps	44, 45
Peripheral Vascular Clamps	50
POTTS Atrauma Cardiovascular Forceps	30-32
PRICE-THOMAS Bronchus Clamps	19
RANKIN-De BAKEY Atrauma Haemostatic Forceps	25
Retractors	12-15
Retractors, Rib	13, 14
Retractors, Thoracic	15
Rib Contractors	16, 17
Rib Retractors	12-14
Rib Shears	1-4
Rib Spatulas	17
Rib Spreaders	5, 7-11
ROBB Vascular Dissectors	52
ROOS Bone & Rib Shears	2
SAROT Bronchus Clamps	19
SATINSKY Blood Vessel Clamps	20
SATINSKY Tangential Occlusion Clamps	39

A large, light gray, semi-transparent watermark of a stylized 'A' or 'S' shape is centered on the page. The page contains horizontal lines for writing.

Index by Code



Index by Code

Code	Page
24-3001-20	1
24-3001-23	1
24-3005-22	1
24-3010-19	1
24-3015-19	1
24-3015-22	1
24-3020-24	2
24-3020-30	2
24-3021-24	2
24-3021-30	2
24-3025-33	2
24-3030-21	2
24-3035-35	3
24-3036-35	3
24-3040-34	3
24-3045-19	3
24-3050-32	4
24-3055-36	4
24-3060-27	4
24-3065-24	4
24-3065-27	4
24-3068-01	4
24-3068-02	4
24-3070-00	5
24-3075-00	5
24-3076-00	5
24-3080-00	6
24-3085-00	6
24-3086-00	6
24-3087-00	6
24-3088-00	6
24-3090-00	7
24-3091-00	7
24-3092-00	7
24-3095-00	7
24-3095-15	16
24-3098-14	16
24-3098-18	16
24-3101-00	8
24-3105-00	8
24-3106-00	8
24-3110-00	8
24-3115-00	9
24-3120-00	9
24-3121-00	9
24-3122-00	9
24-3125-00	10
24-3130-00	10
24-3131-00	10
24-3132-00	10
24-3133-00	10
24-3135-00	10
24-3140-00	10
24-3141-00	10
24-3142-00	10
24-3145-00	11
24-3150-00	11
24-3155-00	11
24-3160-00	12
24-3165-00	12
24-3170-00	12
24-3175-00	13
24-3176-00	13
24-3177-00	13
24-3178-00	13

Code	Page
24-3179-00	13
24-3180-00	14
24-3181-00	14
24-3182-00	14
24-3183-00	14
24-3184-00	14
24-3185-00	14
24-3190-00	15
24-3191-00	15
24-3192-00	15
24-3193-00	15
24-3200-20	16
24-3203-15	16
24-3205-20	16
24-3208-20	16
24-3210-00	17
24-3215-26	17
24-3220-00	17
24-3221-24	17
24-3222-24	17
24-3223-25	17
24-3225-30	17
24-3225-32	17
24-3230-20	18
24-3235-20	18
24-3240-22	18
24-3241-22	18
24-3245-23	19
24-3246-23	19
24-3247-23	19
24-3248-23	19
24-3250-24	19
24-3251-24	19
24-3255-22	19
24-3260-22	19
24-3261-22	19
24-3265-15	20
24-3270-26	20
24-3271-26	20
24-3275-26	20
24-3276-26	20
24-3280-24	21
24-3285-24	21
24-3286-24	21
24-3287-24	21
24-3290-28	21
24-3295-15	22
24-3295-20	22
24-3295-25	22
24-3301-20	22
24-3302-20	22
24-3303-20	22
24-3305-16	23
24-3305-20	23
24-3305-24	23
24-3305-30	23
24-3310-16	23
24-3310-20	23
24-3310-24	23
24-3315-16	23
24-3315-20	23
24-3315-24	23
24-3315-30	23
24-3320-16	24
24-3320-20	24

Code	Page
24-3320-24	24
24-3320-30	24
24-3325-16	24
24-3325-20	24
24-3325-24	24
24-3325-30	24
24-3330-16	24
24-3330-20	24
24-3335-06	24
24-3335-07	24
24-3335-09	24
24-3335-11	24
24-3340-05	24
24-3340-06	24
24-3340-08	24
24-3340-10	24
24-3345-07	25
24-3345-08	25
24-3345-10	25
24-3345-12	25
24-3350-07	25
24-3350-08	25
24-3350-10	25
24-3350-11	25
24-3355-12	25
24-3355-15	25
24-3356-12	25
24-3356-15	25
24-3360-14	25
24-3361-14	25
24-3365-16	25
24-3366-16	25
24-3370-16	26
24-3370-18	26
24-3370-20	26
24-3370-26	26
24-3370-28	26
24-3371-16	26
24-3371-18	26
24-3371-20	26
24-3371-26	26
24-3371-28	26
24-3375-16	26
24-3375-18	26
24-3375-20	26
24-3375-26	26
24-3375-28	26
24-3380-15	26
24-3380-18	26
24-3385-15	26
24-3385-18	26
24-3390-12	27
24-3395-11	27
24-3401-12	27
24-3405-10	27
24-3415-13	27
24-3420-17	28
24-3425-16	28
24-3430-15	28
24-3435-15	28
24-3440-17	28
24-3445-17	29
24-3450-17	29
24-3455-16	29
24-3455-17	29

Code	Page
24-3460-17	29
24-3465-16	29
24-3465-17	29
24-3465-18	29
24-3470-21	30
24-3470-22	30
24-3475-21	30
24-3475-22	30
24-3480-21	30
24-3480-22	30
24-3485-22	30
24-3490-22	31
24-3495-19	31
24-3495-23	31
24-3501-16	31
24-3505-19	31
24-3505-20	31
24-3510-21	32
24-3510-23	32
24-3510-27	32
24-3510-31	32
24-3515-21	32
24-3515-23	32
24-3515-27	32
24-3515-31	32
24-3520-18	33
24-3520-19	33
24-3520-23	33
24-3520-27	33
24-3525-20	33
24-3525-21	33
24-3525-25	33
24-3525-29	33
24-3530-28	34
24-3535-30	34
24-3540-26	35
24-3540-27	35
24-3540-31	35
24-3540-33	35
24-3545-18	36
24-3545-19	36
24-3545-20	36
24-3550-20	37
24-3555-24	37
24-3560-24	37
24-3565-25	38
24-3570-25	38
24-3575-20	39
24-3575-24	39
24-3575-25	39
24-3575-26	39
24-3575-27	39
24-3580-24	40
24-3581-24	40
24-3582-24	40
24-3583-24	40
24-3585-23	41
24-3585-25	41
24-3590-25	41
24-3595-00	42
24-3596-00	42
24-3601-17	42
24-3605-18	42
24-3605-20	42
24-3605-23	42

A large area of the page is covered by a light gray background with a faint, large-scale circular pattern. Overlaid on this background are horizontal lines, creating a ruled area for notes.

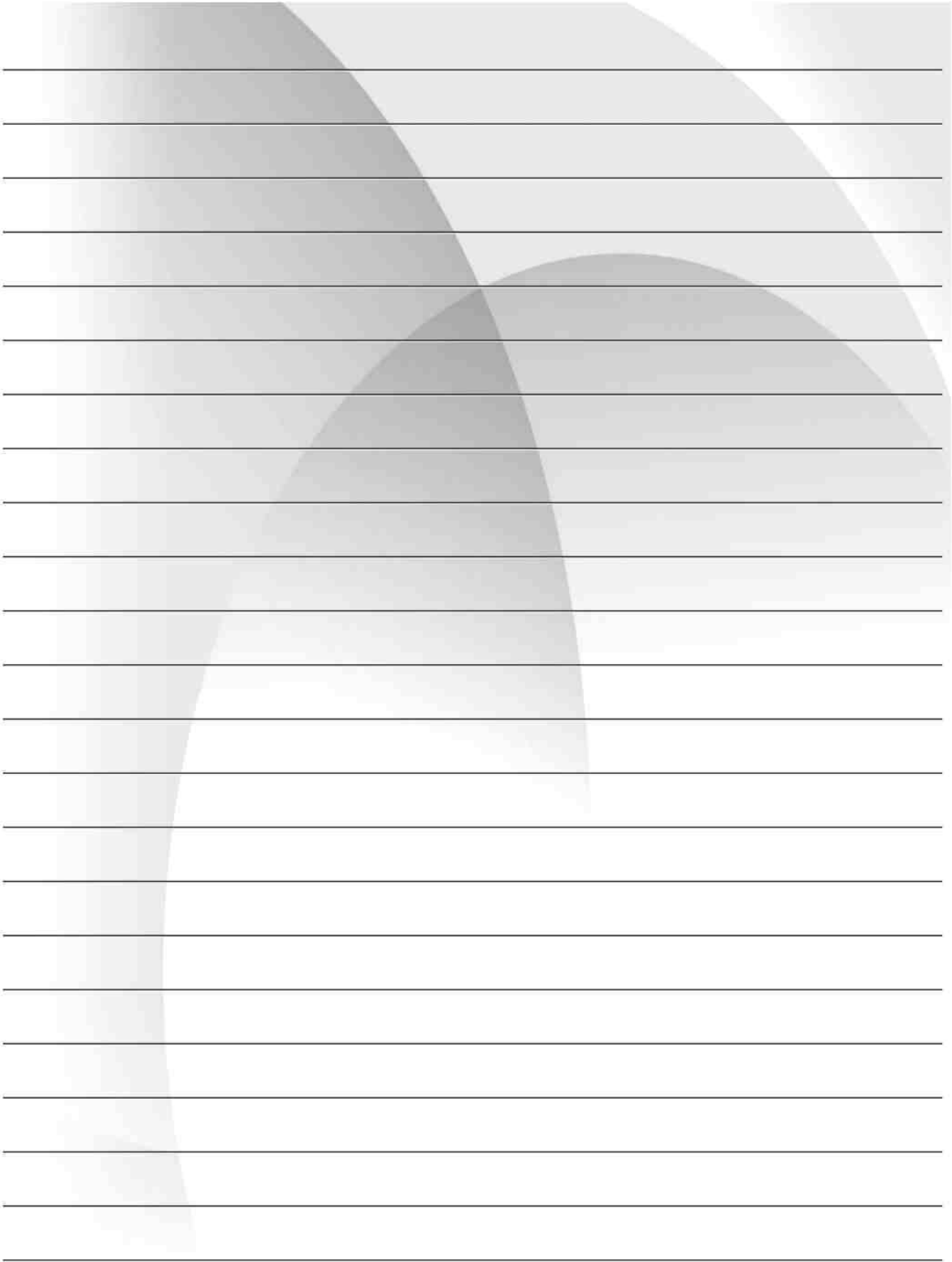

A large rectangular area for writing, featuring horizontal lines. A large, semi-transparent grey watermark graphic, consisting of overlapping curved shapes, is centered on the page.

ASC MEDICAL Surgical Instruments and Implants are guaranteed to be free of defects in materials and workmanship for life.

ASC MEDICAL Surgical Instruments and Implants that are determined to be defective will be replaced or repaired, at our discretion.

ASC MEDICAL Surgical Instruments and Implants not properly cared for or used for purposes not intended will not be covered.

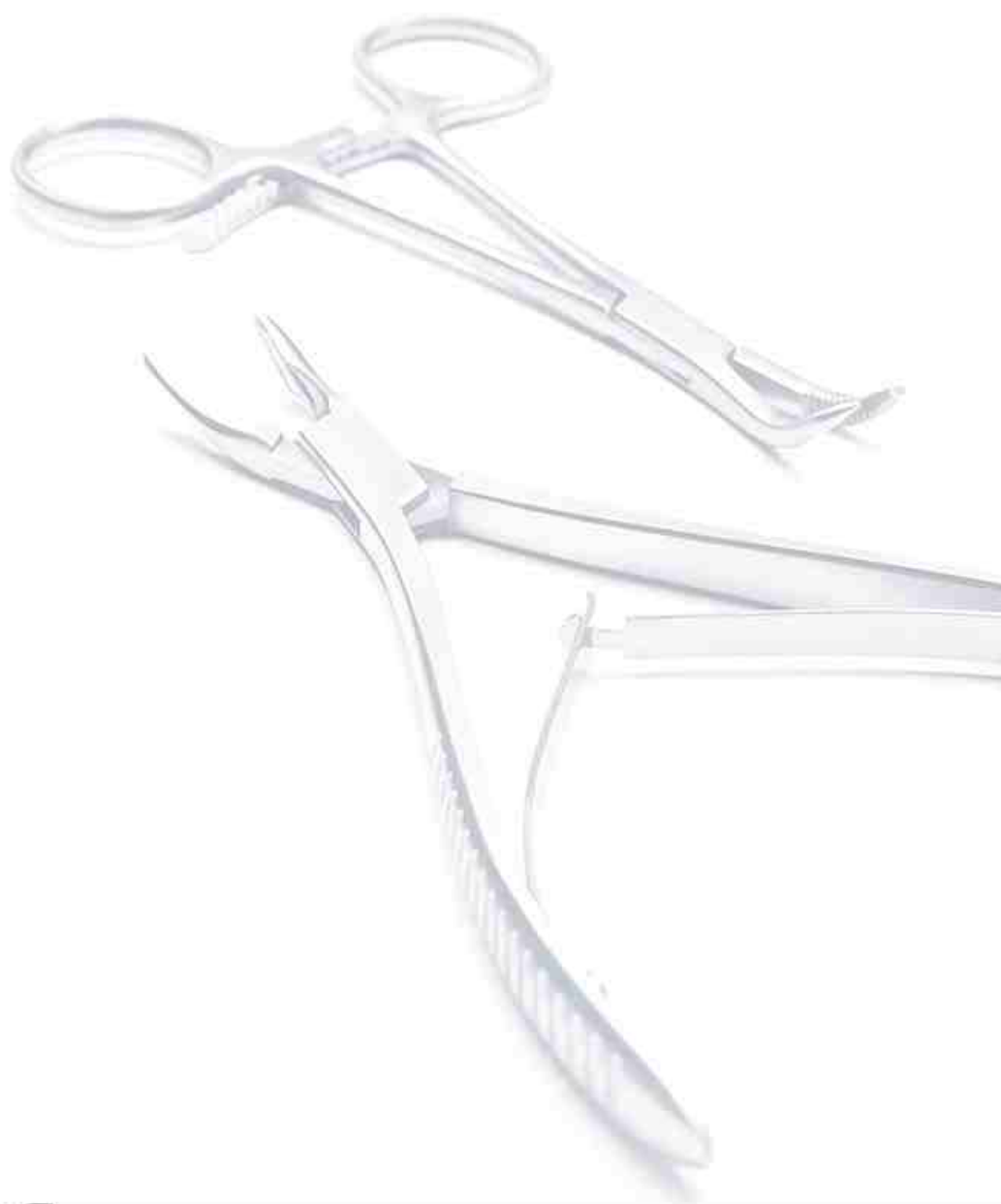

ASC Medical GmbH & Company KG
take-off GewerbePark 2
78579 Neuhausen o.E. | Tuttlingen, Germany

Phone: + 49 (0) 7467 - 94 960 46
Fax: + 49 (0) 7467 - 94 960 49
www.asc-med.com - info@asc-med.com