



Ear, Nose & Throat Instruments





Welcome to ASC Medical GmbH & Co. KG.

The company was founded by Kurt Bucher in the year 2003.

The **ASC MEDICAL** office is located in the heart of Southern Germany, Neuhausen / Tuttlingen.

ASC MEDICAL is dedicated to educating the market on new and improved techniques, implants and instrumentation.

Since the formation of **ASC MEDICAL**, we have dedicated ourselves of bringing instruments and implants at a competitive value to the Medical Market. We are proud of what we have achieved in the last 7 years and look forward to more of the same for many years to come.

When you purchase from **ASC MEDICAL**, you are guaranteed the best in quality and customer service. We not only meet your expectations, we exceed them!

This is what we set out to deliver and has since become known as the "**ASC MEDICAL Philosophy**".

On behalf of the **ASC MEDICAL** team members and our distribution partners, we thank you for your tremendous trust in the past. And with your support, we will continue to deliver the highest quality surgical instruments and implants on the market.

Kurt Bucher
President

Otology	1-24
Rhinology	25-43
Tonsil	44-52
Esophagoscopy	52-57
Tracheotomy	58-62

Special Note:

ASC is carrying the full range of over 18000 different surgical instruments.
Please do not hesitate to contact us for any instruments which you do not find in this catalogue.

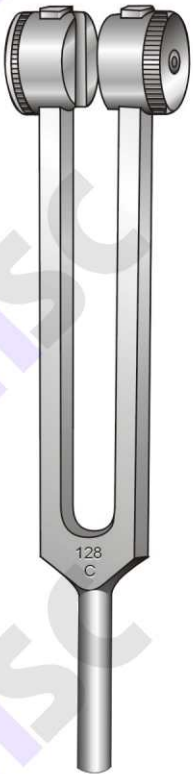

Alloy
36-3001-00
C 128

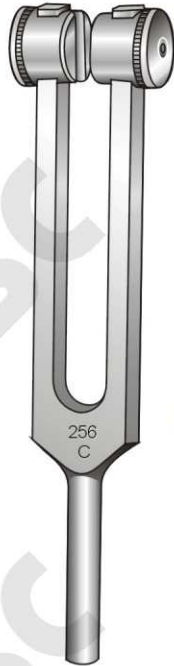

Alloy
36-3005-00
C' 256



Alloy
36-3010-00
C' 512



Alloy
36-3015-00
C' 1024



Alloy
36-3020-00
C' 2048

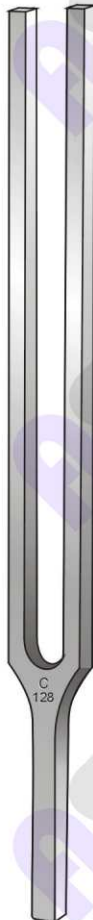

Hartmann
36-3025-00
C 128

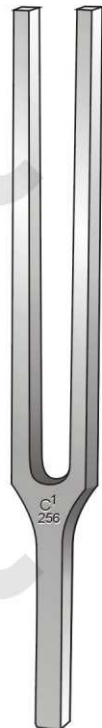

Hartmann
36-3030-00
C' 256

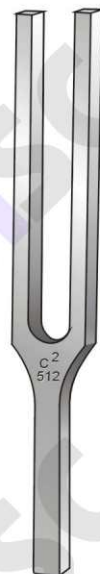

Hartmann
36-3035-00
C' 512



Hartmann
36-3040-00
C' 1024



Hartmann
36-3045-00
C' 2048



Hartmann
36-3050-00
C' 4096

Tuning Forks
Stimmgabeln
Diapasones

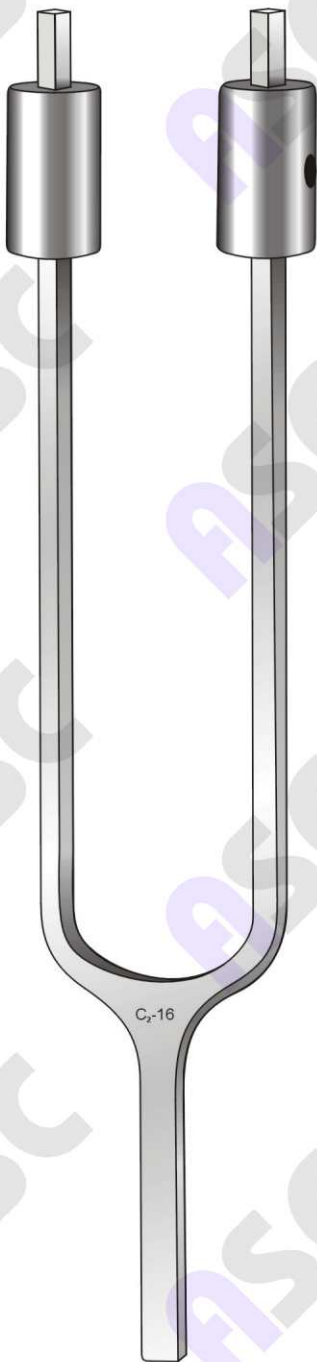

French
36-3055-00
C₇ 16

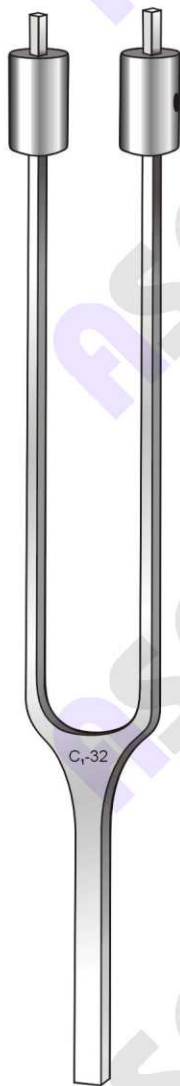

French
36-3060-00
C₇ 32

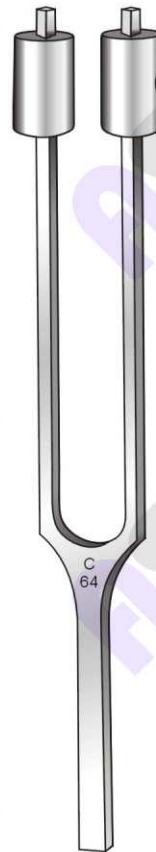

Hartmann
36-3063-00
C 64



Hartmann
36-3065-00
C 128



Hartmann
36-3070-00
C' 256

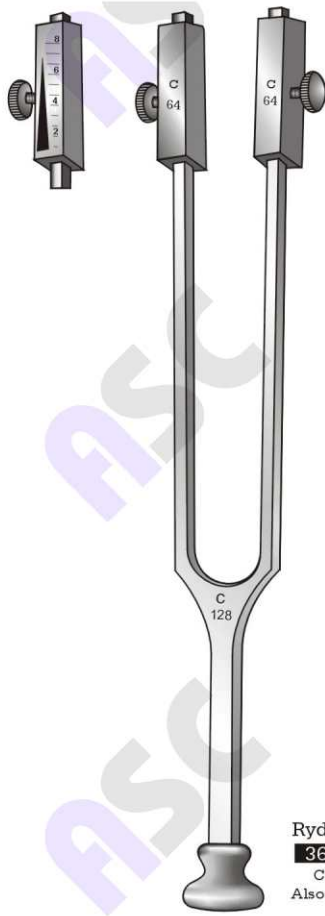

Rydel-Seiffert
36-3075-00
C 64 / C 128
Also for neurology

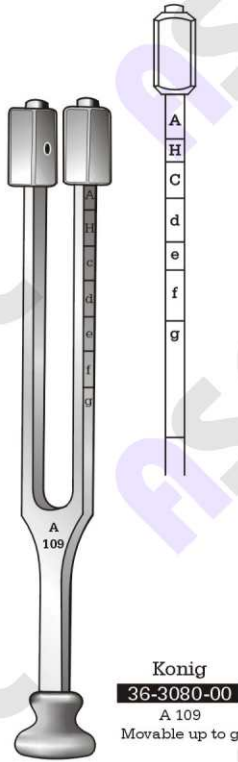

Konig
36-3080-00
A 109
Movable up to g

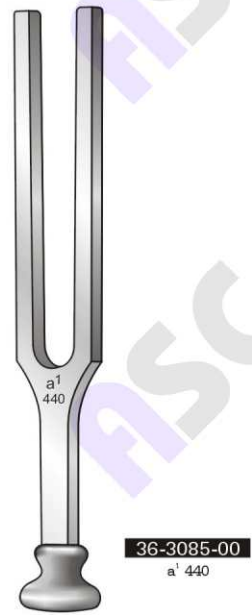

36-3085-00
a¹ 440

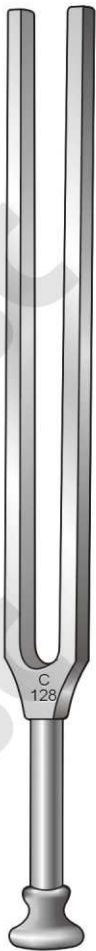

Lucae
36-3090-00
C 128



Lucae
36-3095-00
c¹ 256



Lucae
36-3101-00
C² 512



Lucae
36-3105-00
C³ 1024



Lucae
36-3110-00
C⁴ 2048



Lucae
36-3115-00
c⁵ 4096

Ear Specula
Ohrspekula
Especulos auriculares



Troeltsch
36-3120-00
Set of 3



36-3121-00
6 mmØ
Fig. 1



36-3122-00
7 mmØ
Fig. 2



36-3123-00
8 mmØ
Fig. 3



Hartmann
36-3125-00
Set of 5



36-3126-00
3 mmØ
Fig. 1



36-3127-00
4 mmØ
Fig. 2



36-3129-00
6 mmØ
Fig. 4



36-3128-00
5 mmØ
Fig. 3



36-3130-00
7 mmØ
Fig. 5



Hartmann
36-3135-00
Set of 4



36-3136-00
4.5 mmØ
Fig. 1



36-3138-00
6.5 mmØ
Fig. 3



36-3137-00
5.5 mmØ
Fig. 2



36-3139-00
7.5 mmØ
Fig. 4



Toynbee
36-3140-00
Set of 5



36-3141-00
4.5 mmØ
Fig. 1



36-3143-00
6.5 mmØ
Fig. 3



36-3142-00
5.5 mmØ
Fig. 2



36-3144-00
7.5 mmØ
Fig. 4



Politzer
36-3150-00
Set of 4



36-3151-00
3 mmØ
Fig. 1



36-3153-00
5.5 mmØ
Fig. 3



36-3152-00
4.5 mmØ
Fig. 2



36-3154-00
6.5 mmØ
Fig. 4



Pritchard
36-3160-00
Set of 3



36-3161-00
4.5 mmØ
Fig. 1



36-3162-00
6.5 mmØ
Fig. 2



36-3163-00
7.5 mmØ
Fig. 3



Erhardt
36-3165-00 Round
36-3170-00 Oval
Set of 3



36-3166-00
4.5 mmØ
Fig. 1



36-3167-00
5.5 mmØ
Fig. 3



36-3168-00
6.5 mmØ
Fig. 5



36-3171-00
4.5 mmØ
Fig. 2



36-3172-00
5.5 mmØ
Fig. 4



36-3173-00
6.5 mmØ
Fig. 6



Gruber
36-3175-00 Round
36-3185-00 Oval
Set of 3



36-3176-00
4.5 mmØ
Fig. 1



36-3177-00
5.5 mmØ
Fig. 3



36-3178-00
6.5 mmØ
Fig. 5



36-3179-00
7.5 mmØ
Fig. 7



36-3186-00
4.5 mmØ
Fig. 2



36-3187-00
5.5 mmØ
Fig. 4



36-3188-00
6.5 mmØ
Fig. 6



36-3189-00
7.5 mmØ
Fig. 8

Ear Specula Storage Rack
Ohrspekulaständer
Soportes para espejos auriculares



36-3196-00
5.5 x 6.5 mm
Fig. 1



36-3197-00
6.5 x 7.5 mm
Fig. 2



36-3198-00
7.5 x 8.5 mm
Fig. 3



36-3199-00
8.5 x 9.5 mm
Fig. 4



36-3201-00
9.5 x 10.5 mm
Fig. 5



36-3202-00
10.5 x 11.5 mm
Fig. 6



36-3205-03
5.5 mmØ
Fig. 1



36-3206-03
6.5 mmØ
Fig. 2



36-3207-03
7.5 mmØ
Fig. 3



36-3208-03
8.5 mmØ
Fig. 4



36-3209-03
9.5 mmØ
Fig. 5



36-3210-03
10.5 mmØ
Fig. 6



36-3211-03
11.5 mmØ
Fig. 7



Zollner
36-3195-00
3.8 cm / 1½"
Set of 6 pieces
Oval, Black



36-3212-03
Set of 7 pieces

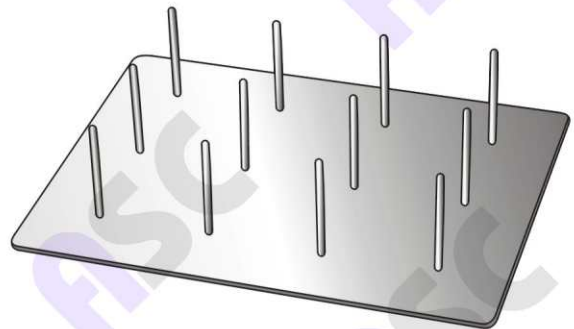

36-3215-00
Ear specula storage rack



36-3221-00
3 x 4 mm
Fig. 1



36-3222-00
4 x 5 mm
Fig. 2



36-3223-00
4.5 x 5.5 mm
Fig. 3



36-3224-00
5 x 6 mm
Fig. 4



36-3225-00
5.5 x 6.5 mm
Fig. 5



36-3226-00
6 x 7 mm
Fig. 6



36-3227-00
6.5 x 7.5 mm
Fig. 7



36-3228-00
7 x 8 mm
Fig. 8



36-3229-00
7.5 x 8.5 mm
Fig. 9



36-3220-00
Oval, angled end
Set of 9 pieces



36-3236-00
Round
Fig. 1



36-3237-00
Round
Fig. 2



36-3238-00
Round
Fig. 3



36-3239-00
Round
Fig. 4



Boucheron
36-3235-00
Set of 4, round

Specula, Ear Syring Catheters
Spekula, Ohrkatheterspritzen
Especúlos, Catéteres y jeringas auriculares

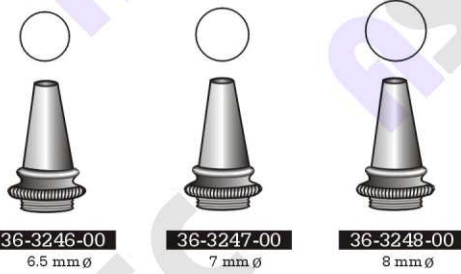

36-3246-00
6.5 mm Ø

36-3247-00
7 mm Ø

36-3248-00
8 mm Ø

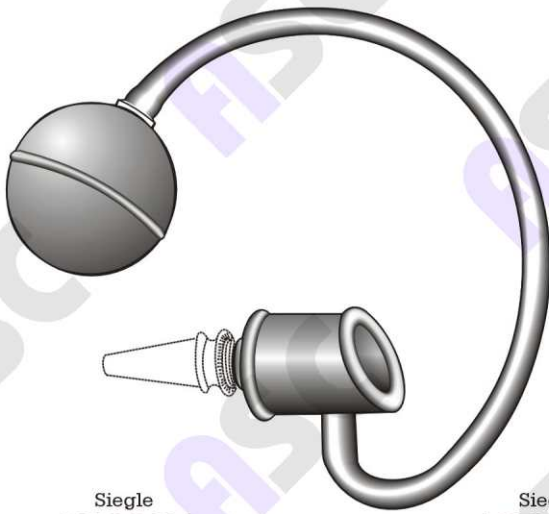

Siegle
36-3249-00
Complete set

Siegle
36-3245-00

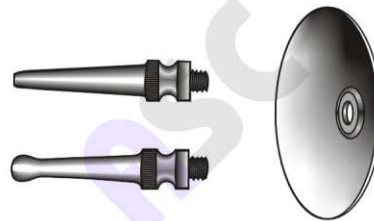

Pimeroy

36-3250-00	50 c.c.
36-3251-00	75 c.c.
36-3252-00	100 c.c.
36-3253-00	150 c.c.
36-3254-00	200 c.c.

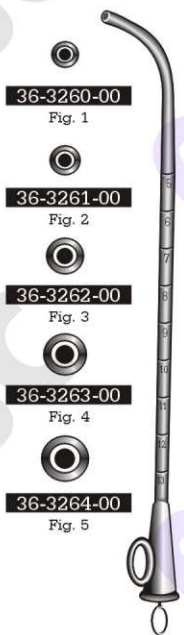

- 36-3260-00**
Fig. 1
- 36-3261-00**
Fig. 2
- 36-3262-00**
Fig. 3
- 36-3263-00**
Fig. 4
- 36-3264-00**
Fig. 5

Troeltsch



- 36-3270-00**
Fig. 1
- 36-3271-00**
Fig. 2
- 36-3272-00**
Fig. 3

Hartmann
15 cm / 6"



- 36-3275-00**
Fig. 0
- 36-3276-00**
Fig. 1
- 36-3277-00**
Fig. 2
- 36-3278-00**
Fig. 3
- 36-3279-00**
Fig. 4
- 36-3280-00**
Fig. 5

Hartmann



- 36-3285-00**
Fig. 1
- 36-3286-00**
Fig. 2
- 36-3287-00**
Fig. 3
- 36-3288-00**
Fig. 4
- 36-3289-00**
Fig. 5

Lucae

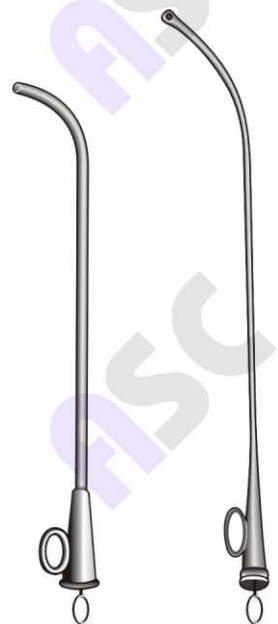

Woakes
36-3295-00



36-3301-00
Ear syringe, complete
self filling in plastic pouch

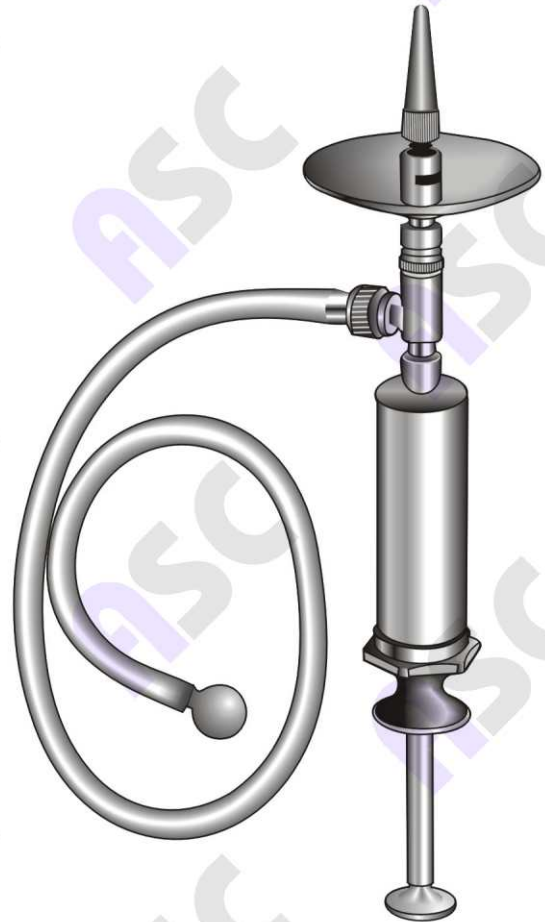

36-3305-00
Flexible tube

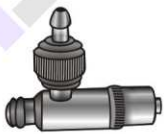

36-3310-00
Valve attachment



36-3315-00
Suction nozzle



36-3320-00
Protecting disc



36-3325-00
Metal olive



36-3330-00
Conical tip



36-3335-00
Button ended tip



36-3340-00
Threaded tip



36-3345-00 50 ml
36-3346-00 75 ml
36-3347-00 100 ml
Ear syringe, complete with
protecting disc and 2 tips

Air Bags
Luftduschen
Insufladores de aire



36-3355-00
Connecting nozzle



36-3360-00
4 mm Ø
Ear olive



36-3365-00
15 mm Ø
Nose olive



36-3370-00
17 mm Ø
Nose olive



36-3375-00
22 mm Ø
Nose olive



Politzer
36-3351-00
36-3350-00
Complete set

Micro Ear Needles, Micro Ear Hooks
Mikro-Ohrnadeln, Mikro-Ohrhäkchen
Micro agujas auriculares, Micro ganchitos auriculares



Barbara
16 cm / 6¼"



Barbara
36-3380-16



Barbara
36-3385-16



Barbara
36-3390-16



Rosen
36-3395-16
16 cm / 6¼"



25°
36-3401-16 0.3 mm
36-3402-16 0.6 mm
36-3403-16 1.0 mm



45°
36-3405-16 0.3 mm
36-3406-16 0.6 mm
36-3407-16 1.0 mm
36-3408-16 1.2 mm
36-3409-16 1.5 mm
36-3410-16 2.0 mm
36-3411-16 2.5 mm



90°
36-3415-16 0.3 mm
36-3416-16 0.6 mm
36-3417-16 1.0 mm
36-3418-16 1.2 mm
36-3419-16 1.5 mm
36-3420-16 2.0 mm
36-3421-16 2.5 mm



36-3425-16 0.5 mm
36-3426-16 1.0 mm



90°
36-3430-15 0.3 mm
36-3431-15 0.6 mm
36-3432-15 1.0 mm



90°
36-3435-15 0.3 mm
36-3436-15 0.6 mm
36-3437-15 1.0 mm



McGee
36-3440-15 0.5 mm
36-3441-15 1.0 mm
For footplate



McGee
36-3445-15 0.5 mm
36-3446-15 1.0 mm
For footplate



36-3450-15



36-3455-15



15.5 cm / 6"



Barbara
15.5 cm / 6"

Micro Ear Hooks, Micro Dissectors
 Mikro-Ohrhäkchen, Mikro-Dissektoren
 Micro ganchitos auriculares, Micro disecadores



36-3460-00 0.3 mm	36-3465-00 0.6 mm	Shambaugh 36-3470-00 1.0 mm	36-3475-00 0.3 mm	36-3480-00 0.6 mm	Shambaugh 36-3485-00 1.0 mm	Shea 36-3490-00 2.0 mm Exploring hook Blunt	Austin 36-3495-00 3.0 mm Attic dissector Blunt

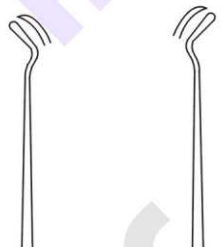

36-3501-15 Angled to right
36-3502-15 Angled to left

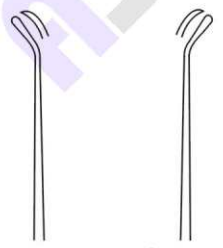

36-3503-15 Angled to right
36-3504-15 Angled to left



Fisch
15.5 cm / 6"



Rosen
36-3510-15
15.5 cm / 6"
Micro ear periosteal elevator



36-3515-15
3.5 mm



36-3516-15
4.0 mm



36-3517-15
4.5 mm



36-3518-15
5.0 mm



House
15.5 cm / 6"
Micro measuring rod

Micro Curettes, Tympanum Needles
Mikro-Küretten, Trommelfellnadeln
Micro cucharillas, Agujas para timpano

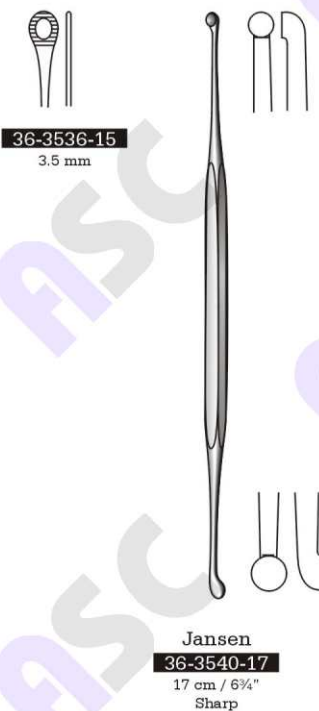
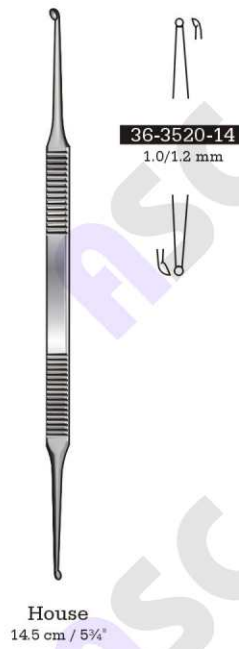

Micro Ear Knives
Mikro-Ohrmesser
Micro cuchillos auriculares



Schuknecht
36-3560-00
Rotary knife



Schuknecht
36-3565-14
14.5 cm / 5 3/4"
Sickle knife

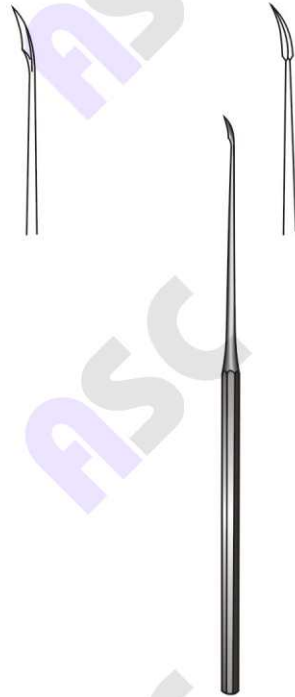

Wullstein
36-3570-15
15.5 cm / 6"
Sickle knife



Tabb
36-3575-00
Mucosa knife



Plester
36-3580-15
15 cm / 6"
Flap knife



Rosen
15 cm / 6"
Circular cut knives



36-3585-15
1 mmØ
Fig. 7



36-3586-15
1.4 mmØ
Fig. 6



36-3587-15
1.6 mmØ
Fig. 5



36-3588-15
2 mmØ
Fig. 4



36-3589-15
2.6 mmØ
Fig. 3



36-3590-15
2.8 mmØ
Fig. 2



36-3591-15
3 mmØ
Fig. 1

Tympanum Needles, Curettes, Scoop
Trommelfellnadeln, Küretten, Löffel
Agujas para tímpano, Curetas, Cuchrillas

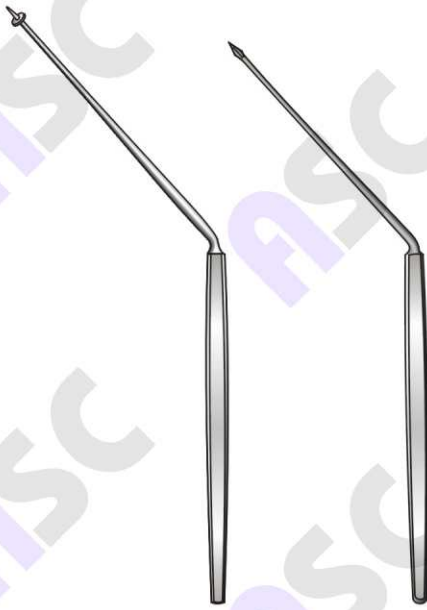

Troeltsch
36-3595-18
18 cm / 7"



Politzer
36-3601-16
16.5 cm / 6½"

Politzer
36-3605-16
16.5 cm / 6½"
Needle horizontally

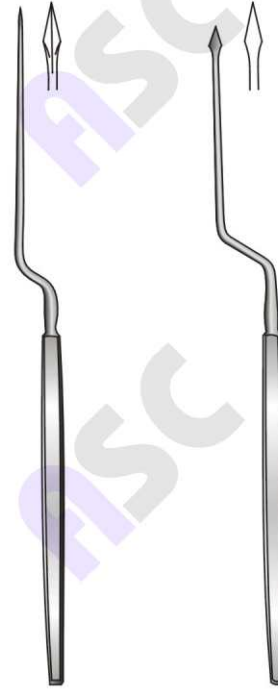

Lucae
36-3610-18
18 cm / 7"

Lucae
36-3615-18
18 cm / 7"



Barker
36-3620-17
17 cm / 6¾"



Gross
36-3625-12
12 cm / 4¾"
Blunt / Sharp



Gross
36-3630-12
12 cm / 4¾"
Ear scoop / hook
Blunt



Gross
36-3635-12
12 cm / 4¾"
Blunt



Gross
36-3640-12
12 cm / 4¾"
Blunt / Sharp



Gross
36-3645-12
12 cm / 4¾"



Billeau
16.5 cm / 6½"
Ear loop

36-3650-16
2.75 mm

36-3651-16
3.75 mm

36-3652-16
5.5 mm

Foreign Body Instruments
Fremdkörperinstrumente
Instrumentos para cuerpos extraños



Weber-Loch
36-3655-16
16.5 cm / 6½"
Ear loop

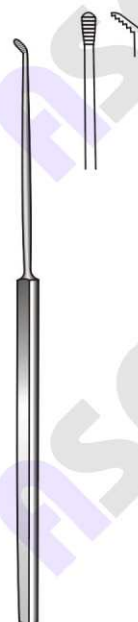

Moldenhauer
36-3660-15
15.5 cm / 6"
Foreign body lever

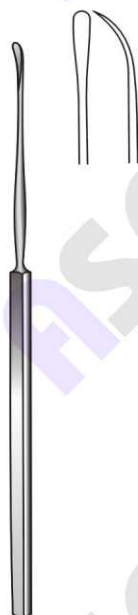

Zaufal
36-3665-15
15 cm / 6"
Foreign body lever



Hartmann
36-3670-16
16 cm / 6¼"
Sharp, ear hooklet

Ear Hooklets
Ohrhäkchen
Ganchitos auriculares



Lucae
14 cm / 5½"

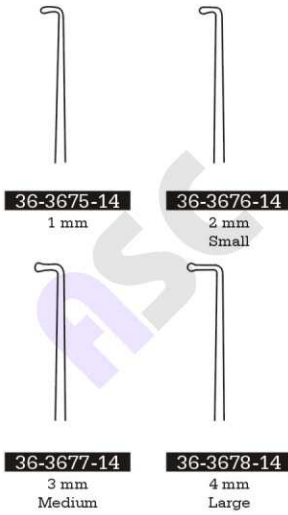

Day
17 cm / 6¾"
Delicate
Ear hook

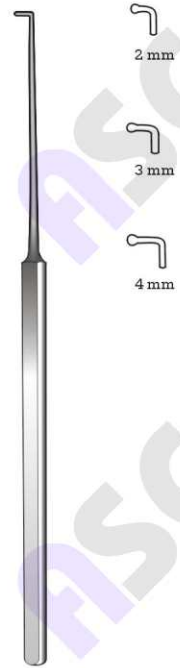
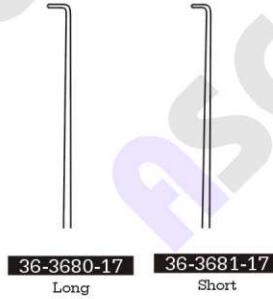

Mastoid Ear Searcher
36-3685-00 2 mm
36-3686-00 3 mm
36-3687-00 4 mm
Ear hook, american made



Wagener
14 cm / 5½"

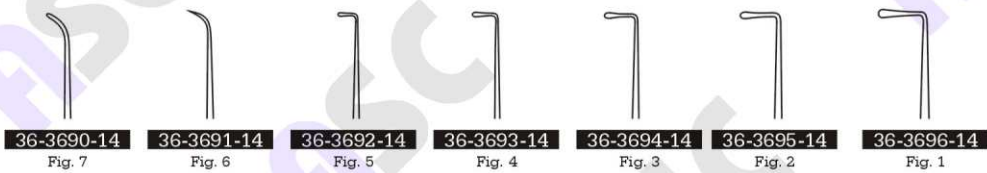

Ear Periosteal Elevators, Ear Scoops
Ohrraspatorien, Ohrlöffel
Legras auriculares, Cucharillas auriculares



Lempert
36-3701-20
20.5 cm / 8"
6 mm

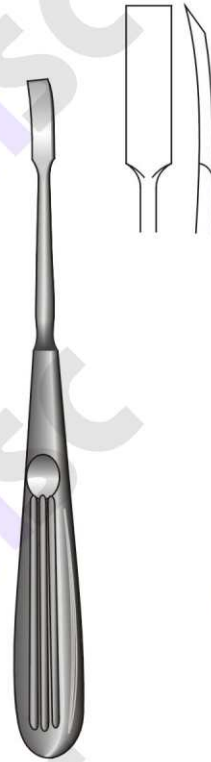

Lempert
36-3705-18
18 cm / 7"
6 mm



Lempert
21.5 cm / 8½"
Sharp



36-3710-21 **36-3711-21** **36-3712-21**



36-3713-21 **36-3714-21**

Adenoid Currettes
Ringmesser
Cuchillos para vegetaciones adenoides



Myles
17 cm / 6 3/4"



Faulkner
37-3975-21
21 cm / 8 1/4"



Coakley
17 cm / 6 3/4"



Beckmann
22 cm / 8 3/4"
Trapezoidal fenestrated



Adenoid Currettes, Bone Currettes, Curette Sharpener
Ringmesser, Scharfe Küretten, Kürettenschärfer
Cuchillos para vegetaciones adenoides, Curetas cortantes, Afilador para curetas



Beckmann
22 cm / 8 3/4"



37-4001-22
Fig. 1

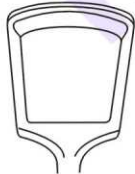

37-4002-22
Fig. 2



37-4003-22
Fig. 3



37-4004-22
Fig. 4

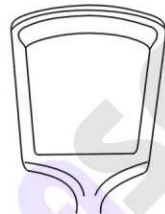

37-4005-22
Fig. 5

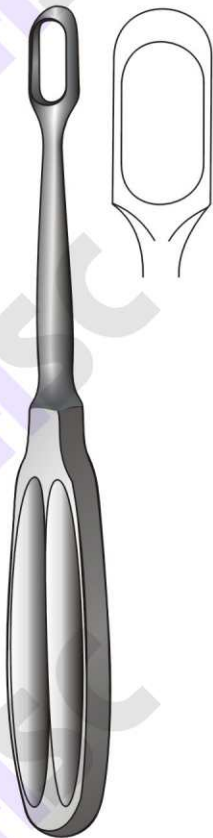

Tessier
37-4010-21
21.5 cm / 8 1/2"
12 mm



Tessier
37-4015-19
19.5 cm / 7 3/4"
Curette sharpener



Tessier
37-4020-21
21.5 cm / 8 1/2"
6 mm

Adenoid Curettes, Cannulas
Ringmesser, Kanülen
Cuchillos para vegetaciones adenoides, Sondas

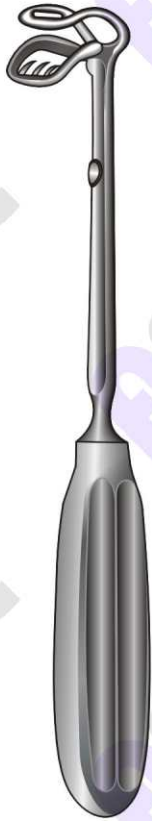

St. Clair-Thomson
21 cm / 8 1/4"



37-4025-21
11 mm



37-4026-21
13 mm



37-4027-21
15 mm



37-4028-21
17 mm



Hartmann

Fig. 1	mm Ø	Fig. 2
37-4030-00	2 mm	37-4035-00
37-4031-00	2.5 mm	37-4036-00
37-4032-00	3 mm	37-4037-00



Hartmann
37-4040-00 2 mm Ø
37-4041-00 2.5 mm Ø
37-4042-00 3 mm Ø
12 cm / 4 1/4"



Eicken-Killian
37-4045-00
14 cm / 5 1/2"
3 mm Ø
Irrigation cannula



Eicken-Killian
37-4050-00
14 cm / 5 1/2"
3 mm Ø



Killian
37-4055-00
17 cm / 6 3/4"
1 1/2 mm Ø



Marchac
37-4060-19
19 cm / 7 1/2"

Ear Currettes
Ohrküretten
Curetetas auriculares



Buck
16.5 cm / 6½"



- 36-3720-16 Fig. 000
- 36-3721-16 Fig. 00
- 36-3722-16 Fig. 0
- 36-3723-16 Fig. 1
- 36-3724-16 Fig. 2
- 36-3725-16 Fig. 3
- 36-3726-16 Fig. 4
- 36-3727-16 Fig. 5

Blunt



- 36-3730-16
- 36-3731-16
- 36-3732-16
- 36-3733-16
- 36-3734-16
- 36-3735-16
- 36-3736-16
- 36-3737-16

Sharp



Fig. 000



Fig. 00



Fig. 0



Fig. 1



Fig. 2



Fig. 3



Fig. 4



Fig. 5



- 36-3740-16 Fig. 000
- 36-3741-16 Fig. 00
- 36-3742-16 Fig. 0
- 36-3743-16 Fig. 1
- 36-3744-16 Fig. 2
- 36-3745-16 Fig. 3
- 36-3746-16 Fig. 4
- 36-3747-16 Fig. 5

Round handle
Blunt



- 36-3750-16 Fig. 000
- 36-3751-16 Fig. 00
- 36-3752-16 Fig. 0
- 36-3753-16 Fig. 1
- 36-3754-16 Fig. 2
- 36-3755-16 Fig. 3
- 36-3756-16 Fig. 4
- 36-3757-16 Fig. 5

Round handle
Sharp

Buck
16.5 cm / 6½"
extra extra fine



- 36-3760-16 Fig. 000
- 36-3761-16 Fig. 00
- 36-3762-16 Fig. 0
- 36-3763-16 Fig. 1
- 36-3764-16 Fig. 2
- 36-3765-16 Fig. 3
- 36-3766-16 Fig. 4
- 36-3767-16 Fig. 5

Octagonal handle
Blunt



- 36-3770-16 Fig. 000
- 36-3771-16 Fig. 00
- 36-3772-16 Fig. 0
- 36-3773-16 Fig. 1
- 36-3774-16 Fig. 2
- 36-3775-16 Fig. 3
- 36-3776-16 Fig. 4
- 36-3777-16 Fig. 5

Octagonal handle
Sharp

Buck
16.5 cm / 6½"



36-3780-17



36-3781-17



36-3782-17



36-3783-17



36-3784-17



36-3784-17



Myles
17 cm / 6¾"

Ear Polypus Snares and Foreign Body Forceps
Polypenzangen, Fremdkörperheber
Pinzas para polipos, Elevadores para cuerpos extraños



Littauer
36-3790-12
12 cm / 4 3/4"



Hartmann
36-3795-12
12 cm / 4 3/4"
Fine model

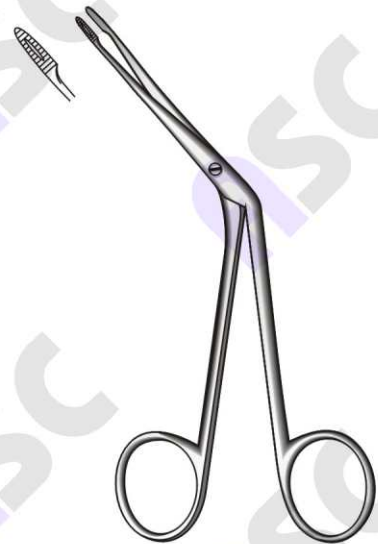

Hartmann
36-3801-14
14 cm / 5 1/2"
Regular model



Tilley
36-3805-16
16.5 cm / 6 1/2"

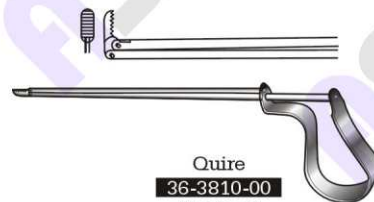

Quire
36-3810-00
10.5 cm / 4"
Foreign body lever

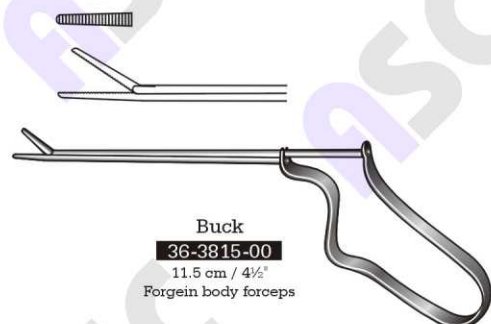

Buck
36-3815-00
11.5 cm / 4 1/2"
Foreign body forceps

Ear Polypus Forceps
Ohrpolypenzangen
Pinzas para polipos auriculares

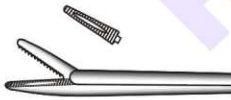

Hartmann
36-3820-08 8.5 cm / 3 1/2"
36-3820-12 12 cm / 4 3/4"
36-3820-14 14 cm / 5 1/2"
36-3820-16 16.5 cm / 6 1/2"



Hartmann Wullstein
36-3825-08
 8.5 cm / 3 1/2"



Hartmann Wullstein
36-3830-08
 8.5 cm / 3 1/2"

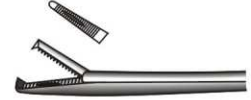

Hartmann
36-3835-08 8.5 cm / 3 1/2"
36-3835-12 12 cm / 4 3/4"
36-3835-14 14 cm / 5 1/2"
 1:2 Teeth



Hartmann Noyes
36-3840-09
 9 cm / 3 1/2"



Hartmann Noyes
36-3845-09
 9 cm / 3 1/2"
 1:2 Teeth



Hartmann Weingartner
36-3850-08
 8.5 cm / 3 1/2"



Hartmann
36-3855-08
 8.5 cm / 3 1/2"



Hartmann
36-3860-08 8.5 cm / 3 1/2"
36-3860-12 12 cm / 4 3/4"
36-3860-14 14 cm / 5 1/2"
 2 mm \emptyset
36-3861-08 8.5 cm / 3 1/2"
36-3861-12 12 cm / 4 3/4"
36-3861-14 14 cm / 5 1/2"
 2.5 mm \emptyset
36-3862-08 8.5 cm / 3 1/2"
36-3862-12 12 cm / 4 3/4"
36-3862-14 14 cm / 5 1/2"
 3 mm \emptyset

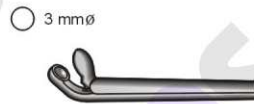

Hartmann
36-3865-08
 8.5 cm / 3 1/2"



Struempel
36-3870-08
 8.5 cm / 3 1/2"



Hartmann
36-3875-08
 8.5 cm / 3 1/2"



Hartmann
36-3880-08
 8.5 cm / 3 1/2"



Hartmann Hoffmann
36-3885-08
 8.5 cm / 3 1/2"

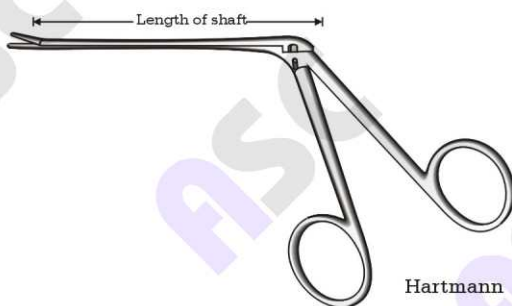

Micro Ear Forceps
Mikro-Ohrzängchen
Micro pinzas auriculares



36-3890-00

80 mm

36-3891-00

110 mm

Smooth, straight

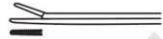

36-3895-00

80 mm

36-3896-00

110 mm

Serrated, straight



36-3901-00

80 mm

36-3902-00

110 mm

Serrated, upward

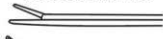

36-3905-00

80 mm

36-3906-00

110 mm

Serrated, Right

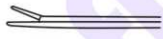

36-3910-00

80 mm

36-3911-00

110 mm

Serrated, Left



36-3915-00

80 mm

36-3916-00

110 mm

Smooth, straight



36-3920-00

80 mm

36-3921-00

110 mm

Serrated, straight

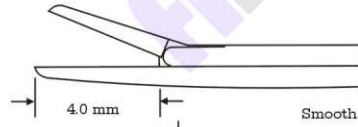

Smooth

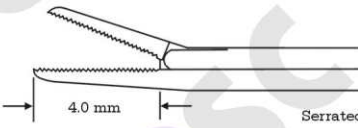

Serrated

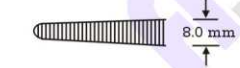

8.0 mm

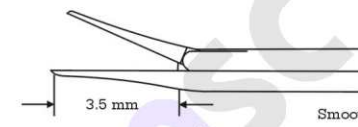

Smooth

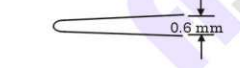

Serrated

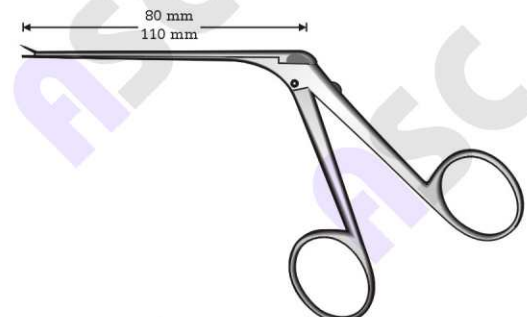
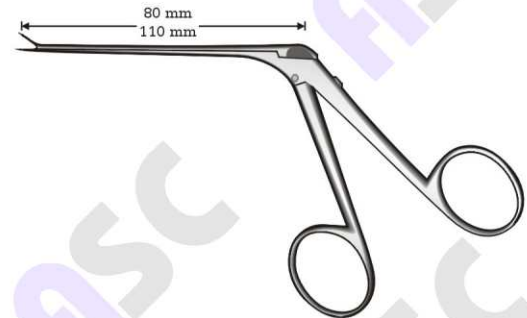

McGee-Mini

Micro Ear Forceps
Mikro-Ohrzängchen
Micro pinzas auriculares

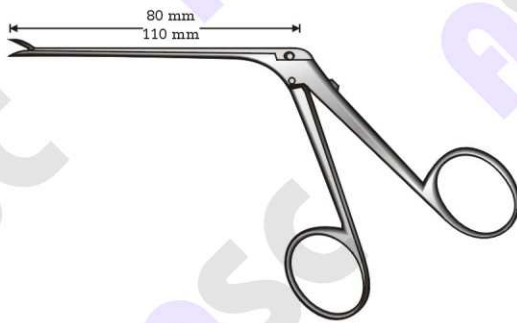
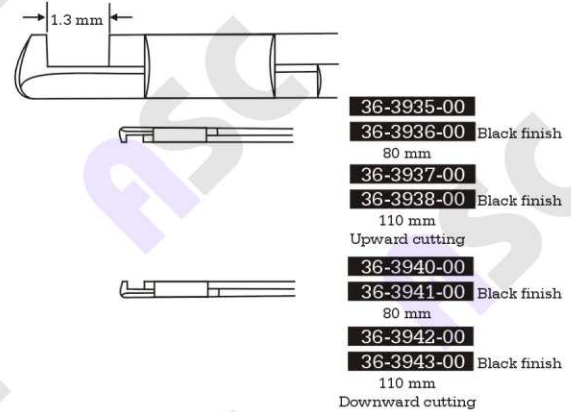
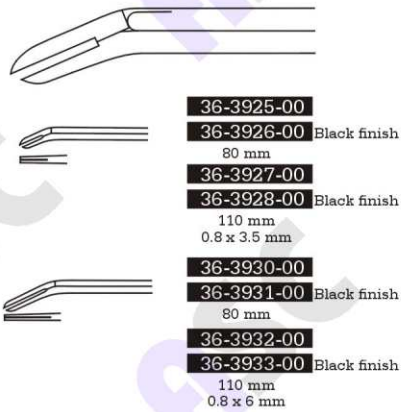

McGee
Wire bending forceps
bends downward

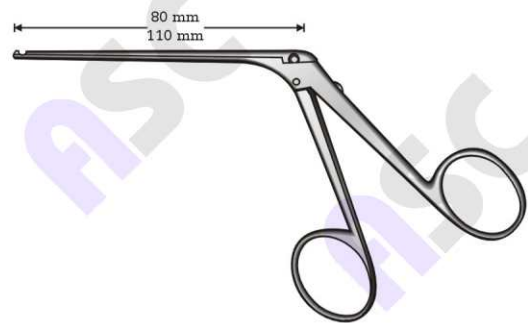

House-Dieter
Malleus nipper

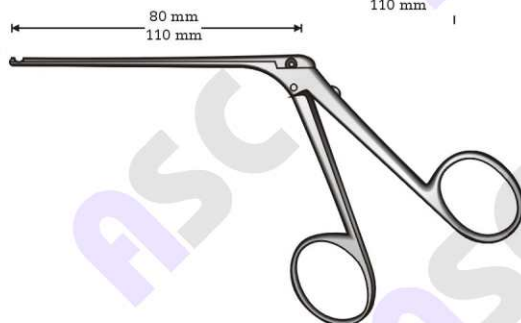
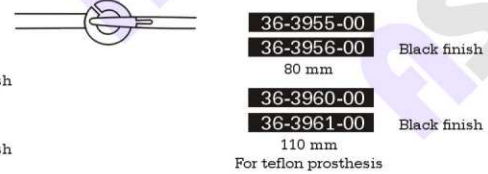
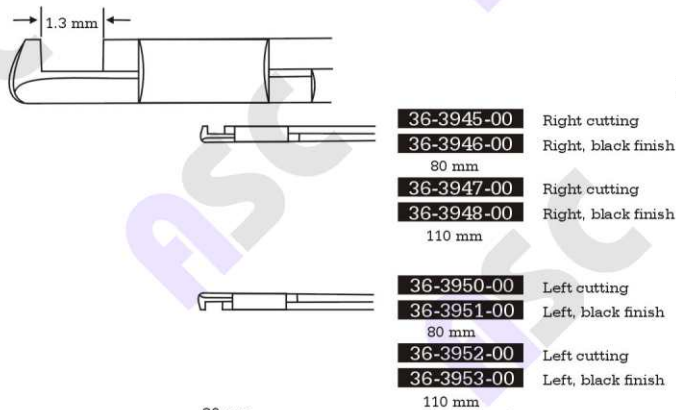



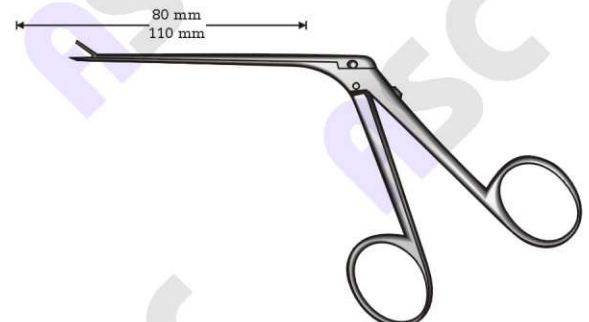

House-Dieter
Malleus nipper





Fuller
Introducing forceps

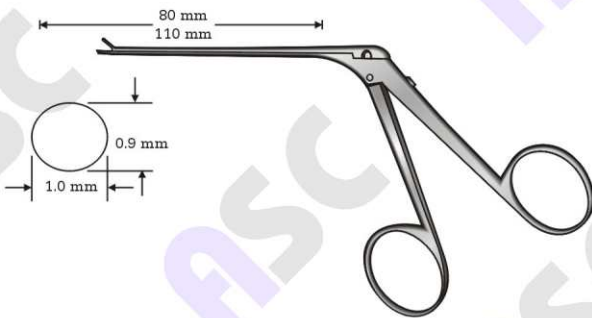

Micro Cup-Shaped-Forceps, Micro Ear Forceps
Mikro-Löffelzängchen, Mikro-Ohrzängchen
Micro pinzas con boca en forms de cucharilla, Micro pinzas auriculares

- | | |
|---|---|
|  |  |
| 36-3965-00 80 mm | 36-3970-00 |
| Straight | Curved up |
| 36-3966-00 80 mm | 36-3971-00 |
| Straight, black finish | Curved up, black finish |
| 36-3967-00 110 mm | 36-3972-00 |
| Straight | Curved up |
| 36-3968-00 110 mm | 36-3973-00 |
| Straight, black finish | Curved up, black finish |

- | | |
|---|---|
|  |  |
| 36-3975-00 80 mm | 36-3980-00 |
| Right | Left |
| 36-3976-00 80 mm | 36-3981-00 |
| Right, black finish | Left, black finish |
| 36-3977-00 110 mm | 36-3982-00 |
| Right | Left |
| 36-3978-00 110 mm | 36-3983-00 |
| Right, black finish | Left, black finish |



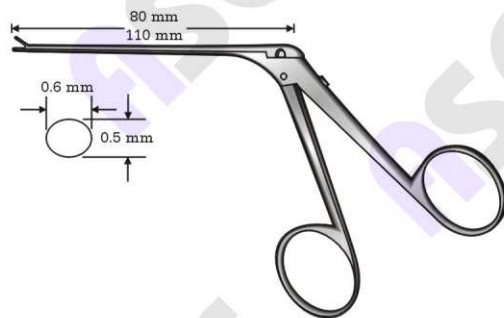

- | | |
|---|--|
|  |  |
| 36-3985-00 80 mm | 36-3990-00 |
| Straight | Curved up |
| 36-3986-00 80 mm | 36-3991-00 |
| Straight, black finish | Curved up, black finish |
| 36-3987-00 110 mm | 36-3992-00 |
| Straight | Curved up |
| 36-3988-00 110 mm | 36-3993-00 |
| Straight, black finish | Curved up, black finish |

- | | |
|---|---|
|  |  |
| 36-3995-00 80 mm | 36-4001-00 |
| Right | Left |
| 36-3996-00 80 mm | 36-4002-00 |
| Right, black finish | Left, black finish |
| 36-3997-00 110 mm | 36-4003-00 |
| Right | Left |
| 36-3998-00 110 mm | 36-4004-00 |
| Right, black finish | Left, black finish |

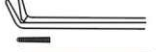

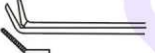
- | | |
|---|---|
|  |  |
| 36-4010-00 80 mm | 36-4015-00 |
| Straight | Curved up |
| 36-4011-00 80 mm | 36-4016-00 |
| Straight, black finish | Curved up, black finish |
| 36-4012-00 110 mm | 36-4017-00 |
| Straight | Curved up |
| 36-4013-00 110 mm | 36-4018-00 |
| Straight, black finish | Curved up, black finish |

- | | |
|---|---|
|  |  |
| 36-4020-00 80 mm | 36-4025-00 |
| Right | Left |
| 36-4021-00 80 mm | 36-4026-00 |
| Right, black finish | Left, black finish |
| 36-4022-00 110 mm | 36-4027-00 |
| Right | Left |
| 36-4023-00 110 mm | 36-4028-00 |
| Right, black finish | Left, black finish |

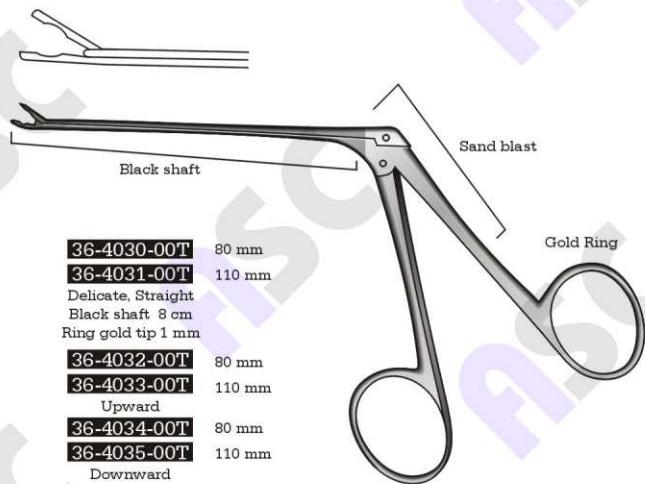
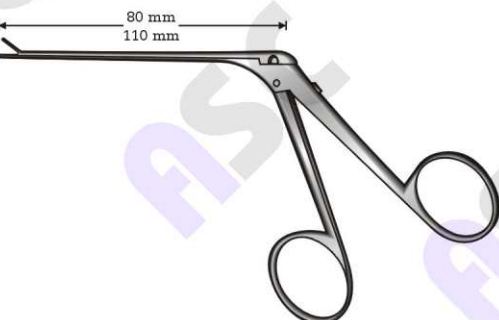

- | | |
|---------------------------|--|
| 36-4030-00T 80 mm | |
| 36-4031-00T 110 mm | |
| Delicate, Straight | |
| Black shaft 8 cm | |
| Ring gold tip 1 mm | |
| 36-4032-00T 80 mm | |
| 36-4033-00T 110 mm | |
| Upward | |
| 36-4034-00T 80 mm | |
| 36-4035-00T 110 mm | |
| Downward | |

Alligator Forceps
Delicate, Gold Ring
Tip 1 mm

Micro Ear Scissors
Mikro-Ohrscheren
Micro tijeras auriculares

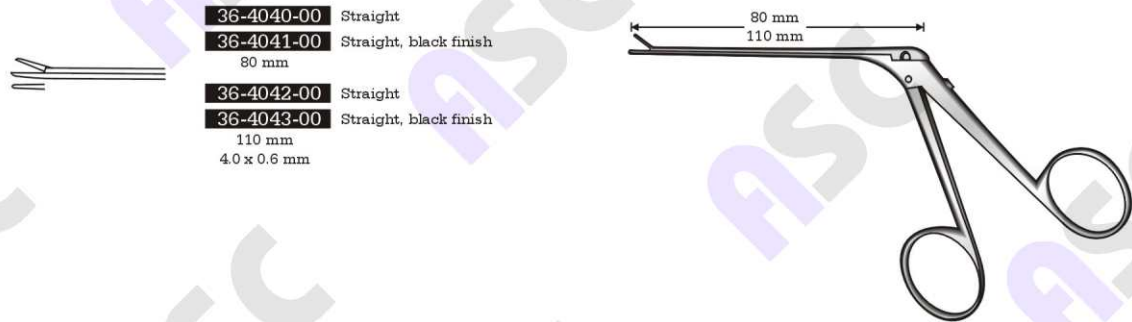

- 36-4040-00** Straight
- 36-4041-00** Straight, black finish
80 mm
- 36-4042-00** Straight
- 36-4043-00** Straight, black finish
110 mm
4.0 x 0.6 mm

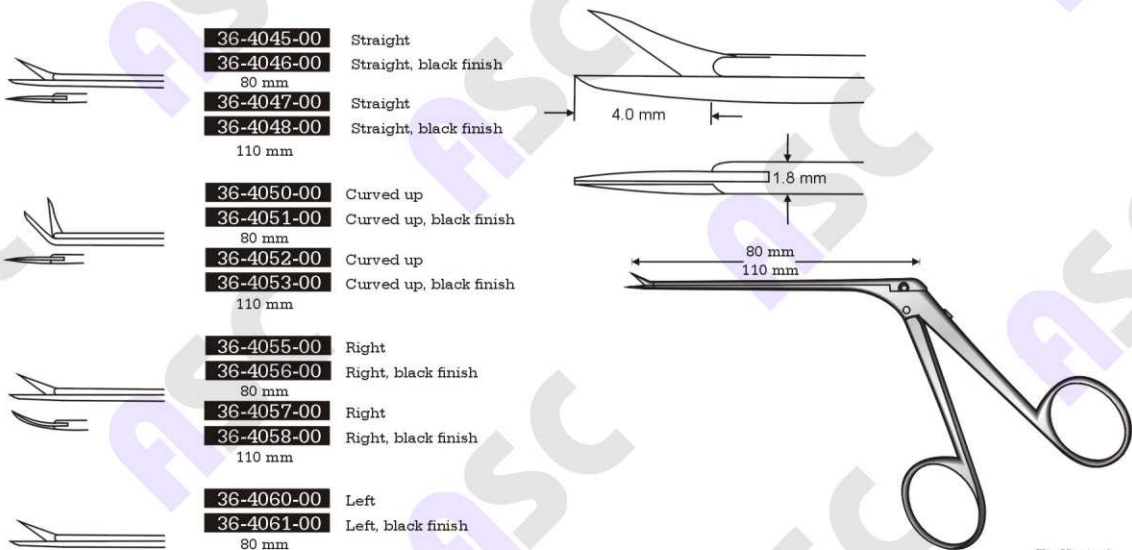

- 36-4045-00** Straight
- 36-4046-00** Straight, black finish
80 mm
- 36-4047-00** Straight
- 36-4048-00** Straight, black finish
110 mm
- 36-4050-00** Curved up
- 36-4051-00** Curved up, black finish
80 mm
- 36-4052-00** Curved up
- 36-4053-00** Curved up, black finish
110 mm
- 36-4055-00** Right
- 36-4056-00** Right, black finish
80 mm
- 36-4057-00** Right
- 36-4058-00** Right, black finish
110 mm
- 36-4060-00** Left
- 36-4061-00** Left, black finish
80 mm
- 36-4062-00** Left
- 36-4063-00** Left, black finish
110 mm

Bellucci
Very delicate

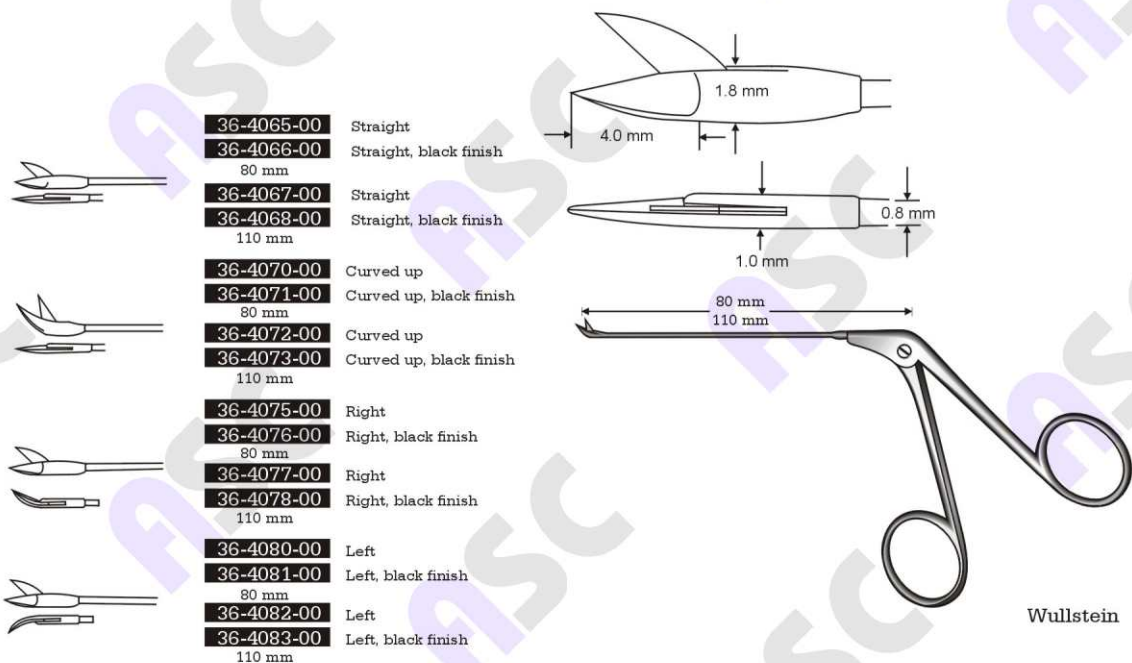

- 36-4065-00** Straight
- 36-4066-00** Straight, black finish
80 mm
- 36-4067-00** Straight
- 36-4068-00** Straight, black finish
110 mm
- 36-4070-00** Curved up
- 36-4071-00** Curved up, black finish
80 mm
- 36-4072-00** Curved up
- 36-4073-00** Curved up, black finish
110 mm
- 36-4075-00** Right
- 36-4076-00** Right, black finish
80 mm
- 36-4077-00** Right
- 36-4078-00** Right, black finish
110 mm
- 36-4080-00** Left
- 36-4081-00** Left, black finish
80 mm
- 36-4082-00** Left
- 36-4083-00** Left, black finish
110 mm

Wullstein

Wire Closure Forceps, Mastoid Rongeurs
Drahtbiegezängchen, Ohr-Knochenstanzen
Pinzas para doblar alambre, Pinzas cortantes para huesos

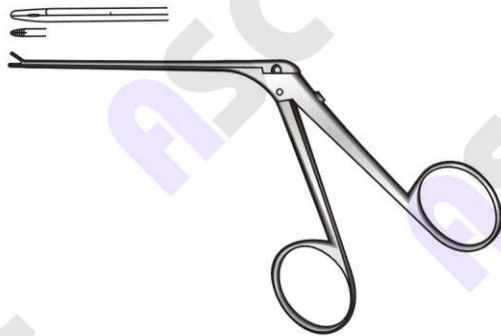

Greven
36-4085-00

2 mm

3 mm



Citelli
36-4090-00 2 mm
36-4091-00 3 mm

2 mm



Beyer
36-4095-00

1 mm



Beyer
36-4101-00

Nasal Specula
Nasenspekula
Especulos nasales

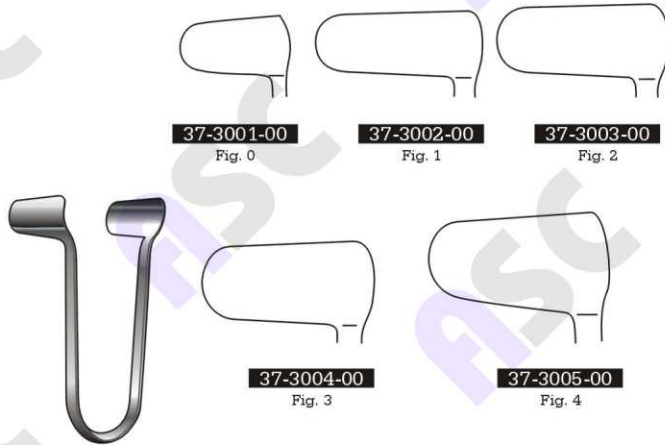

Goldsmith Thudichum



St. Clair Thomson

- 37-3010-00** Fig. 1, 35 mm
- 37-3011-00** Fig. 2, 50 mm
- 37-3012-00** Fig. 3, 75 mm



Voltolini

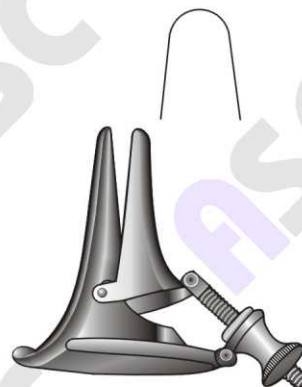

Vacher

37-3020-00



Yankauer

37-3025-19
19 cm / 7½"

Nasal Specula
Nasenspekula
Especulos nasales



Hartmann
16.5 cm / 6½"

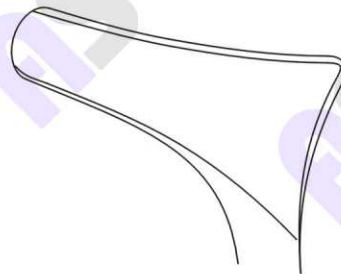

37-3030-16

Fig. 1

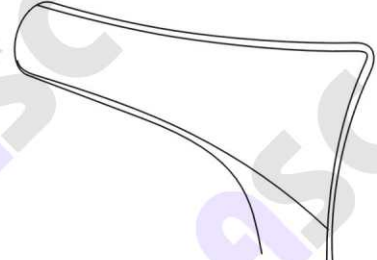

37-3031-16

Fig. 2

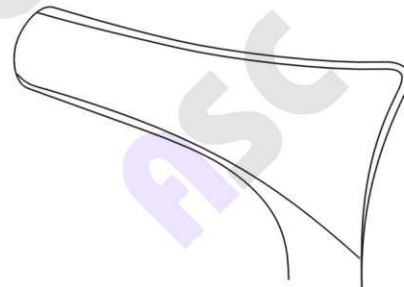

37-3032-16

Fig. 3



Hartmann-Halle
15 cm / 6"

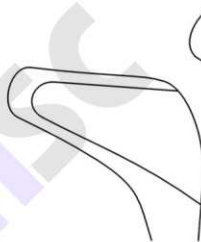

37-3035-15

Fig. 1

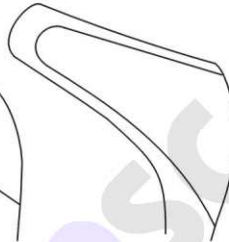

37-3036-15

Fig. 2

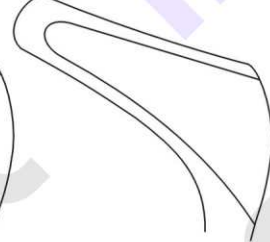

37-3037-15

Fig. 3

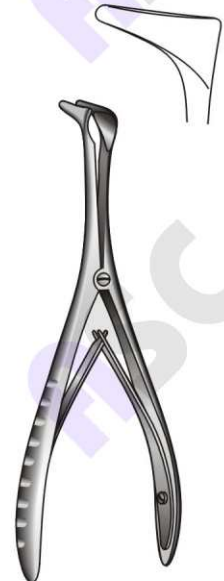

37-3040-13

13 cm / 5"

Nasal Specula
Nasenspekula
Espéculos nasales

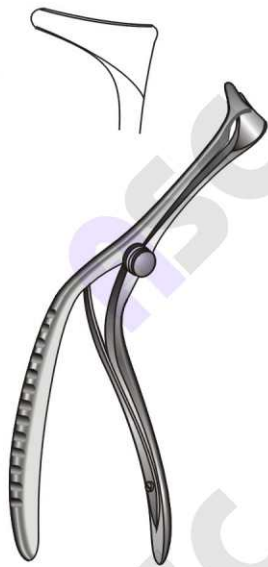

37-3045-13
13 cm / 5"



Tieck-Halle
13.5 cm / 5 1/4"



37-3050-13
Fig. 1



37-3051-13
Fig. 2



Beckman
37-3055-15
15 cm / 6"



Vienna
37-3060-14 Infant
37-3061-14 Child
37-3062-14 Adult
37-3063-14 Sheet
37-3064-14 Metal
14.5 cm / 5 1/2"

Nasal Specula
Nasenspekula
Especulos nasales



Killian
13 cm / 5"

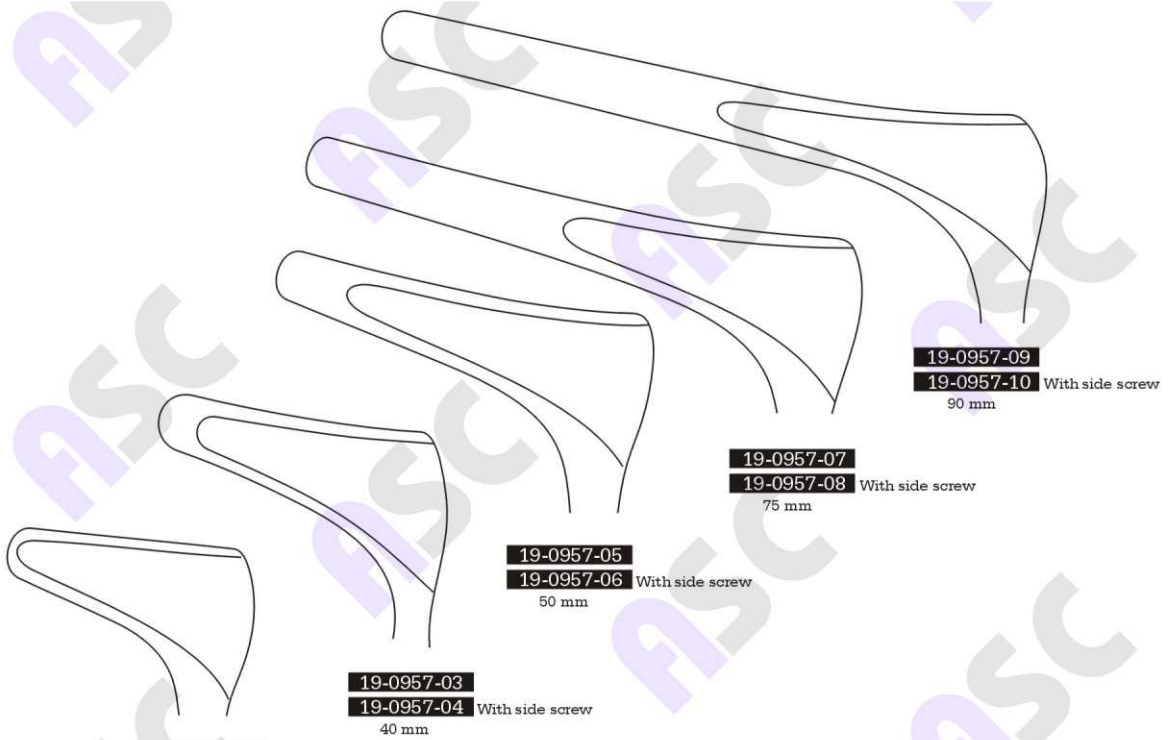

19-0957-01
19-0957-02 With side screw
35 mm

19-0957-05
19-0957-06 With side screw
50 mm

19-0957-03
19-0957-04 With side screw
40 mm

19-0957-07
19-0957-08 With side screw
75 mm

19-0957-09
19-0957-10 With side screw
90 mm



Cottle
14 cm / 5½"
Extra thin blades

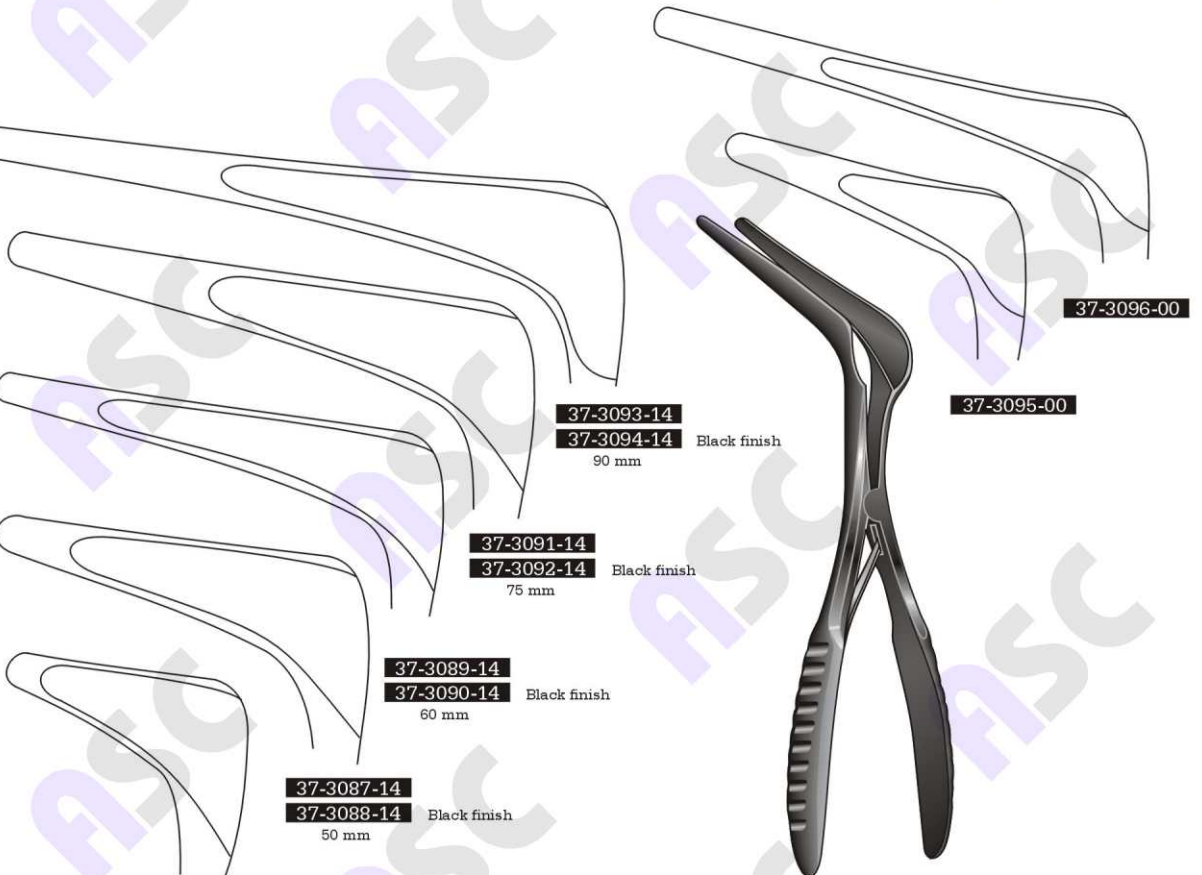

37-3085-14
37-3086-14 Black finish
35 mm

37-3089-14
37-3090-14 Black finish
60 mm

37-3091-14
37-3092-14 Black finish
75 mm

37-3093-14
37-3094-14 Black finish
90 mm

37-3095-00

37-3096-00

Dull black chrome plated

Nasal Specula
Nasenspekula
Especulos nasales



Tessler
17 cm / 6¾"
For dilation, black chromium plated

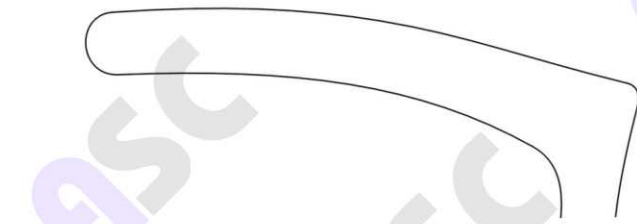

37-3101-17
70 x 8.5 mm blade
For adults

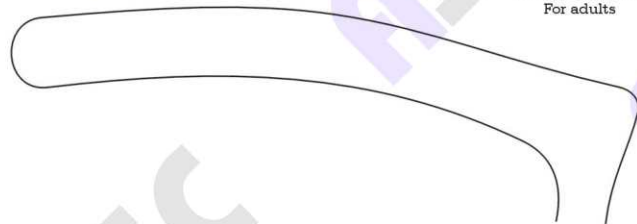

37-3102-17
80 x 8.5 mm blade
For adults

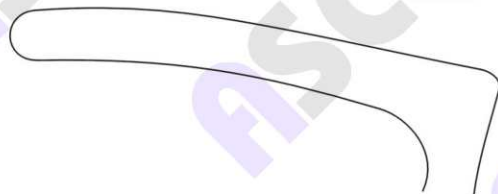

37-3103-17
60 x 7.0 mm blade
For children

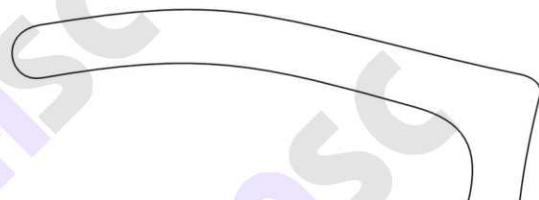

37-3104-17
70 x 7.0 mm blade
For children

Polypus Snares
Polypenschnürer
Cierranudos para pólipos

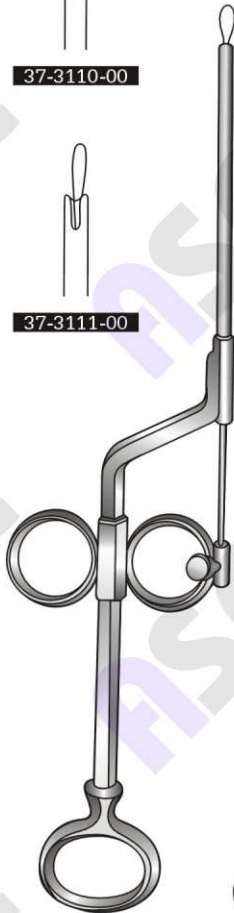
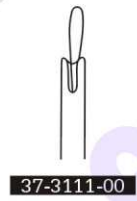

Glegg

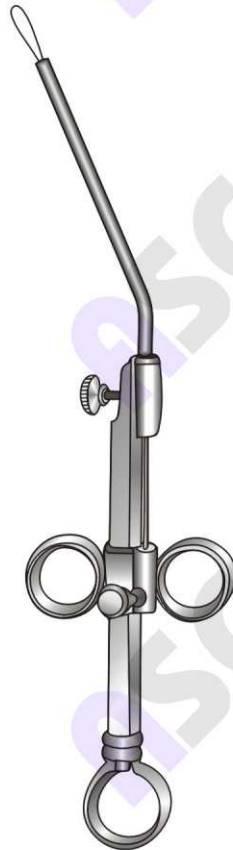

Krause
37-3113-00



Krause
37-3115-26
26 cm / 10¼"
3 mmØ

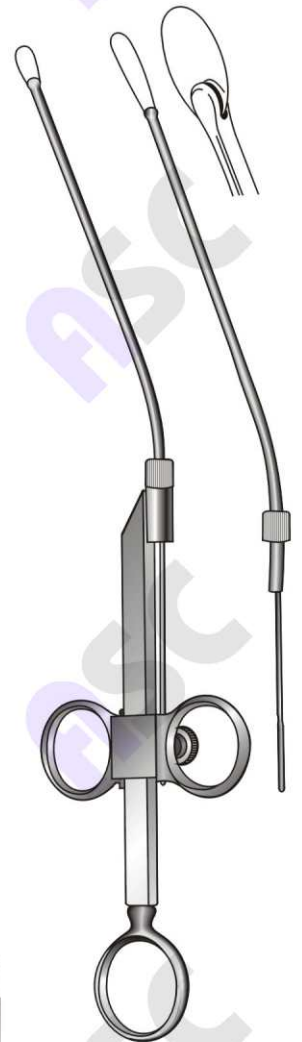

Krause-Voss
37-3120-26
26 cm / 10¼"
3 mmØ



Krause
37-3125-00
Open tip

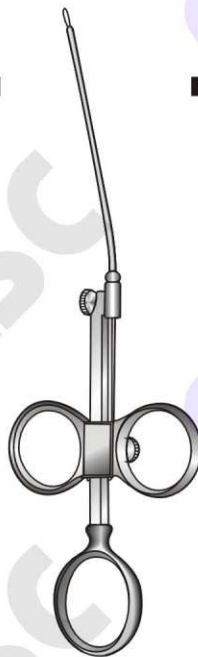

Krause-Voss
37-3130-00
Closed tip

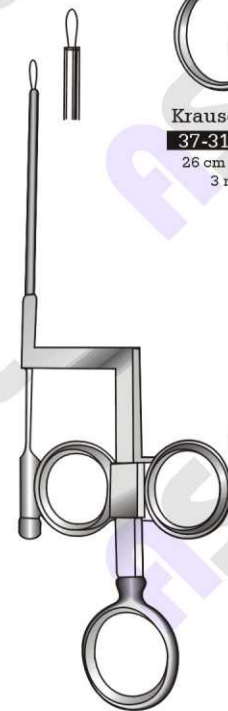

Lange-Wilde
37-3135-25
25.5 cm / 10"
Bayonet shaped

Ear Forceps, Nasal Tampon Forceps
Ohrpinzetten, Nasentamponpinzetten
Pinzas auriculares, Pinzas para tamponamiento

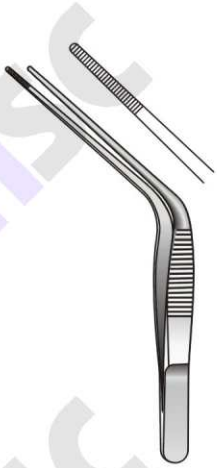

Troeltsch (wilde)
37-3140-11
11 cm / 4½"



Troeltsch (wilde)
37-3145-12
12 cm / 4¾"

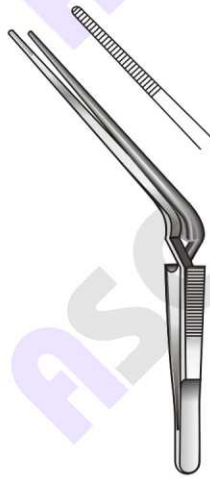

Troeltsch (wilde)
37-3150-13
13 cm / 5"



Lucae
37-3155-14
37-3156-14 1:2 Teeth
14 cm / 5½"



Jansen
37-3160-16 16 cm / 6¼"
37-3160-20 20 cm / 8"



37-3165-00 0.3 mm Ø
37-3166-00 0.4 mm Ø
Snare wire



Troeltsch
37-3175-15
15 cm / 6"



Troeltsch
37-3180-18
18 cm / 7"



Gruenwald (Jansen)
37-3185-16 16 cm / 6¼"
37-3185-20 20 cm / 8"



37-3170-10 0.2 mm Ø
37-3171-10 0.3 mm Ø
10.5 cm / 4"
Snare wire
12 pieces

Nasal Polypus, Septum Compression Forceps
Polypenzangen, Septumzange
Pinzas para pólipos, Pinza para el tabique nasal

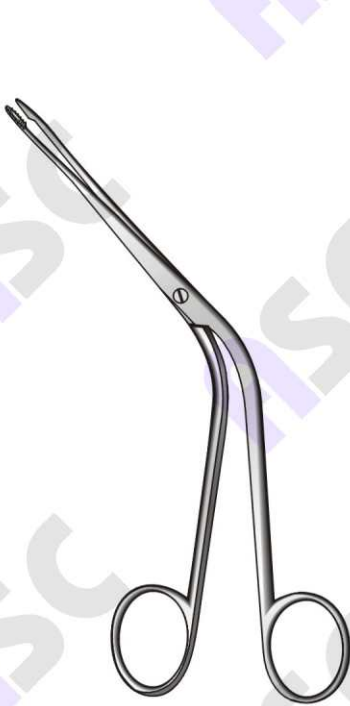

Hartmann
37-3190-16
16 cm / 6¼"

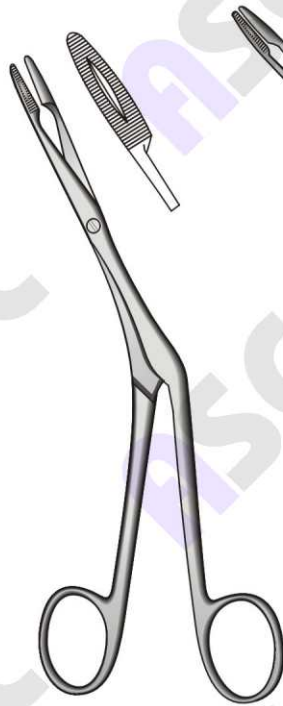

Heymann-Knight
37-3195-18
18 cm / 7"



Hartmann
37-3201-20
20 cm / 8"

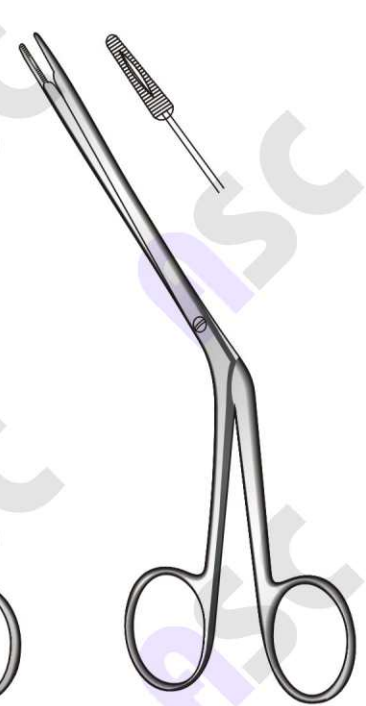

Littauer
37-3205-18
18 cm / 7"



Killian
37-3210-17
17 cm / 6¾"



Westmacott
37-3215-20
20 cm / 8"



Lubet-Barbon
37-3220-20
20 cm / 8"
Nasal tampon forceps



Heymann
18 cm / 7"



37-3225-18 **37-3226-18**

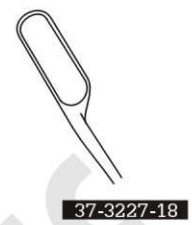

37-3227-18

Septum Forceps, Ethmoid Bone Forceps
Septumzangen, Siebbeinzangen
Pinzas para tabique nasal, Pinzas para ethmoides

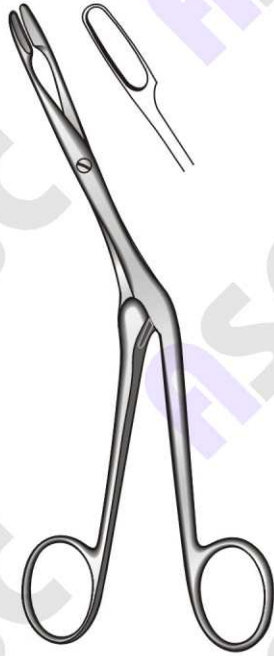

Knight
37-3230-18
18 cm / 7"

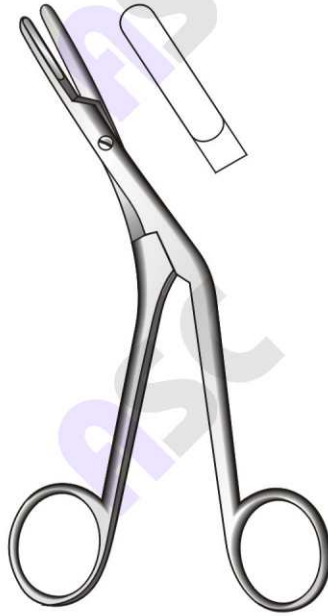

Graig
37-3235-18
18 cm / 7"



37-3240-18 Curved to left
37-3241-18 Curved to right

18 cm / 7"



37-3245-20 Fig. 1
37-3246-20 Fig. 2



Luc
20 cm / 8"

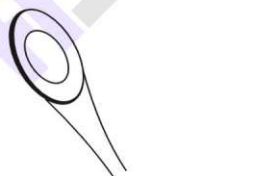

37-3250-20 Fig. 1



Luc
20 cm / 8"



37-3255-19 Fig. 1
37-3256-19 Fig. 2

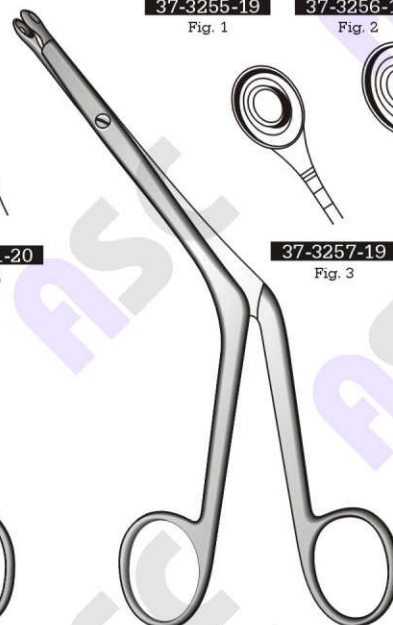

Bruenings
19 cm / 7½"



37-3257-19 Fig. 3
37-3258-19 Fig. 4

Ethmoid Bone Forceps, Nasal Cutting Forceps
Siebbeinzangen, Scharfe Nasenzangen
Pinzas para etmoides, Pinzas nasal cortantes



Watson-Williams
37-3266-19

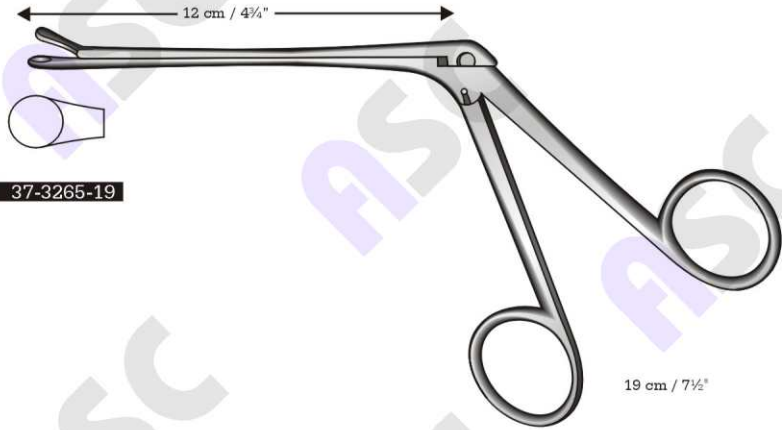

37-3265-19

19 cm / 7 1/2"

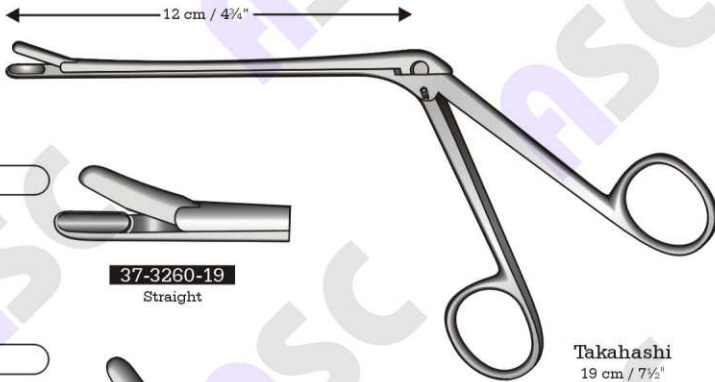

37-3260-19
Straight

Takahashi
19 cm / 7 1/2"



37-3261-19
Upward



Henckel
37-3270-20
20 cm / 8"

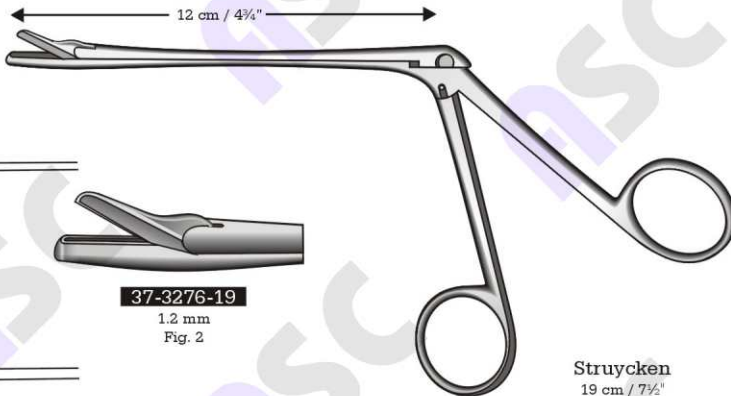

Struycken
19 cm / 7 1/2"



37-3276-19
1.2 mm
Fig. 2



37-3275-19
0.9 mm
Fig. 1

Nasal Cutting Forceps, Ethmoid Bone Forceps
 Scharfe Nasenzangen, Siebbeinzangen
 Pinzas nasal cortantes, Pinzas para etmoides

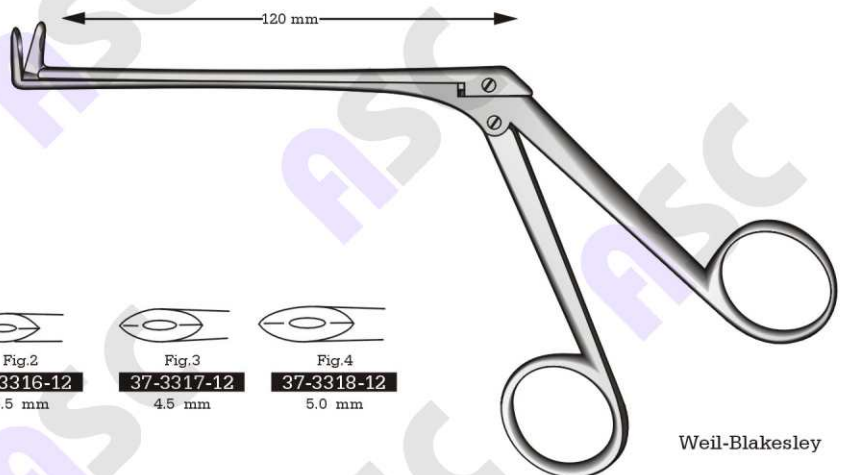
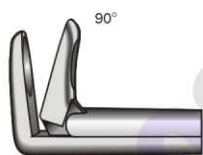
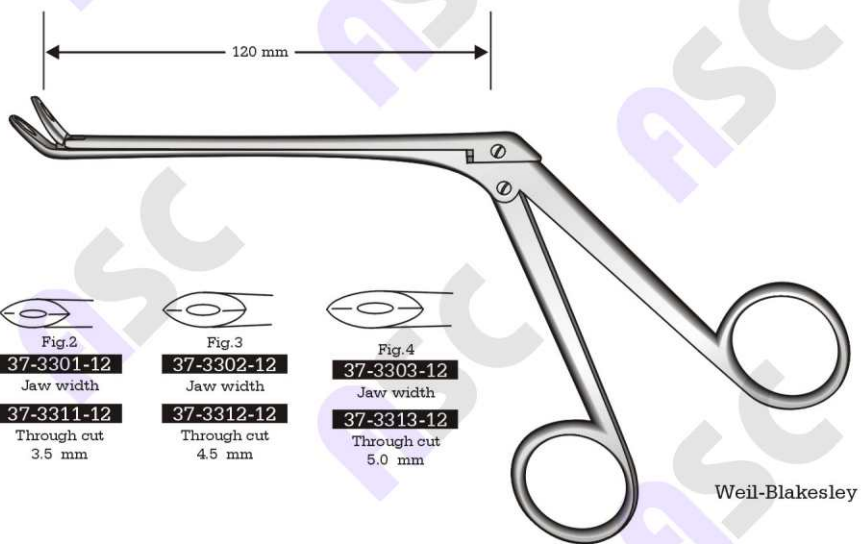
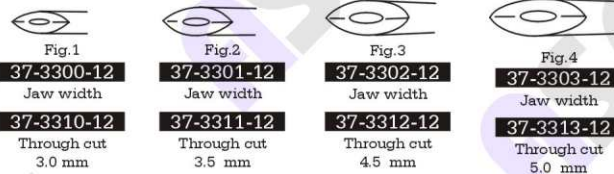
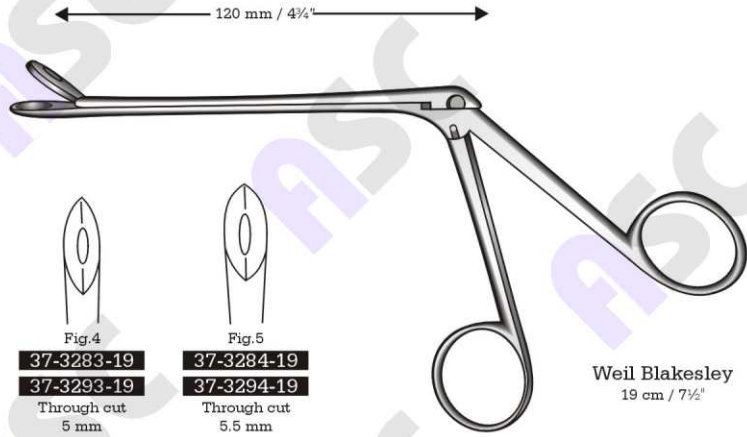
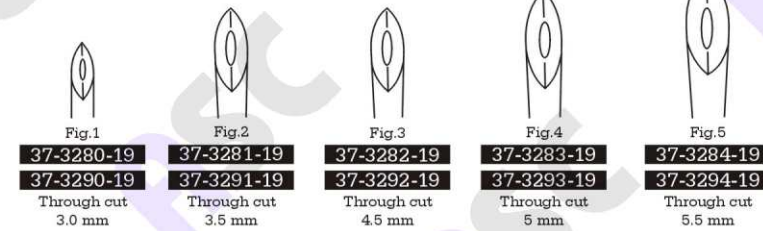
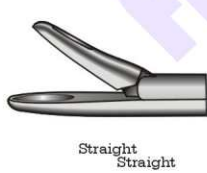

Nasal Cutting Forceps
Scharfe Nasenzangen
Pinzas nasal cortantes

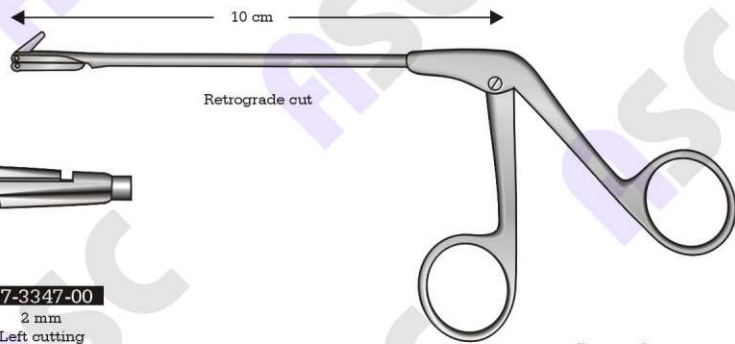
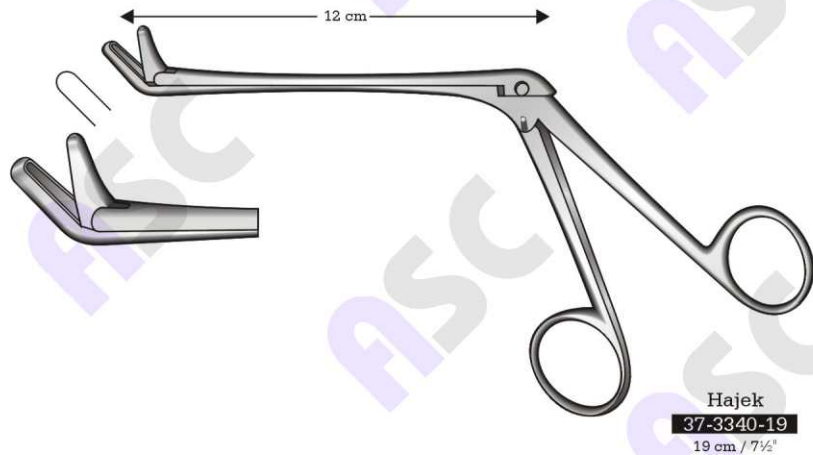
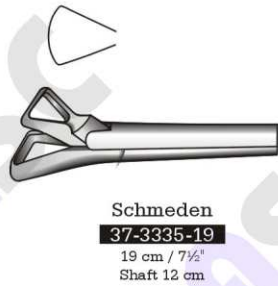
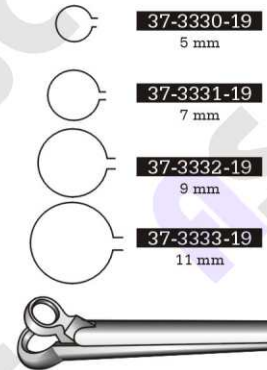
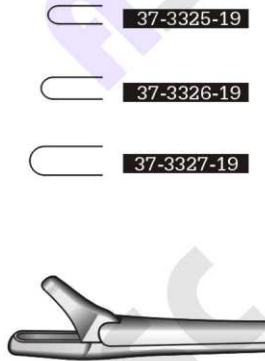
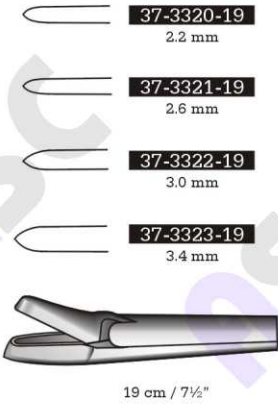

Septum Forceps, Septum Scissors
Septumzangen, Septumscheren
Pinzas y tijeras para tabique nasal



Jansen-Struycken
37-3350-19
19 cm / 7½"



Middleton-Jansen
37-3355-19
19 cm / 7½"

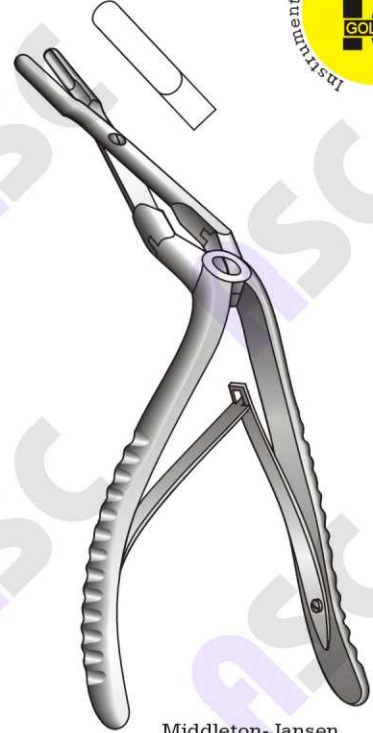

Middleton-Jansen
37-3360-19
19 cm / 7½"

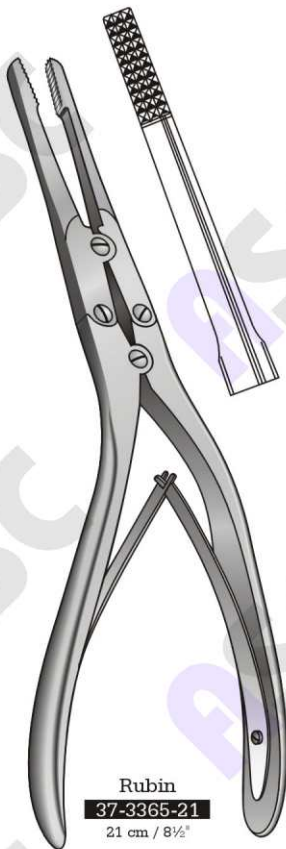

Rubin
37-3365-21
21 cm / 8½"

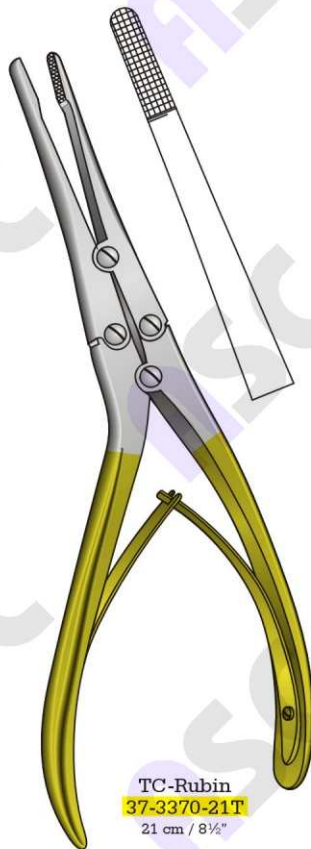

TC-Rubin
37-3370-21T
21 cm / 8½"

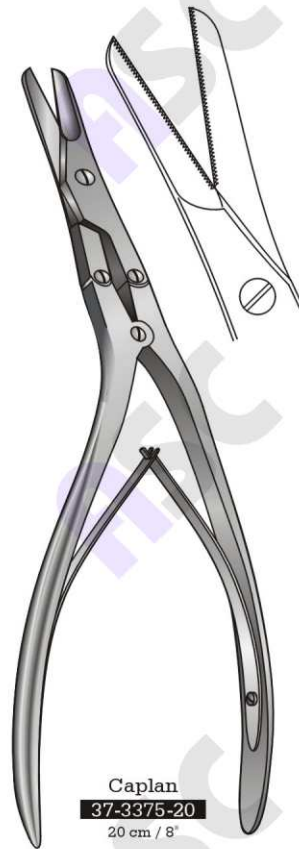

Caplan
37-3375-20
20 cm / 8"

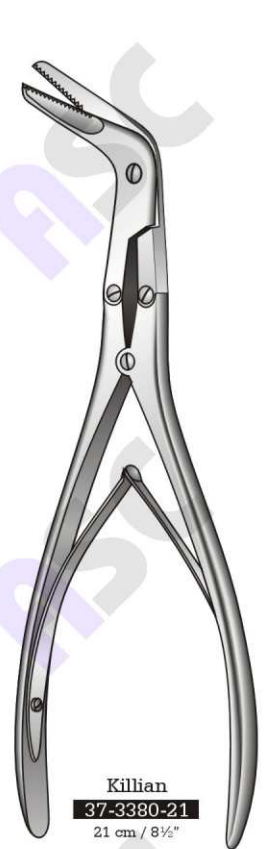

Killian
37-3380-21
21 cm / 8½"

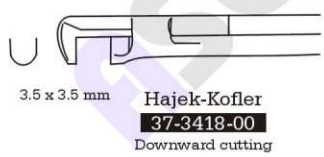
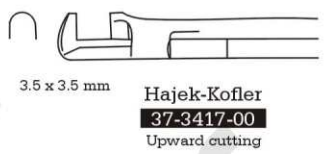

Rongeur Forceps, Antrum Punches Forceps
Meißelzangen, Kieferhöhlenstanzen
Pinzas gubias, Pinzas sacabocados para seno maxilar

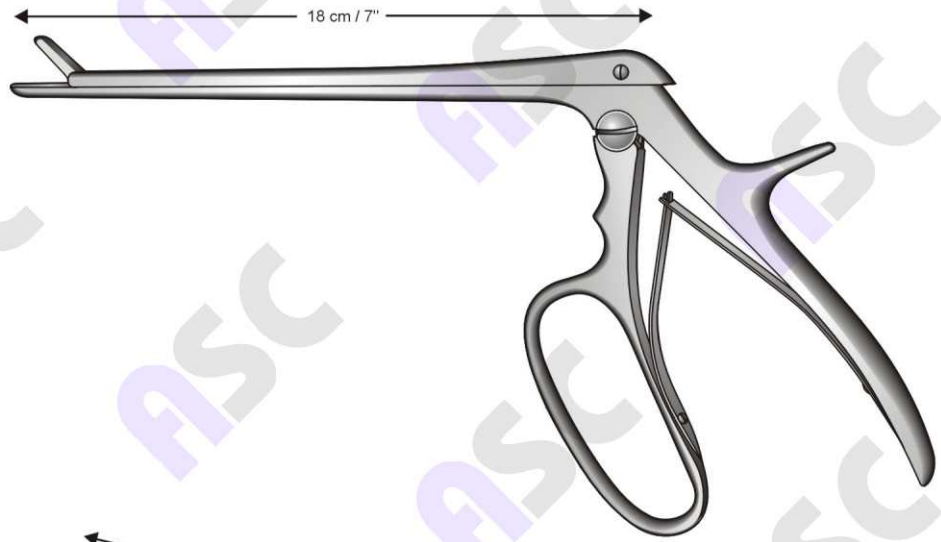
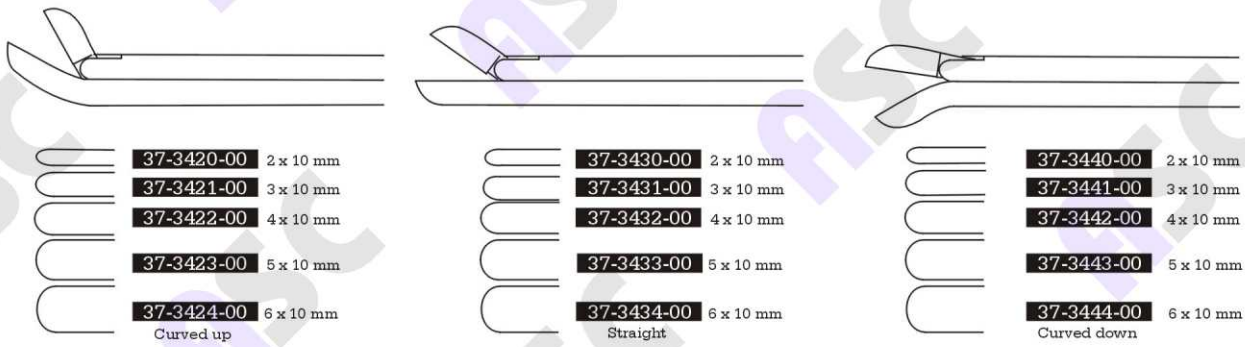

Ferris-Smith-Cushing



Kerrison
20 cm / 8"
Up cutting

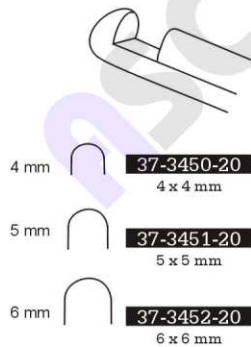

Rhinoplastic and Nasal Knives
Nasenplastik und Operationsmesser
Bisturías para plastica y operaciones de la nariz

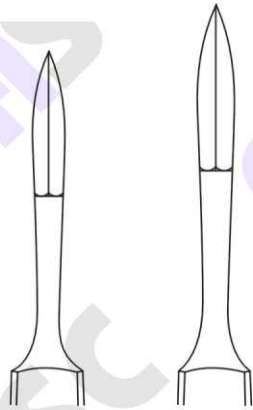

37-3455-15

Straight
Fig. 1

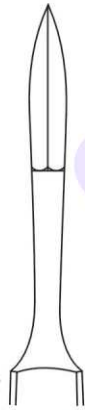

37-3456-15

Straight
Fig. 2



37-3460-15

Straight
Fig. 1



37-3461-15

Straight
Fig. 2



Joseph
15 cm / 6"
Sharp

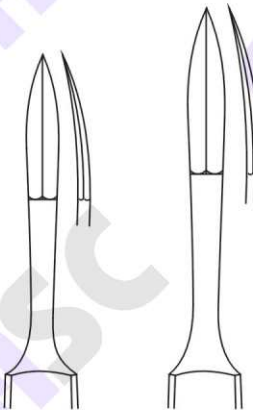

37-3457-15

Curved
Fig. 3



37-3458-15

Curved
Fig. 4



37-3462-15

Curved
Fig. 3



37-3463-15

Curved
Fig. 4



Joseph
15 cm / 6"
Blunt



Heymann
37-3465-00



Krieg
37-3470-00



Joseph
37-3475-15
15 cm / 6"
Straight



Cottle
37-3480-00

Rhinoplastic and Nasal Knives
Nasenplastik und Operationsmesser
Bisturías para plastica y operaciones de la nariz



Ballenger
37-3485-00



Freer
37-3490-00



Freer
37-3495-00
Mucosa knife

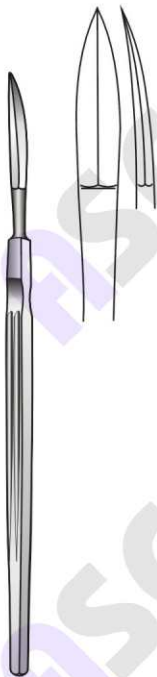

Fomon
37-3501-16
16.5 cm / 6½"



Converse
37-3505-16
16 cm / 6¼"
Curved blade 4 x 35 mm,
with button end bistouri



Cottle
37-3510-14
14 cm / 5½"

Septum Knives, Septum Elevators, Raspatories
Septummesser, Septum-Elevatorien, Raspatorien
Bisturías y elevadores para el tabique nasal, Legras



Freer
37-3515-00



Freer
37-3520-00



Freer
37-3525-19
19 cm / 7½"



Freer
37-3530-19
19 cm / 7½"



Freer
37-3535-19
19 cm / 7½"
Sharp
5 mm



Freer
37-3540-19
19 cm / 7½"
Blunt
6 mm

Septum Knives, Septum Elevators, Raspatories
Septummesser, Septum-Elevatorien, Raspatorien
Bisturías y elevadores para el tabique nasal, Legras



Freer
37-3545-16 16 cm / 6¼"
37-3545-19 19 cm / 7½"
Sharp / Blunt
5/5 mm



Durham
37-3550-00



Howarth
37-3560-00

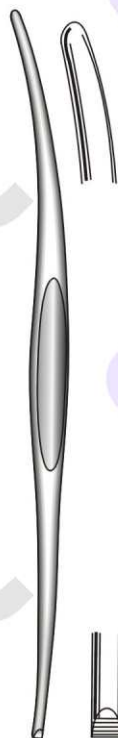

Hill
37-3565-00



Freer
37-3570-18 19.5 cm / 7¾"
37-3570-22 22 cm / 8¾"
Blunt / Sharp
Square handle



Hurd
39-3001-21
21 cm / 8¼"
For right hand



Hurd
39-3005-21
21 cm / 8¼"
For left hand



Durham
39-3010-25
25 cm / 10"



Durham
39-3015-25
25 cm / 10"



Dupuy-Weiss
39-3020-22
22 cm / 8¾"



Dupuy-Weiss
39-3025-22
22 cm / 8¾"

Tonsil Knives
Tonsillenmesser
Bisturías para amígdalas



Douglas
39-3030-21
21 cm / 8 1/4"



Colver
39-3035-22
22.5 cm / 9"



Fisher
39-3040-22
22.5 cm / 9"



Day
39-3045-21
21.5 cm / 8 1/2"



Abraham
39-3050-21
21.5 cm / 8 1/2"



Canfield
39-3055-21
21 cm / 8 1/4"



Tyding
39-3060-21
21 cm / 8 1/4"



Lynch
39-3065-20
20 cm / 8"

Tonsil Knives, Dissectors, Enucleator, Packer Retractors
Tonsillennmesser, Dissektoren, Enukleatoren, Retraktoren
Bisturías, Discadores, Enucleadores, Separadores

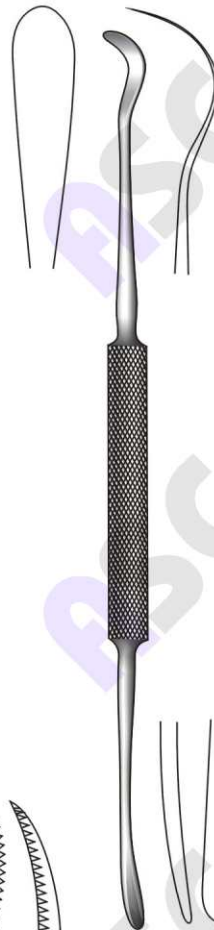

Carpenter
39-3070-22
22.5 cm / 9"
4.4/8.8 mm

Carpenter
39-3075-22
22.5 cm / 9"
4.4/8.8 mm



Hurd
39-3080-23
23 cm / 9"
11/14 mm

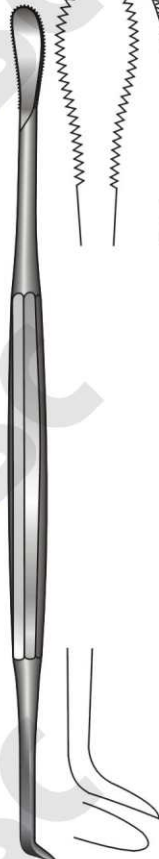

Henke
39-3085-23
23 cm / 9"
10.5/5 mm



Henke
39-3090-23
23 cm / 9"
16/5 mm

Dissectors, Retractors, Gauze Packers
Dissektoren, Wundhaken, Tamponstopfer
Discadores, Separadores, Taponeadores

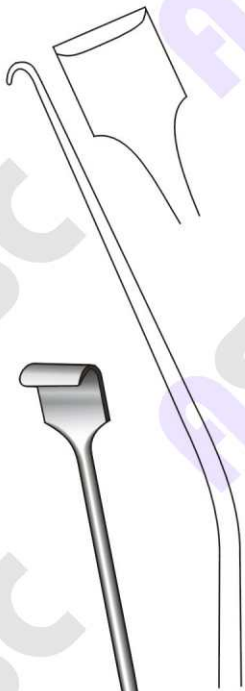

Nager
39-3095-24
24 cm / 9½"

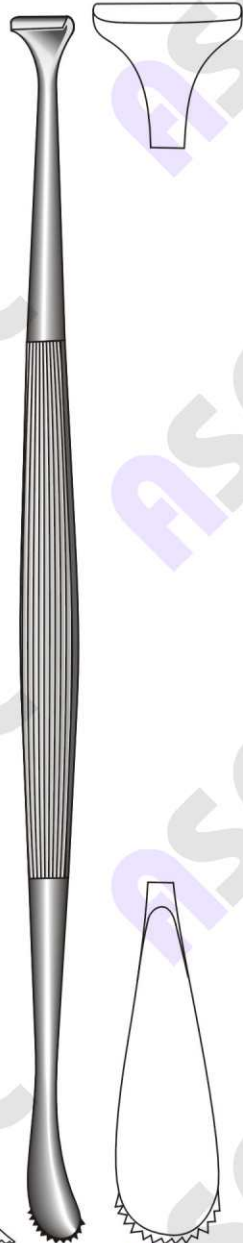

Hurd
39-3101-22
22 cm / 8½"
10 x 12 mm wide
Throat retractors and dissector



Luniatschek
17.5 cm / 7"



39-3105-17
2 mm



39-3106-17
3 mm



39-3110-17
2 mm
Round handle



Luniatschek
17.5 cm / 7"

Tonsil Forceps
Tonsillenklemmen, Abszesszangen
Pinzas hemostáticas, Lanceta para abscesos

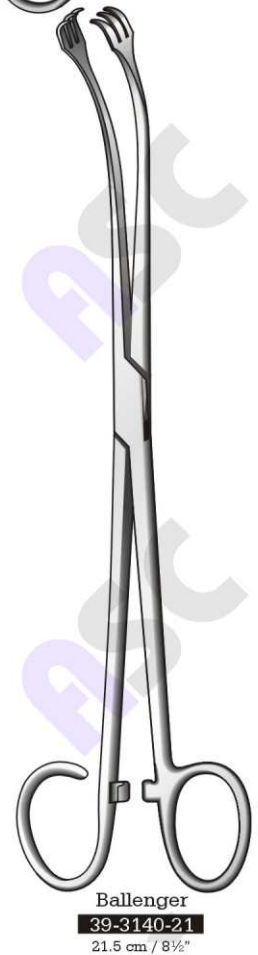
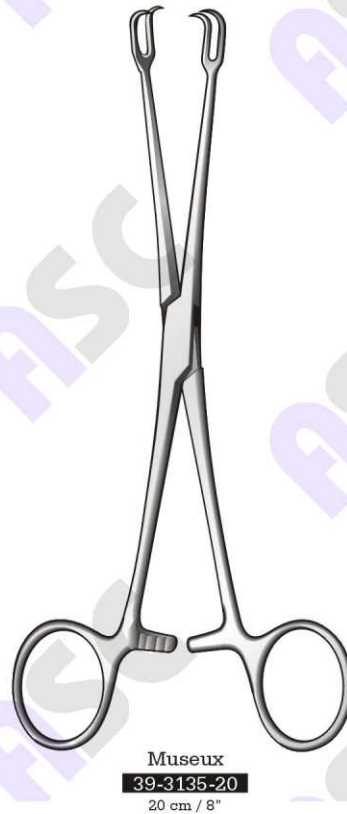
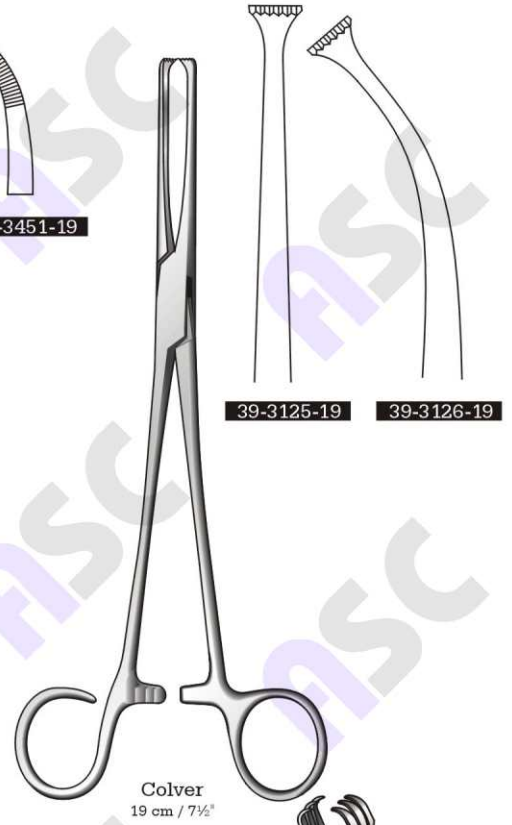
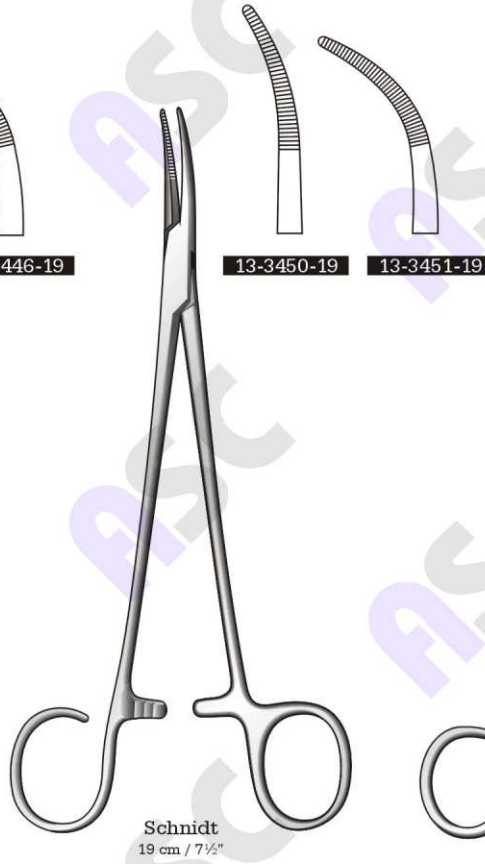
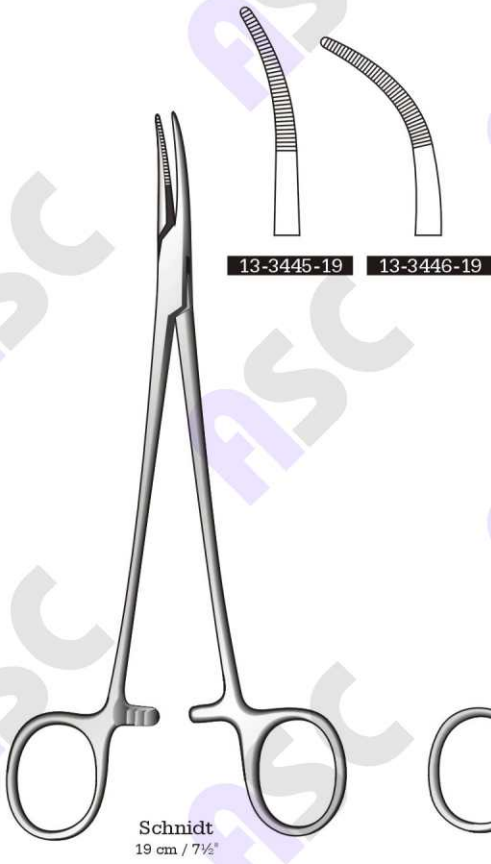

Tonsil Seizing Forceps
Tonsillenzangen
Pinzas para coger las amígdalas

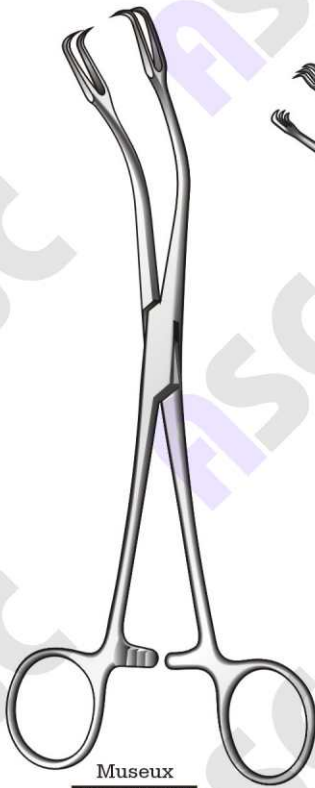

Museux
39-3145-20
20 cm / 8"

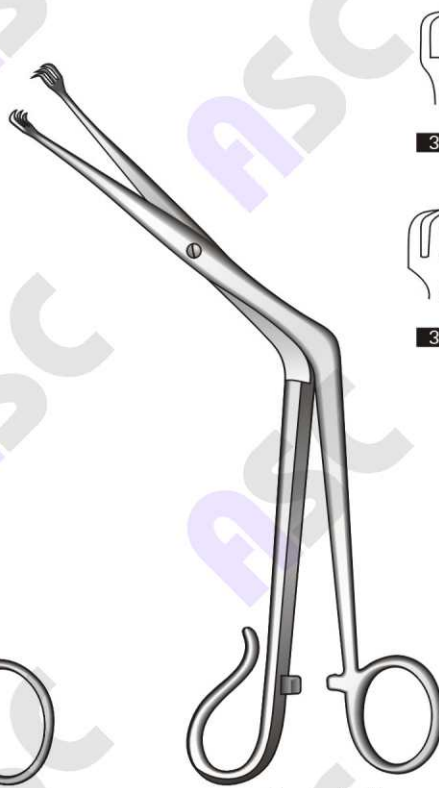

Tivnen-Tyding
21 cm / 8 1/4"

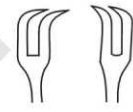

39-3150-21

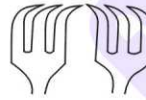

39-3151-21

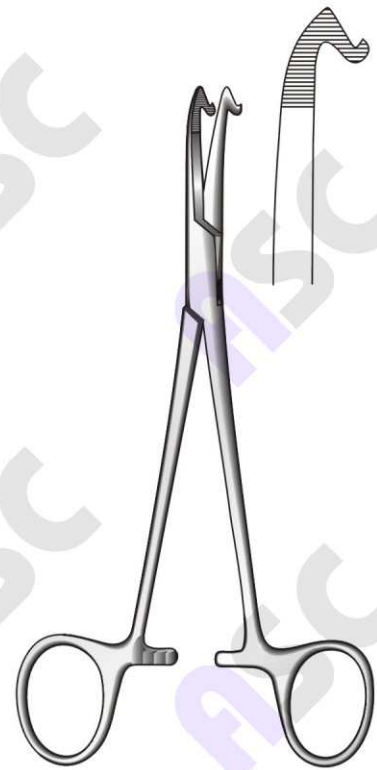

McWhofter-Lothrop
39-3155-18
18 cm / 7"



Blohmke
39-3160-20
20 cm / 8"

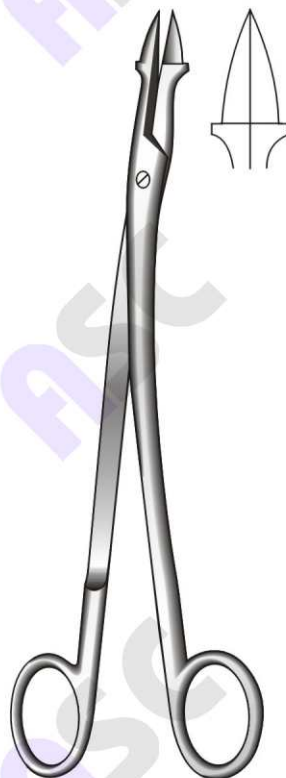

Thilenius
39-3165-20
20 cm / 8"

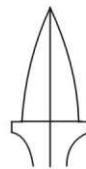

Denis-Browne
39-3170-18
18 cm / 7"



Tonsil Snares
Tonsillenschnürer
Cierranudos para amígdalas



Eves
39-3180-28
28 cm / 11"



Eves
39-3185-28
28 cm / 11"



Bruenings
39-3190-28
28 cm / 11"



39-3175-00
0.3 mm Ø

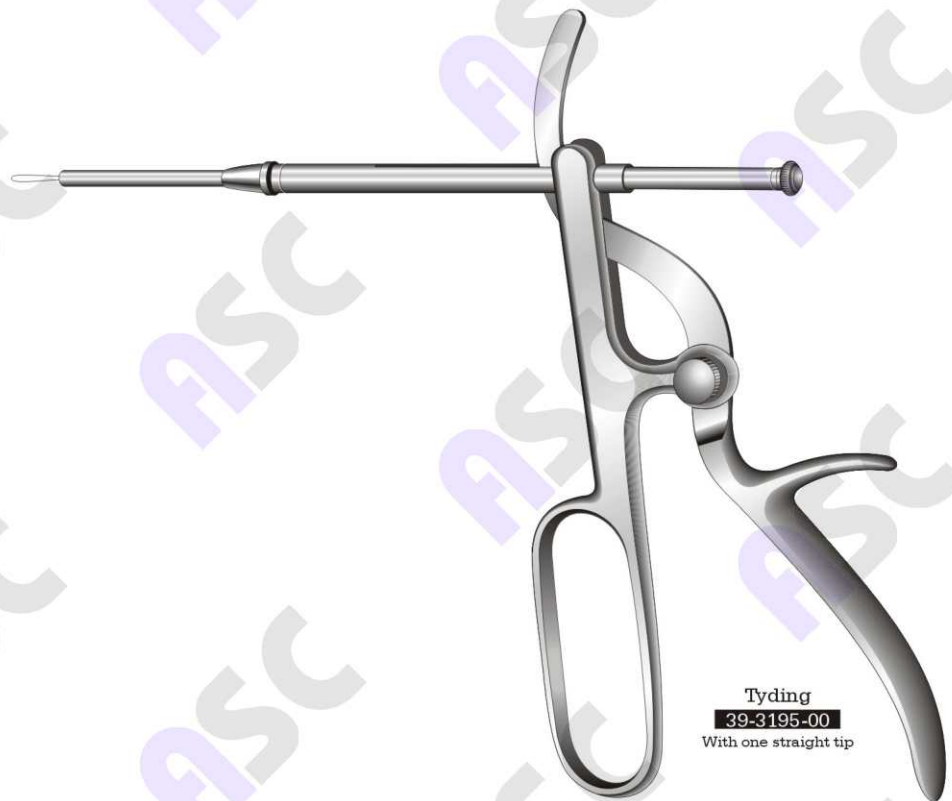

Tyding
39-3195-00
With one straight tip

Bone Holding Forceps
Knochenhaltezangen
Pinzas para huesos

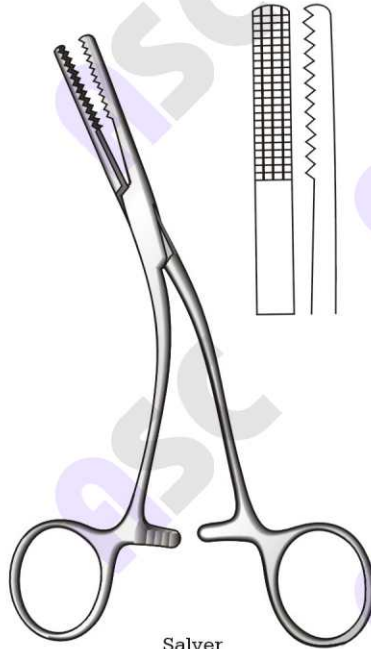
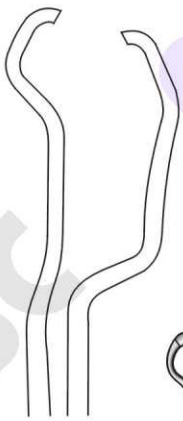

Salyer
39-3201-16
16 cm / 6½"

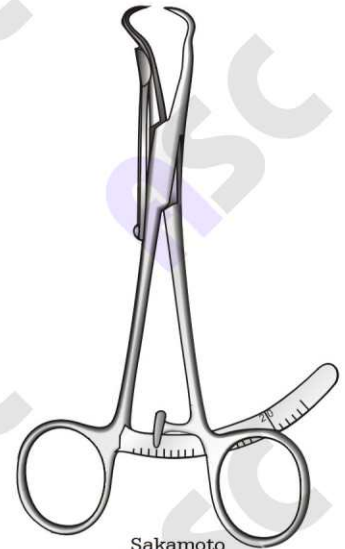

Sakamoto
39-3205-14
14 cm / 5½"
Measuring forceps

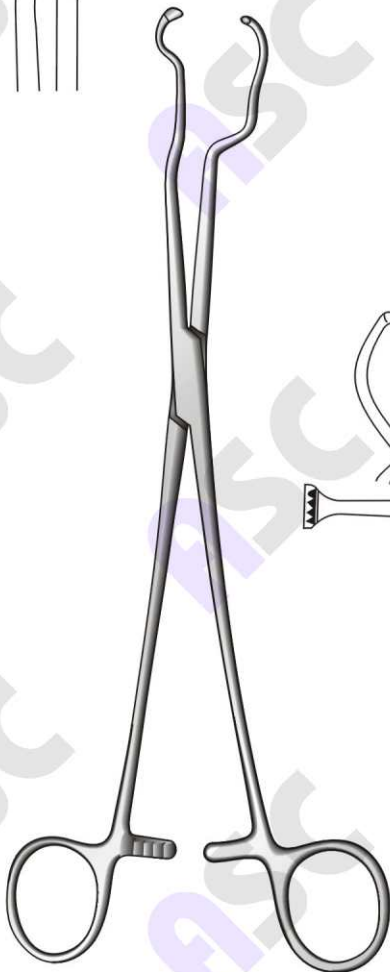

Wolford
39-3210-25
25 cm / 10"

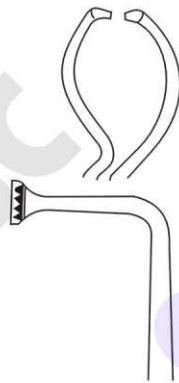

39-3215-17
Left

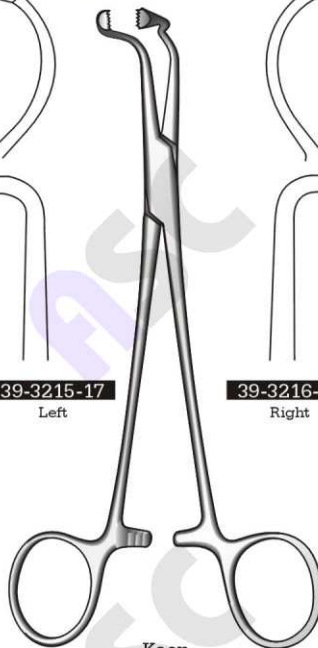

Keen
17.5 cm / 6¾"

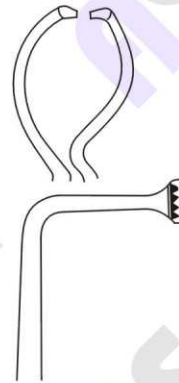

39-3216-17
Right





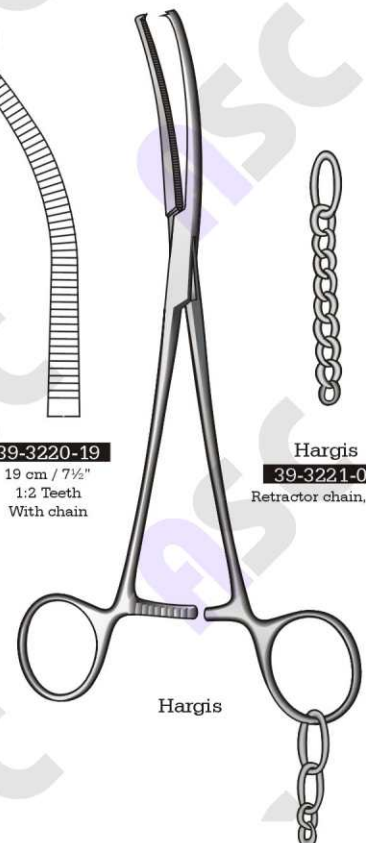

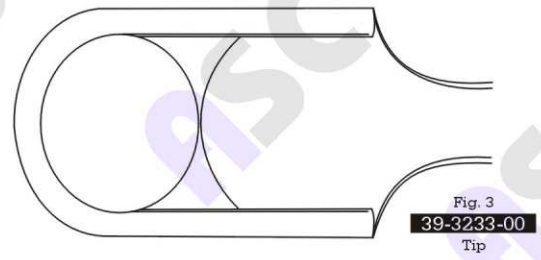
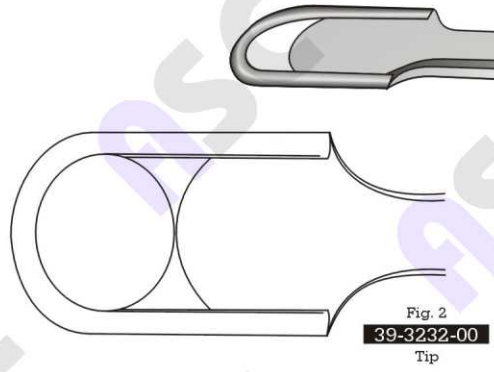
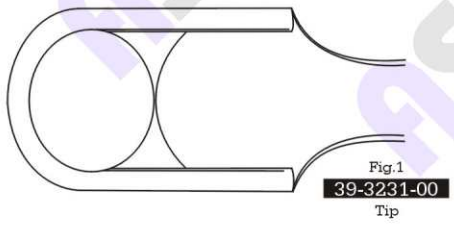
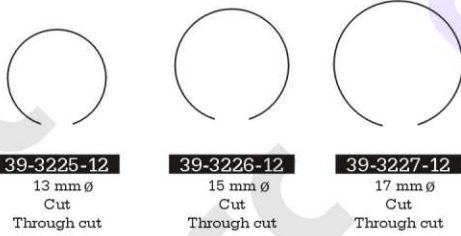

39-3220-19
19 cm / 7½"
1:2 Teeth
With chain



Hargis
39-3221-00
Retractor chain, only



Broncho-Esophagoscopy Forceps
Broncho-Esophagoskopiezangen
Pinzas para bronco-esofagoscopia

Shaft length							
30 cm / 12"	39-4001-30	39-4002-30	39-4003-30	39-4004-30	39-4005-30	39-4006-30	39-4007-30
40 cm / 16"	39-4001-40	39-4002-40	39-4003-40	39-4004-40	39-4005-40	39-4006-40	39-4007-40
50 cm / 20"	39-4001-50	39-4002-50	39-4003-50	39-4004-50	39-4005-50	39-4006-50	39-4007-50
60 cm / 24"	39-4001-60	39-4002-60	39-4003-60	39-4004-60	39-4005-60	39-4006-60	39-4007-60

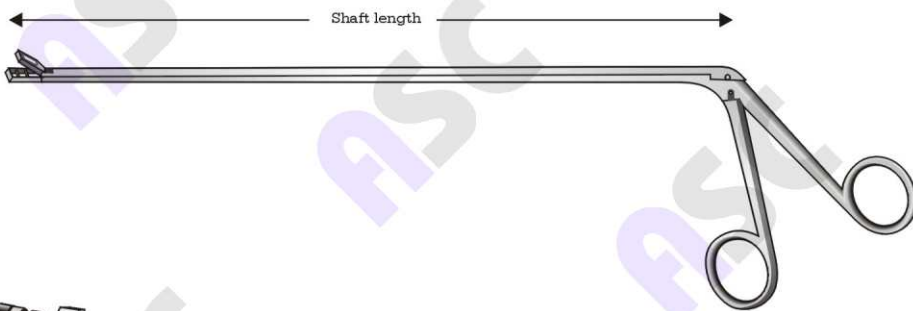

Chevalier-Jackson



Bruenings

39-4015-20	20 cm / 8"
39-4015-30	30 cm / 12"
39-4015-40	40 cm / 16"
39-4015-50	50 cm / 20"
39-4015-60	60 cm / 24"

Interchangeable tubes



Bruenings
39-4020-20
20 cm / 8"
Interchangeable tube

Exchangeable Tips
Auswechselbare Zangenaufsätze
Pinzas intercambiables



Fraenkel
39-4025-00



Baracani
39-4030-00



Seiffert
39-4035-00



Fraenkel
39-4040-00



Scheinmann
39-4045-00



Scheinmann
39-4050-00



39-4055-00

39-4056-00

Bruenings



39-4060-00

39-4061-00

Bruenings



Lange
39-4065-00



39-4070-00

39-4071-00

Krause



Krause
39-4075-00



39-4080-00

39-4081-00

39-4082-00

39-4083-00

Cordes



Schumacher
39-4085-00
With drawing cut



39-4090-00

39-4091-00

Cordes



Cordes
39-4095-00



Rosenberg
39-4101-00

Laryngeal Mirrors, Handles
Kehlkopfspiegel und -griffe
Espejos laringeos, Mangos

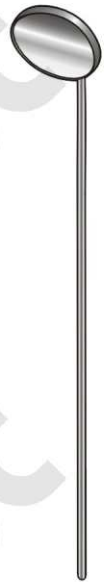

13.5 cm / 5 1/4"
Plane, without handle

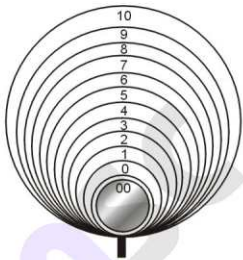

- 39-4105-00** Fig. 00 = 8 mm Ø
- 39-4106-00** Fig. 0 = 10 mm Ø
- 39-4107-00** Fig. 1 = 12 mm Ø
- 39-4108-00** Fig. 2 = 14 mm Ø
- 39-4109-00** Fig. 3 = 16 mm Ø
- 39-4110-00** Fig. 4 = 18 mm Ø
- 39-4111-00** Fig. 5 = 20 mm Ø
- 39-4112-00** Fig. 6 = 22 mm Ø
- 39-4113-00** Fig. 7 = 24 mm Ø
- 39-4114-00** Fig. 8 = 26 mm Ø
- 39-4115-00** Fig. 9 = 28 mm Ø
- 39-4116-00** Fig. 10 = 30 mm Ø

Mirror without handle

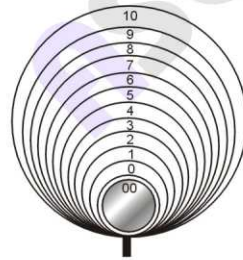

- 39-4120-00** Fig. 00 = 8 mm Ø
- 39-4121-00** Fig. 0 = 10 mm Ø
- 39-4122-00** Fig. 1 = 12 mm Ø
- 39-4123-00** Fig. 2 = 14 mm Ø
- 39-4124-00** Fig. 3 = 16 mm Ø
- 39-4125-00** Fig. 4 = 18 mm Ø
- 39-4126-00** Fig. 5 = 20 mm Ø
- 39-4127-00** Fig. 6 = 22 mm Ø
- 39-4128-00** Fig. 7 = 24 mm Ø
- 39-4129-00** Fig. 8 = 26 mm Ø
- 39-4130-00** Fig. 9 = 28 mm Ø
- 39-4131-00** Fig. 10 = 30 mm Ø

Mirror with handle



18.5 cm / 7 1/4"
Plane, with fixed handle
Rhodium handle



39-4135-00
10 cm / 4"



39-4140-00
10 cm / 4"



Michel
25 cm / 10"
Moveable mirror



39-4145-25
12 mm Ø
Fig. 1



39-4146-25
14 mm Ø
Fig. 2



39-4147-25
16 mm Ø
Fig. 3



39-4148-25
18 mm Ø
Fig. 4

Laryngeal Polypus Forceps, Epiglottis Retractor
Kehlkopfpolypenzangen, Kehldeckelhalter
Pinzas para pólipos laríngeos, Depresor de epiglótis



Kahler
39-4150-40
40 cm / 16"
Tip 4 mm



39-4155-30
30 cm / 12"
Tip 7 mm



Papilloma
39-4160-30
30 cm / 12"
Tip 7 mm



Jackson
30 cm / 12"
39-4165-30 2 mm
Straight
39-4166-30 4 mm
Curved



Jackson
39-4170-30
30 cm / 12", 4 mm
Angled



- 39-4175-12** 12 cm / 4 3/4", 2 mm
- 39-4175-14** 14 cm / 5 1/2", 2 mm
- 39-4175-16** 16 cm / 6 1/4", 2 mm
- 39-4175-18** 18 cm / 7", 3 mm
- 39-4175-20** 20 cm / 8", 3 mm
- 39-4175-30** 30 cm / 12", 4 mm
- 39-4175-40** 40 cm / 16", 4 mm
- 39-4175-50** 50 cm / 20", 4 mm

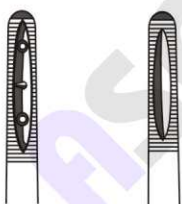

39-4180-24 1 x 2 Teeth
39-4181-24 Without teeth



Jackson
24 cm / 9 1/2"

Laryngeal Polypus Forceps
Kehlkopfpolypenzangen
Pinzas para pólipos laríngeos

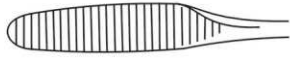

Fraenkel
39-4185-23
23 cm / 9"



39-4190-23



39-4191-23



39-4192-23



39-4193-23

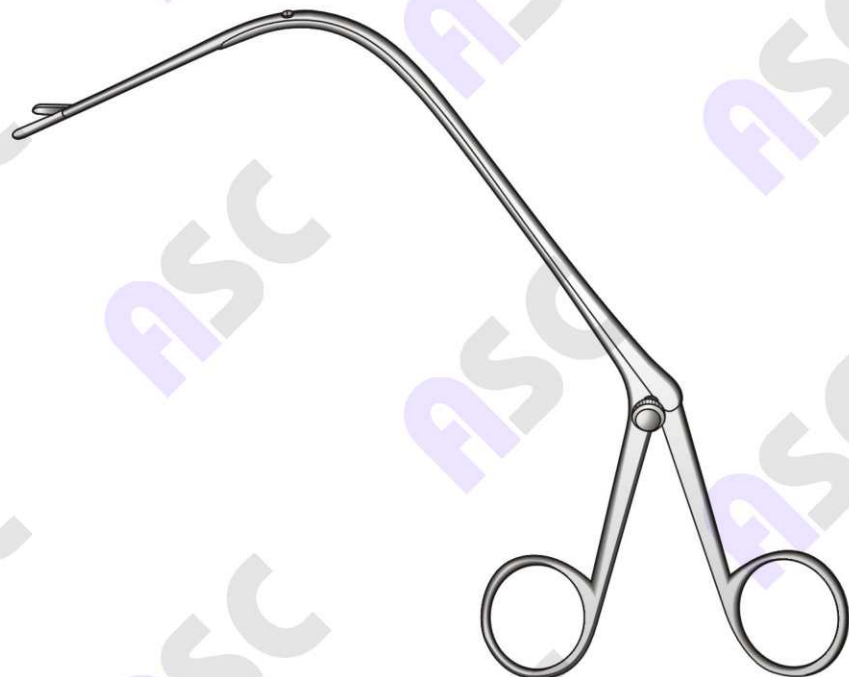

Jurasz
23 cm / 9"

Tracheotomy Trocars, Dilators, Retractors
Tracheal-Trokare und -dilatoren, Trachealhäkchen
Trócares y separadores para traqueotomía, Diladores



Uckermann
13 cm / 5"
Hollow handle

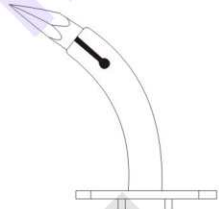

27-3001-13
8 mm



27-3002-13
10 mm

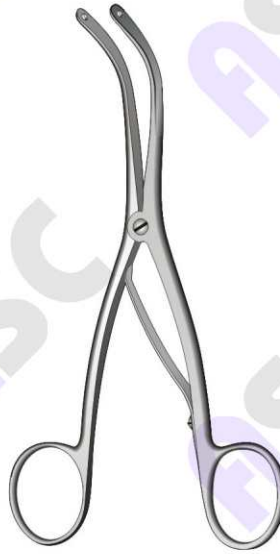

Trousseau
27-3005-14
14 cm / 5½"



Laborde
27-3010-14
14 cm / 5½"



Bose
27-3015-07
7 cm / 2¾"



27-3020-18
18 cm / 7"



27-3025-18
18 cm / 7"



Iterson
16 cm / 6¼"

27-3030-16
Sharp

27-3031-16
Blunt

Tracheal Retractors, Hooks
Tracheal Häkchen, Haken
Separadores para traqueotomía, Ganchos traqueales

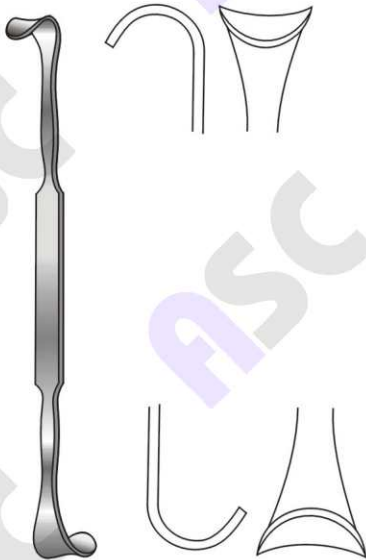

Rose
27-3035-13
13 cm / 5"

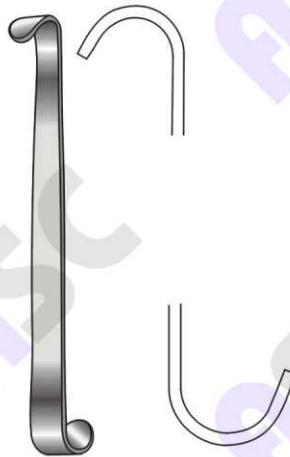

Luer
27-3040-11
11 cm / 4 1/4"



Jackson
27-3045-15
15 cm / 6"

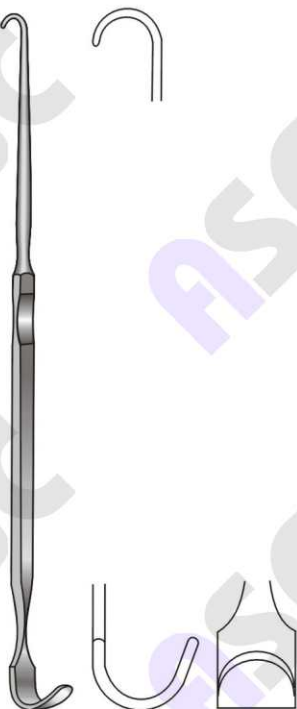

Jackson
27-3050-18
18 cm / 7"

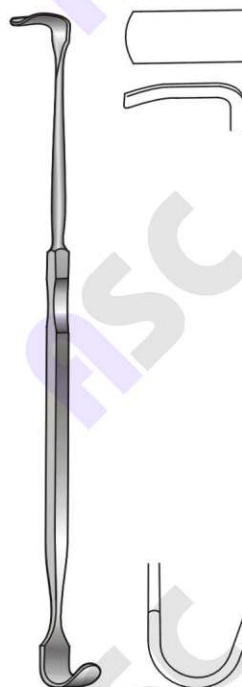

Lukens
27-3055-17
17 cm / 6 3/4"

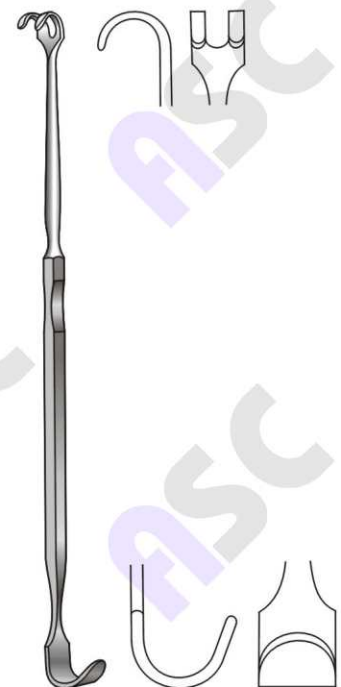

Jackson
27-3060-17
17 cm / 6 3/4"

International scale

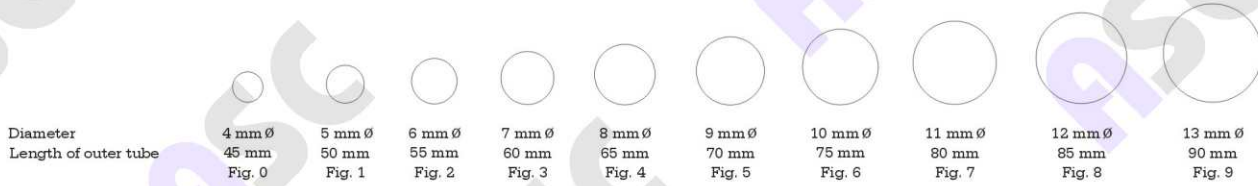

Chevalier-Jackson

Outer tube closed
Inner tube closed

Fig.	Ø
27-3065-00	0 4 mm
27-3066-00	1 5 mm
27-3067-00	2 6 mm
27-3068-00	3 7 mm
27-3069-00	4 8 mm
27-3070-00	5 9 mm
27-3071-00	6 10 mm
27-3072-00	7 11 mm
27-3073-00	8 12 mm
27-3074-00	9 13 mm



Luer

Outer tube sieve
Inner tube sieve

Fig.	Ø
27-3080-00	0 4 mm
27-3081-00	1 5 mm
27-3082-00	2 6 mm
27-3083-00	3 7 mm
27-3084-00	4 8 mm
27-3085-00	5 9 mm
27-3086-00	6 10 mm
27-3087-00	7 11 mm
27-3088-00	8 12 mm
27-3089-00	9 13 mm

Tracheal Tubes
Tracheal-Kanülen
Cánulas traqueales

International scale

Diameter	4 mm Ø	5 mm Ø	6 mm Ø	7 mm Ø	8 mm Ø	9 mm Ø	10 mm Ø	11 mm Ø	12 mm Ø	13 mm Ø
Length of outer tube	45 mm Fig. 0	50 mm Fig. 1	55 mm Fig. 2	60 mm Fig. 3	65 mm Fig. 4	70 mm Fig. 5	75 mm Fig. 6	80 mm Fig. 7	85 mm Fig. 8	90 mm Fig. 9



Krishaber

	Fig.	Ø
27-3095-00	0	4 mm
27-3096-00	1	5 mm
27-3097-00	2	6 mm
27-3098-00	3	7 mm
27-3099-00	4	8 mm
27-3100-00	5	9 mm
27-3101-00	6	10 mm
27-3102-00	7	11 mm
27-3103-00	8	12 mm



Krishaber-Luer

	Fig.	Ø
27-3105-00	0	4 mm
27-3106-00	1	5 mm
27-3107-00	2	6 mm
27-3108-00	3	7 mm
27-3109-00	4	8 mm
27-3110-00	5	9 mm
27-3111-00	6	10 mm
27-3112-00	7	11 mm
27-3113-00	8	12 mm



Parker

	Fig.	Ø
27-3120-00	1	16 mm
27-3121-00	2	18 mm
27-3122-00	3	20 mm
27-3123-00	4	22 mm
27-3124-00	5	24 mm
27-3125-00	6	26 mm
27-3126-00	7	28 mm
27-3127-00	8	30 mm
27-3128-00	9	32 mm



Alphabetical Index

Alphabetical Index

The background of the page is a high-quality photograph of various surgical instruments, including forceps, scissors, and retractors, arranged on a white surface. The instruments are shown in a shallow depth of field, with some in sharp focus and others blurred in the background. The lighting is bright and even, highlighting the metallic texture of the tools.

ABRAHAM Tonsil Knives	48
Adenoid Curettes	17-19
Air Bags	8
ALLIGATOR Micro Ear Forceps	25
ALLOY Tuning Forks	1
Antrum Punch	39
Antrum Punches Forceps	42
Attic Dissector	10
AUSTIN Micro Ear Hooks	10
Bags, Air	8
BALLENGER Nasal Knives	44
BALLENGER Tonsil Forceps	51
BALLENGER-SLUDER Tonsillotomy	55
BARACANI Exchangeable Tips	57
BARBARA Micro Ear Needles	9
BARBARA Micro Ear Needles & Hooks	9
BARBON-LUBET Nasal Tampon Forceps	35
BARKER Ear Scoop	13
BECKMAN Nasal Specula	30
BECKMANN Adenoid Curettes	17, 18
BELLUCCI Micro Ear Scissors	26
Bending Forceps for Wire	24
BEYER Mastoid Rongeurs	27
BILLEAU Ear Loop	13
BLAKESLEY-WEIL Nasal Cutting Forceps	38
BLOHMKE Tonsil Seizing Forceps	52
Bone Curettes	18
Bone Holding Forceps	54
Bone Punches, Sphenoid	41
BOSE Tracheotomy Retractors	61
BOUCHERON Ear Specula	5
Broncho Forceps	56
BRUENINGS Ethmoid Bone Forceps	36
BRUENINGS Exchangeable Tips	57
BRUENINGS Interchangeable Tubes	56
BRUENINGS Tonsil Snares	53
BUCK Ear Curettes	20
BUCK Foreign Body Forceps	21
CANFIELD Tonsil Knives	48
Cannulas	19
CAPLAN Septum Scissors	40
CARPENTER Tonsil Knives, Dissectors	49
Chain for Retractor	54
CHEVALIER-JACKSON Broncho-Esophagoscopy Forceps	56
CHEVALIER-JACKSON Tracheal Tubes	63
Circular Cut Knife	12
CITELLI Mastoid Rongeurs	27
COAKLEY Adenoid Curettes	17
COLLIN Tracheal Tubes	65
COLVER Tonsil Forceps	51
COLVER Tonsil Knives	48
Compression Forceps	35
Connecting Nozzle for Air Bag	8
CONVERSE Nasal Knives	44
CORDES Exchangeable Tips	57
COTTLE Nasal Knives	43, 44
COTTLE Nasal Specula	31
CUBLEY Tracheal Tubes	65
Cup-Shaped-Forceps, Micro	25
Curette Sharpener	18
Curettes	17-21
Curettes, Adenoid	17-20
Curettes, Bone	18
Curettes, Ear	20
Curettes, Micro	11
Curettes, Tympanum	13
CUSHING-FERRIS-SMITH Rongeur Forceps	42
Cutting Forceps, Nasal	37-39
DAY Ear Hooklets	15
DAY Tonsil Knives	48
DENIS-BROWNE Tonsil Seizing Forceps	52
DIETER-HOUSE Micro Ear Forceps	24

Dilators, Tracheotomy	61
Dissectors	10, 49, 50
Dissectors, Attic	10
Dissectors, Micro	10
Dissectors, Throat	50
DOUGLAS Tonsil Knives	48
DUPUY-WEISS Tonsil Needles	47
DURHAM Septum Elevators	46
DURHAM Tonsil Needles	47
Ear Curettes	20
Ear Forceps	34
Ear Forceps, Micro	23-25
Ear Hooklets	14, 15
Ear Hooks, Micro	9, 10
Ear Knives, Micro	12
Ear Loop	13, 14
Ear Needles, Micro	9
Ear Olive	8
Ear Periosteal Elevators	16
Ear Polypus Forceps	22
Ear Polypus Snares	21
Ear Scissors, Micro	26
Ear Scoops	13, 16
Ear Specula	4, 6
Ear Specula Storage Rack	5
Ear Syringes	6, 7
Ear Syringes Catheters	6
EICKEN-KILLIAN Cannulas	19
Elevators, Periosteal	10, 16
Elevators, Septum	45, 46
Enucleator	49
Epiglottis Retractor	59
ERHARDT Ear Specula	4
Esophagoscopy Forceps	56
Ethmoid Bone Forceps	36-38
EVES Tonsil Snares	53
Exchangeable Tips	57
Exploring Hook	10
FAULKNER Adenoid Curettes	17
FERRIS-SMITH-CUSHING Rongeur Forceps	42
FISCH Micro Dissectors	10
FISHER Tonsil Knives	48
Flap Knife	12
FOMON Nasal Knives	44
Forceps, Antrum Punches	42
Forceps, Bone Holding	54
Forceps, Broncho	56
Forceps, Cup-Shaped, Micro	25
Forceps, Ear	34
Forceps, Ear Polypus	22
Forceps, Esophagoscopy	56
Forceps, Ethmoid Bone	36-38
Forceps, Foreign Body	21
Forceps, Introducing	24
Forceps, Laryngeal Polypus	59, 60
Forceps, Measuring	54
Forceps, Micro Ear	23-25
Forceps, Nasal Cutting	37-39
Forceps, Nasal Polypus	35
Forceps, Nasal Tampon	34, 35
Forceps, Rongeur	42
Forceps, Septum	36, 40
Forceps, Septum Compression	35
Forceps, Tonsil	51
Forceps, Tonsil Seizing	52
Forceps, Wire Bending	24
Forceps, Wire Closure	27
Foreign Body Forceps	21
Foreign Body Instruments	14
Foreign Body Lever	14, 21
Forks, Tuning	1-3
FRAENKEL Exchangeable Tips	57

Alphabetical Index

FRAENKEL Laryngeal Polypus Forceps	60	JACKSON-CHEVALIER Tracheal Tubes	63
FREER Mucosa Knife	44	JANSEN Ear Forceps	34
FREER Nasal Knives	44	JANSEN Micro Curettes	11
FREER Septum Elevators	45, 46	JANSEN-GRUENWALD Nasal Tampon Forceps	34
FREER Septum Knives	45, 46	JANSEN-MIDDELTON Septum Forceps	40
FRENCH Tuning Forks	2	JANSEN-STRUYCKEN Septum Forceps	40
FULLER Introduction Forceps	24	JOSEPH Rhinoplastic Knives	43
FULLER Micro Ear Forceps	24	JURASZ Laryngeal Polypus Forceps	60
FULLER Tracheal Tubes	65	KAHLER Laryngeal Polypus Forceps	59
Furuncle Knife	11	KEEN Bone Holding Forceps	54
Gauze Packers	50	KERRISON Antrum Punches Forceps	42
GLEGG Polypus Snares	33	KILLIAN Cannulas	19
GOLDSMITH-THUDICHUM Nasal Specula	28	KILLIAN Nasal Polypus Forceps	35
GRAIG Septum Forceps	36	KILLIAN Nasal Specula	31
GREVEN Mastoid Rongeurs	27	KILLIAN Septum Scissors	40
GREVEN Wire Closure Forceps	27	Knife, Circular Cut	12
GROSS Ear Scoop	13	Knife, Flap	12
GRUBER Ear Specula	4	Knife, Furuncle	11
GRUENWALD-JANSEN Nasal Tampon Forceps	34	Knife, Micro	12
HAJEK Nasal Cutting Forceps	39	Knife, Mucosa	12, 41
HAJEK Sphenoid Bone Punches	41	Knife, Nasal	43, 44
HAJEK-KOFLER Sphenoid Bone Punches	41	Knife, Rhinoplastic	43, 44
HALLE-HARTMANN Nasal Specula	29	Knife, Rotary	12
Handle, Universal	56	Knife, Septum	45, 46
Handles, Laryngeal	58	Knife, Sickle	12
HARGIS Bone Holding Forceps	54	Knife, Tonsil	48, 49
HARGIS Retractor Chain	54	KNIGHT Septum Forceps	36
HARTMANN Cannulas	19	KNIGHT-HEYMANN Nasal Polypus Forceps	35
HARTMANN Ear Polypus Forceps	22	KOFLER-HAJEK Sphenoid Bone Punches	41
HARTMANN Ear Polypus Snares	21	KONIG Tuning Forks	3
HARTMANN Ear Specula	4	KRAUSE Exchangeable Tips	57
HARTMANN Ear Syring Catheters	6	KRAUSE Polypus Snares	33
HARTMANN Ear Hooklet	14	KRAUSE-VOSS Polypus Snares	33
HARTMANN Nasal Cutting Forceps	39	KRIEG Nasal Knives	43
HARTMANN Nasal Polypus Forceps	35	KRISHABER Tracheal Tubes	64
HARTMANN Nasal Specula	29	KRISHABER-LUER Tracheal Tubes	64
HARTMANN Tonsillotomy	55	LABORDE Tracheotomy Dilators	61
HARTMANN Tuning Forks	2	LANGE Exchangeable Tips	57
HARTMANN-HALLE Nasal Specula	29	LANGENBECK Micro Curettes	11
HARTMANN-HOFFMANN Ear Polypus Forceps	22	LANGE-WILDE Polypus Snares	33
HARTMANN-NOYES Ear Polypus Forceps	22	Laryngeal Handles	58
HARTMANN-WEINGARTNER Ear Polypus Forceps	22	Laryngeal Mirrors	58
HARTMANN-WULLSTEIN Ear Polypus Forceps	22	Laryngeal Polypus Forceps	59, 60
HENCKEL Nasal Cutting Forceps	37	LEMPERT Ear Periosteal Elevators	16
HENKE Enucleator	49	LEMPERT Ear Scoops	16
HEYMANN Nasal Knives	43	Lever, Foreign Body	14, 21
HEYMANN Nasal Septum Compression Forceps	35	LITTAUER Ear Polypus Snares	21
HEYMANN-KNIGHT Nasal Polypus Forceps	35	LITTAUER Nasal Polypus Forceps	35
HILL Septum Elevators	46	LOCH-WEBER Foreign Body Instruments	14
HOFFMANN-HARTMANN Ear Polypus Forceps	22	Loop, Ear	13, 14
Holding Forceps, Bone	54	LOTHROP-MCWHOPPER Tonsil Seizing Forceps	52
Hook, Exploring	10	LUBET-BARBON Nasal Tampon Forceps	35
Hooklet	14	LUC Ethmoid Bone Forceps	36
Hooklets	15	LUCAE Ear Forceps	34
Hooks, Micro	9, 10	LUCAE Ear Hooklets	15
Hooks, Tracheal	62	LUCAE Ear Syring Catheters	6
HOUSE Micro Curettes	11	LUCAE Tuning Forks	3
HOUSE Micro Measuring Rod	10	LUCAE Tympanum Needles	13
HOUSE-DIETER Micro Ear Forceps	24	LUER Tracheal Retractors	62
HOWARTH Septum Elevators	46	LUER Tracheal Tubes	63
HUBER Universal Handle	56	LUER-KRISHABER Tracheal Tubes	64
HURD Packer Retractors	49	LUKENS Tracheal Retractors	62
HURD Throat Dissectors & Retractors	50	LUNIATSCHEK Gauze Packers	50
HURD Tonsil Needles	47	LYNCH Tonsil Knives	48
Interchangeable Tube	56	Malleus Nipper	24
Introducing Forceps	24	MARCHAC Cannulas	19
ITERSON Tracheotomy Retractors	61	MASTOID Ear Searcher	15
JACKSON Epiglottis Retractor	59	Mastoid Rongeurs	27
JACKSON Laryngeal Polypus Forceps	59	McGEE Micro Ear Forceps	24
JACKSON Tracheal Hooks	62	McGEE Micro Ear Hooks	9
JACKSON Tracheal Retractors	62	McGEE-Mini Micro Ear Forceps	23
JACKSON-CHEVALIER Broncho-Esophagoscopy Forceps	56	MCWHOPPER-LOTHROP Tonsil Seizing Forceps	52

Measuring Forceps	54
Measuring Rod for Micro	10
MICHEL Moveable Mirror	58
Micro Cup-Shaped-Forceps	25
Micro Curettes	11
Micro Dissectors	10
Micro Ear Forceps	23-25
Micro Ear Hooks	9, 10
Micro Ear Knives	12
Micro Ear Needles	9
Micro Ear Periosteal Elevator	10
Micro Ear Scissors	26
Micro Measuring Rod	10
MIDDELTON-JANSEN Septum Forceps	40
MINI-MCGEE Micro Ear Forceps	23
Mirrors, Laryngeal	58
MOLDENHAUER Foreign Body Instruments	14
Moveable Mirror	58
Mucosa Knife	12, 41
MUSEUX Tonsil Forceps	51
MUSEUX Tonsil Seizing Forceps	52
MYLES Adenoid Curettes	17
MYLES Ear Curettes	20
MYLES Nasal Cutting Forceps	39
NAGER Dissectors	50
Nasal Cutting Forceps	37-39
Nasal Knives	43, 44
Nasal Polypus Forceps	35
Nasal Specula	28-32
Nasal Tampon Forceps	34, 35
Needles, Micro	9
Needles, Tonsil	47
Needles, Tympanum	11, 13
Nipper, Malleus	24
Nose Olive	8
NOYES-HARTMANN Ear Polypus Forceps	22
Olive for Ear & Nose	8
Packer Retractors	49
Packers, Gauze	50
PAPILLOMA Laryngeal Polypus Forceps	59
PARKER Tracheal Tubes	64
Periosteal Elevators	10, 16
PIMEROY Ear Syringes Catheters	6
PLASTER Micro Ear Knives	12
POLITZER Air Bags	8
POLITZER Ear Specula	4
POLITZER Furuncle Knife	11
POLITZER Tympanum Needles	11, 13
Polypus Forceps	22, 59, 60
Polypus Snares	21, 33
PRITCHARD Ear Specula	4
Punch, Antrum	39
Punches Forceps, Antrum	42
Punches, Sphenoid Bone	41
QUIRE Foreign Body Lever	21
Rack for Ear Specula	45, 46
Raspatories	5
Retractors	49, 50, 54, 59, 61, 62
Retractors, Chain	54
Retractors, Epiglottis	59
Retractors, Throat	50
Retractors, Tracheal	62
Rhinoplastic Knives	43, 44
Rhodium Handle	58
Rod, Micro Measuring	10
Rongeur Forceps	42
Rongeurs, Mastoid	27
ROSE Tracheal Retractors	62
ROSEN Micro Ear Knives	12
ROSEN Micro Ear Periosteal Elevator	10
ROSENBERG Exchangeable Tips	57
Rotary Knife	12

RUBIN Septum Forceps	40
RYDEL-SEIFFERT Tuning Forks	3
SAKAMOTO Bone Measuring Forceps	54
SALYER Bone Holding Forceps	54
SCHEINMANN Exchangeable Tips	57
SCHMEDEN Nasal Cutting Forceps	39
SCHNIDT Tonsil Forceps	51
SCHUKNECHT Micro Ear Knives	12
SCHUMACHER Exchangeable Tips	57
Scissors, Micro Ear	26
Scissors, Septum	40
Scoops	13, 16
Scoops, Tympanum	13
SEIFFERT Exchangeable Tips	57
SEIFFERT-RYDEL Tuning Forks	3
Seizing Forceps, Tonsil	52
Septum Compression Forceps	35
Septum Elevators	45, 46
Septum Forceps	36, 40
Septum Knives	45, 46
Septum Scissors	40
SHAMBAUGH Micro Ear Hooks	10
SHAPLEIGH Micro Curettes	11
Sharpener, Curette	18
SHEA Micro Ear Hooks	10
Sickle Knife	12
SIEGLE Ear Syringes Catheters	6
SLUDER-BALLENGER Tonsillotomy	55
SMITH-CUSHING-FERRIS Rongeur Forceps	42
Snares, Ear Polypus	21
Snares, Polypus	33
Snares, Tonsil	53
Snear Wire	34
Specula, Ear	4
Specula, Nasal	28-32
Specula, Storage Rack	5
Sphenoid Bone Punches	41
ST. CLAIR THOMSON Nasal Specula	28
ST. CLAIR-THOMSON Adenoid Curettes	19
STAMMBERGER Antrum Punch	39
Storage Rack for Ear Specula	5
STRUEMPEL Ear Polypus Forceps	22
STRUYCKEN Nasal Cutting Forceps	37
STRUYCKEN-JANSEN Septum Forceps	40
Suction Nozzle	7
Syringes	6, 7
Syringes Catheters, Ear	6
TABB Mucosa Knife	12
TAKAHASHI Ethmoid Bone Forceps	37
Tampon Forceps, Nasal	34, 35
TC-RUBIN Septum Forceps	40
TESSIER Bone Curettes	18
TESSIER Curette Sharpener	18
TESSIER Nasal Specula	32
THILENIUS Tonsil Seizing Forceps	52
THOMSON-ST. CLAIR Adenoid Curettes	19
Throat Dissector	50
Throat Retractor	50
THUDICHUM-GOLDSMITH Nasal Specula	28
TIECK-HALLE Nasal Specula	30
TILLEY Ear Polypus Snares	21
Tips, Exchangeable	57
TIVNEN-TYDING Tonsil Seizing Forceps	52
Tonsil Forceps	51
Tonsil Knives	48, 49
Tonsil Needles	47
Tonsil Seizing Forceps	52
Tonsil Snares	53
Tonsillotomy	55
TOYNBEE Ear Specula	4
Tracheal Hooks	62
Tracheal Retractors	62



Index by Code



Index by Code

Item	Page
13-3445-19	51
13-3446-19	51
13-3450-19	51
13-3451-19	51
19-0957-01	31
19-0957-02	31
19-0957-03	31
19-0957-04	31
19-0957-05	31
19-0957-06	31
19-0957-07	31
19-0957-08	31
19-0957-09	31
19-0957-10	31
27-3001-13	61
27-3002-13	61
27-3005-14	61
27-3010-14	61
27-3015-07	61
27-3020-18	61
27-3025-18	61
27-3030-16	61
27-3031-16	61
27-3035-13	62
27-3040-11	62
27-3045-15	62
27-3050-18	62
27-3055-17	62
27-3065-00	63
27-3066-00	63
27-3067-00	63
27-3068-00	63
27-3069-00	63
27-3070-00	63
27-3071-00	63
27-3072-00	63
27-3073-00	63
27-3074-00	63
27-3080-00	63
27-3081-00	63
27-3082-00	63
27-3083-00	63
27-3084-00	63
27-3085-00	63
27-3086-00	63
27-3087-00	63
27-3088-00	63
27-3089-00	63
27-3095-00	64
27-3096-00	64
27-3097-00	64
27-3098-00	64
27-3099-00	64
27-3100-00	64
27-3101-00	64
27-3102-00	64
27-3103-00	64
27-3105-00	64
27-3106-00	64
27-3107-00	64
27-3108-00	64
27-3109-00	64
27-3110-00	64
27-3111-00	64
27-3112-00	64

Item	Page
27-3113-00	64
27-3120-00	64
27-3121-00	64
27-3122-00	64
27-3123-00	64
27-3124-00	64
27-3125-00	64
27-3126-00	64
27-3127-00	64
27-3128-00	64
27-3130-00	65
27-3131-00	65
27-3132-00	65
27-3133-00	65
27-3134-00	65
27-3135-00	65
27-3136-00	65
27-3137-00	65
27-3138-00	65
27-3140-00	65
27-3141-00	65
27-3142-00	65
27-3143-00	65
27-3144-00	65
27-3145-00	65
27-3146-00	65
27-3147-00	65
27-3150-00	65
27-3151-00	65
27-3152-00	65
27-3153-00	65
27-3154-00	65
27-3155-00	65
27-3156-00	65
27-3157-00	65
27-3158-00	65
36-3001-00	1
36-3005-00	1
36-3010-00	1
36-3015-00	1
36-3020-00	1
36-3025-00	1
36-3030-00	1
36-3035-00	1
36-3040-00	1
36-3045-00	1
36-3050-00	1
36-3055-00	2
36-3060-00	2
36-3063-00	2
36-3065-00	2
36-3070-00	2
36-3075-00	3
36-3080-00	3
36-3085-00	3
36-3090-00	3
36-3095-00	3
36-3101-00	3
36-3105-00	3
36-3110-00	3
36-3115-00	3
36-3120-00	4
36-3121-00	4
36-3122-00	4
36-3123-00	4

Item	Page
36-3125-00	4
36-3126-00	4
36-3127-00	4
36-3128-00	4
36-3129-00	4
36-3130-00	4
36-3135-00	4
36-3136-00	4
36-3137-00	4
36-3138-00	4
36-3139-00	4
36-3140-00	4
36-3141-00	4
36-3142-00	4
36-3143-00	4
36-3144-00	4
36-3150-00	4
36-3151-00	4
36-3152-00	4
36-3153-00	4
36-3154-00	4
36-3160-00	4
36-3161-00	4
36-3162-00	4
36-3163-00	4
36-3165-00	4
36-3166-00	4
36-3167-00	4
36-3168-00	4
36-3170-00	4
36-3171-00	4
36-3172-00	4
36-3173-00	4
36-3175-00	4
36-3176-00	4
36-3177-00	4
36-3178-00	4
36-3179-00	4
36-3185-00	4
36-3186-00	4
36-3187-00	4
36-3188-00	4
36-3189-00	4
36-3195-03	5
36-3196-00	5
36-3197-00	5
36-3198-00	5
36-3199-00	5
36-3201-00	5
36-3202-00	5
36-3205-03	5
36-3206-03	5
36-3207-03	5
36-3208-03	5
36-3209-03	5
36-3210-03	5
36-3211-03	5
36-3212-03	5
36-3215-00	5
36-3220-00	5
36-3221-00	5
36-3222-00	5
36-3223-00	5
36-3224-00	5
36-3225-00	5

Item	Page
36-3226-00	5
36-3227-00	5
36-3228-00	5
36-3229-00	5
36-3235-00	5
36-3236-00	5
36-3237-00	5
36-3238-00	5
36-3239-00	5
36-3245-00	6
36-3246-00	6
36-3247-00	6
36-3248-00	6
36-3249-00	6
36-3250-00	6
36-3251-00	6
36-3252-00	6
36-3253-00	6
36-3254-00	6
36-3260-00	6
36-3261-00	6
36-3262-00	6
36-3263-00	6
36-3264-00	6
36-3270-00	6
36-3271-00	6
36-3272-00	6
36-3275-00	6
36-3276-00	6
36-3277-00	6
36-3278-00	6
36-3279-00	6
36-3280-00	6
36-3285-00	6
36-3286-00	6
36-3287-00	6
36-3288-00	6
36-3289-00	6
36-3295-00	6
36-3301-00	7
36-3305-00	7
36-3310-00	7
36-3315-00	7
36-3320-00	7
36-3325-00	7
36-3330-00	7
36-3335-00	7
36-3340-00	7
36-3345-00	7
36-3346-00	7
36-3347-00	7
36-3350-00	8
36-3351-00	8
36-3355-00	8
36-3360-00	8
36-3365-00	8
36-3370-00	8
36-3375-00	8
36-3380-16	9
36-3385-16	9
36-3390-16	9
36-3395-16	9
36-3401-16	9
36-3402-16	9
36-3403-16	9

Index by Code

Item	Page	Item	Page	Item	Page	Item	Page
36-3405-16	9	36-3590-15	12	36-3746-16	20	36-3891-00	23
36-3406-16	9	36-3591-15	12	36-3747-16	20	36-3895-00	23
36-3407-16	9	36-3595-18	13	36-3750-16	20	36-3896-00	23
36-3408-16	9	36-3601-16	13	36-3751-16	20	36-3901-00	23
36-3409-16	9	36-3605-16	13	36-3752-16	20	36-3902-00	23
36-3410-16	9	36-3610-18	13	36-3753-16	20	36-3905-00	23
36-3411-16	9	36-3615-18	13	36-3754-16	20	36-3906-00	23
36-3415-16	9	36-3620-17	13	36-3755-16	20	36-3910-00	23
36-3416-16	9	36-3625-12	13	36-3756-16	20	36-3911-00	23
36-3417-16	9	36-3630-12	13	36-3757-16	20	36-3915-00	23
36-3418-16	9	36-3635-12	13	36-3760-16	20	36-3916-00	23
36-3419-16	9	36-3640-12	13	36-3761-16	20	36-3920-00	23
36-3420-16	9	36-3645-12	13	36-3762-16	20	36-3921-00	23
36-3421-16	9	36-3650-16	13	36-3763-16	20	36-3925-00	24
36-3425-16	9	36-3651-16	13	36-3764-16	20	36-3926-00	24
36-3426-16	9	36-3652-16	13	36-3765-16	20	36-3927-00	24
36-3430-15	9	36-3655-16	14	36-3766-16	20	36-3928-00	24
36-3431-15	9	36-3660-15	14	36-3767-16	20	36-3930-00	24
36-3432-15	9	36-3665-15	14	36-3770-16	20	36-3931-00	24
36-3435-15	9	36-3670-16	14	36-3771-16	20	36-3932-00	24
36-3436-15	9	36-3675-14	15	36-3772-16	20	36-3933-00	24
36-3437-15	9	36-3676-14	15	36-3773-16	20	36-3935-00	24
36-3440-15	9	36-3677-14	15	36-3774-16	20	36-3936-00	24
36-3441-15	9	36-3678-14	15	36-3775-16	20	36-3937-00	24
36-3445-15	9	36-3680-17	15	36-3776-16	20	36-3938-00	24
36-3446-15	9	36-3681-17	15	36-3777-16	20	36-3940-00	24
36-3450-15	9	36-3685-00	15	36-3780-17	20	36-3941-00	24
36-3455-15	9	36-3686-00	15	36-3781-17	20	36-3942-00	24
36-3460-00	10	36-3687-00	15	36-3782-17	20	36-3943-00	24
36-3465-00	10	36-3690-14	15	36-3783-17	20	36-3945-00	24
36-3470-00	10	36-3691-14	15	36-3784-17	20	36-3946-00	24
36-3475-00	10	36-3692-14	15	36-3790-12	21	36-3947-00	24
36-3480-00	10	36-3693-14	15	36-3795-12	21	36-3948-00	24
36-3485-00	10	36-3694-14	15	36-3801-14	21	36-3950-00	24
36-3490-00	10	36-3695-14	15	36-3805-16	21	36-3951-00	24
36-3495-00	10	36-3696-14	15	36-3810-00	21	36-3952-00	24
36-3501-15	10	36-3701-20	16	36-3815-00	21	36-3953-00	24
36-3502-15	10	36-3705-18	16	36-3820-08	22	36-3955-00	24
36-3503-15	10	36-3710-21	16	36-3820-12	22	36-3956-00	24
36-3504-15	10	36-3711-21	16	36-3820-14	22	36-3960-00	24
36-3510-15	10	36-3712-21	16	36-3820-16	22	36-3961-00	24
36-3515-15	10	36-3713-21	16	36-3825-08	22	36-3965-00	25
36-3516-15	10	36-3714-21	16	36-3830-08	22	36-3966-00	25
36-3517-15	10	36-3720-16	20	36-3835-08	22	36-3967-00	25
36-3518-15	10	36-3721-16	20	36-3835-12	22	36-3968-00	25
36-3520-14	11	36-3722-16	20	36-3835-14	22	36-3970-00	25
36-3521-14	11	36-3723-16	20	36-3840-09	22	36-3971-00	25
36-3525-14	11	36-3724-16	20	36-3845-09	22	36-3972-00	25
36-3526-14	11	36-3725-16	20	36-3850-08	22	36-3973-00	25
36-3530-13	11	36-3726-16	20	36-3855-08	22	36-3975-00	25
36-3535-15	11	36-3727-16	20	36-3860-08	22	36-3976-00	25
36-3536-15	11	36-3730-16	20	36-3860-12	22	36-3977-00	25
36-3540-17	11	36-3731-16	20	36-3860-14	22	36-3978-00	25
36-3545-14	11	36-3732-16	20	36-3861-08	22	36-3980-00	25
36-3550-17	11	36-3733-16	20	36-3861-12	22	36-3981-00	25
36-3560-00	12	36-3734-16	20	36-3861-14	22	36-3982-00	25
36-3565-14	12	36-3735-16	20	36-3862-08	22	36-3983-00	25
36-3570-15	12	36-3736-16	20	36-3862-12	22	36-3985-00	25
36-3575-00	12	36-3737-16	20	36-3862-14	22	36-3986-00	25
36-3580-15	12	36-3740-16	20	36-3865-08	22	36-3987-00	25
36-3585-15	12	36-3741-16	20	36-3870-08	22	36-3988-00	25
36-3586-15	12	36-3742-16	20	36-3875-08	22	36-3990-00	25
36-3587-15	12	36-3743-16	20	36-3880-08	22	36-3991-00	25
36-3588-15	12	36-3744-16	20	36-3885-08	22	36-3992-00	25
36-3589-15	12	36-3745-16	20	36-3890-00	23	36-3993-00	25

Item	Page
36-3995-00	25
36-3996-00	25
36-3997-00	25
36-3998-00	25
36-4001-00	25
36-4002-00	25
36-4003-00	25
36-4004-00	25
36-4010-00	25
36-4011-00	25
36-4012-00	25
36-4013-00	25
36-4015-00	25
36-4016-00	25
36-4017-00	25
36-4018-00	25
36-4020-00	25
36-4021-00	25
36-4022-00	25
36-4023-00	25
36-4025-00	25
36-4026-00	25
36-4027-00	25
36-4028-00	25
36-4030-00T	25
36-4031-00T	25
36-4032-00T	25
36-4033-00T	25
36-4034-00T	25
36-4035-00T	25
36-4040-00	26
36-4041-00	26
36-4042-00	26
36-4043-00	26
36-4045-00	26
36-4046-00	26
36-4047-00	26
36-4048-00	26
36-4050-00	26
36-4051-00	26
36-4052-00	26
36-4053-00	26
36-4055-00	26
36-4056-00	26
36-4057-00	26
36-4058-00	26
36-4060-00	26
36-4061-00	26
36-4062-00	26
36-4063-00	26
36-4065-00	26
36-4066-00	26
36-4067-00	26
36-4068-00	26
36-4070-00	26
36-4071-00	26
36-4072-00	26
36-4073-00	26
36-4075-00	26
36-4076-00	26
36-4077-00	26
36-4078-00	26
36-4080-00	26
36-4081-00	26
36-4082-00	26

Item	Page
36-4083-00	26
36-4085-00	27
36-4090-00	27
36-4091-00	27
36-4095-00	27
36-4101-00	27
37-3001-00	28
37-3002-00	28
37-3003-00	28
37-3004-00	28
37-3005-00	28
37-3010-00	28
37-3011-00	28
37-3012-00	28
37-3015-00	28
37-3016-00	28
37-3017-00	28
37-3020-00	28
37-3025-19	28
37-3030-16	29
37-3031-16	29
37-3032-16	29
37-3035-15	29
37-3036-15	29
37-3037-15	29
37-3040-13	29
37-3045-13	30
37-3050-13	30
37-3051-13	30
37-3055-15	30
37-3060-14	30
37-3060-17	62
37-3061-14	30
37-3062-14	30
37-3063-14	30
37-3064-14	30
37-3085-14	31
37-3086-14	31
37-3087-14	31
37-3088-14	31
37-3089-14	31
37-3090-14	31
37-3091-14	31
37-3092-14	31
37-3093-14	31
37-3094-14	31
37-3095-00	31
37-3096-00	31
37-3101-17	32
37-3102-17	32
37-3103-17	32
37-3104-17	32
37-3110-00	33
37-3111-00	33
37-3113-00	33
37-3115-26	33
37-3120-26	33
37-3125-00	33
37-3130-00	33
37-3135-25	33
37-3140-11	34
37-3145-12	34
37-3150-13	34
37-3155-14	34
37-3156-14	34

Item	Page
37-3160-16	34
37-3160-20	34
37-3165-00	34
37-3166-00	34
37-3170-10	34
37-3171-10	34
37-3175-15	34
37-3180-18	34
37-3185-16	34
37-3185-20	34
37-3190-16	35
37-3195-18	35
37-3201-20	35
37-3205-18	35
37-3210-17	35
37-3215-20	35
37-3220-20	35
37-3225-18	35
37-3226-18	35
37-3227-18	35
37-3230-18	36
37-3235-18	36
37-3240-18	36
37-3241-18	36
37-3245-20	36
37-3246-20	36
37-3250-20	36
37-3251-20	36
37-3255-19	36
37-3256-19	36
37-3257-19	36
37-3258-19	36
37-3260-19	37
37-3261-19	37
37-3265-19	37
37-3266-19	37
37-3270-20	37
37-3275-19	37
37-3276-19	37
37-3280-19	38
37-3281-19	38
37-3282-19	38
37-3283-19	38
37-3284-19	38
37-3290-19	38
37-3291-19	38
37-3292-19	38
37-3293-19	38
37-3294-19	38
37-3300-12	38
37-3301-12	38
37-3302-12	38
37-3303-12	38
37-3310-12	38
37-3311-12	38
37-3312-12	38
37-3313-12	38
37-3315-12	38
37-3316-12	38
37-3317-12	38
37-3318-12	38
37-3320-19	39
37-3321-19	39
37-3322-19	39
37-3323-19	39

Item	Page
37-3325-19	39
37-3326-19	39
37-3327-19	39
37-3330-19	39
37-3331-19	39
37-3332-19	39
37-3333-19	39
37-3335-19	39
37-3340-19	39
37-3345-00	39
37-3346-00	39
37-3347-00	39
37-3350-19	40
37-3355-19	40
37-3360-19	40
37-3365-21	40
37-3370-21T	40
37-3375-20	40
37-3380-21	40
37-3415-00	41
37-3416-00	41
37-3417-00	41
37-3418-00	41
37-3420-00	42
37-3421-00	42
37-3422-00	42
37-3423-00	42
37-3424-00	42
37-3430-00	42
37-3431-00	42
37-3432-00	42
37-3433-00	42
37-3434-00	42
37-3440-00	42
37-3441-00	42
37-3442-00	42
37-3443-00	42
37-3444-00	42
37-3450-20	42
37-3451-20	42
37-3452-20	42
37-3455-15	43
37-3456-15	43
37-3457-15	43
37-3458-15	43
37-3460-15	43
37-3461-15	43
37-3462-15	43
37-3463-15	43
37-3465-00	43
37-3470-00	43
37-3475-15	43
37-3480-00	43
37-3485-00	44
37-3490-00	44
37-3495-00	44
37-3501-16	44
37-3505-16	44
37-3510-14	44
37-3515-00	45
37-3520-00	45
37-3525-19	45
37-3530-19	45
37-3535-19	45
37-3540-19	45

Index by Code

Item	Page	Item	Page	Item	Page	Item	Page
37-3545-16	46	39-3075-22	49	39-4007-30	56	39-4155-30	59
37-3545-19	46	39-3080-23	49	39-4007-40	56	39-4160-30	59
37-3550-00	46	39-3085-23	49	39-4007-50	56	39-4165-30	59
37-3560-00	46	39-3090-23	49	39-4007-60	56	39-4166-30	59
37-3565-00	46	39-3095-24	50	39-4010-00	56	39-4170-30	59
37-3570-18	46	39-3101-22	50	39-4015-20	56	39-4175-12	59
37-3570-22	46	39-3105-17	50	39-4015-30	56	39-4175-14	59
37-3965-17	17	39-3106-17	50	39-4015-40	56	39-4175-16	59
37-3966-17	17	39-3110-17	50	39-4015-50	56	39-4175-18	59
37-3967-17	17	39-3125-19	51	39-4015-60	56	39-4175-20	59
37-3968-17	17	39-3126-19	51	39-4020-20	56	39-4175-30	59
37-3969-17	17	39-3130-18	51	39-4025-00	57	39-4175-40	59
37-3975-21	17	39-3130-23	51	39-4030-00	57	39-4175-50	59
37-3980-17	17	39-3135-20	51	39-4035-00	57	39-4180-24	59
37-3981-17	17	39-3140-21	51	39-4040-00	57	39-4181-24	59
37-3982-17	17	39-3145-20	52	39-4045-00	57	39-4185-23	60
37-3983-17	17	39-3150-21	52	39-4050-00	57	39-4190-23	60
37-3984-17	17	39-3151-21	52	39-4055-00	57	39-4191-23	60
37-3985-17	17	39-3155-18	52	39-4056-00	57	39-4192-23	60
37-3990-22	17	39-3160-20	52	39-4060-00	57	39-4193-23	60
37-3991-22	17	39-3165-20	52	39-4061-00	57		
37-3992-22	17	39-3170-18	52	39-4065-00	57		
37-3993-22	17	39-3175-00	53	39-4070-00	57		
37-3994-22	17	39-3180-28	53	39-4071-00	57		
37-3995-22	17	39-3185-28	53	39-4075-00	57		
37-4001-22	18	39-3190-28	53	39-4080-00	57		
37-4002-22	18	39-3195-00	53	39-4081-00	57		
37-4003-22	18	39-3201-16	54	39-4082-00	57		
37-4004-22	18	39-3205-14	54	39-4083-00	57		
37-4005-22	18	39-3210-25	54	39-4085-00	57		
37-4010-21	18	39-3215-17	54	39-4090-00	57		
37-4015-19	18	39-3216-17	54	39-4091-00	57		
37-4020-21	18	39-3220-19	54	39-4095-00	57		
37-4025-21	19	39-3221-00	54	39-4101-00	57		
37-4026-21	19	39-3225-12	55	39-4105-00	58		
37-4027-21	19	39-3226-12	55	39-4106-00	58		
37-4028-21	19	39-3227-12	55	39-4107-00	58		
37-4030-00	19	39-3230-00	55	39-4108-00	58		
37-4031-00	19	39-3231-00	55	39-4109-00	58		
37-4032-00	19	39-3232-00	55	39-4110-00	58		
37-4035-00	19	39-3233-00	55	39-4111-00	58		
37-4036-00	19	39-4001-30	56	39-4112-00	58		
37-4037-00	19	39-4001-40	56	39-4113-00	58		
37-4040-00	19	39-4001-50	56	39-4114-00	58		
37-4041-00	19	39-4001-60	56	39-4115-00	58		
37-4042-00	19	39-4002-30	56	39-4116-00	58		
37-4045-00	19	39-4002-40	56	39-4120-00	58		
37-4050-00	19	39-4002-50	56	39-4121-00	58		
37-4055-00	19	39-4002-60	56	39-4122-00	58		
37-4060-19	19	39-4003-30	56	39-4123-00	58		
39-3001-21	47	39-4003-40	56	39-4124-00	58		
39-3005-21	47	39-4003-50	56	39-4125-00	58		
39-3010-25	47	39-4003-60	56	39-4126-00	58		
39-3015-25	47	39-4004-30	56	39-4127-00	58		
39-3020-22	47	39-4004-40	56	39-4128-00	58		
39-3025-22	47	39-4004-50	56	39-4129-00	58		
39-3030-21	48	39-4004-60	56	39-4130-00	58		
39-3035-22	48	39-4005-30	56	39-4131-00	58		
39-3040-22	48	39-4005-40	56	39-4135-00	58		
39-3045-21	48	39-4005-50	56	39-4140-00	58		
39-3050-21	48	39-4005-60	56	39-4145-25	58		
39-3055-21	48	39-4006-30	56	39-4146-25	58		
39-3060-21	48	39-4006-40	56	39-4147-25	58		
39-3065-20	48	39-4006-50	56	39-4148-25	58		
39-3070-22	49	39-4006-60	56	39-4150-40	59		

ASC MEDICAL Surgical Instruments and Implants are guaranteed to be free of defects in materials and workmanship for life.

ASC MEDICAL Surgical Instruments and Implants that are determined to be defective will be replaced or repaired, at our discretion.

ASC MEDICAL Surgical Instruments and Implants not properly cared for or used for purposes not intended will not be covered.



ASC Medical GmbH & Company KG
take-off GewerbePark 2
78579 Neuhausen o.E. | Tuttlingen, Germany

Phone: + 49 (0) 7467 - 94 960 46
Fax: + 49 (0) 7467 - 94 960 49
www.asc-med.com - info@asc-med.com