

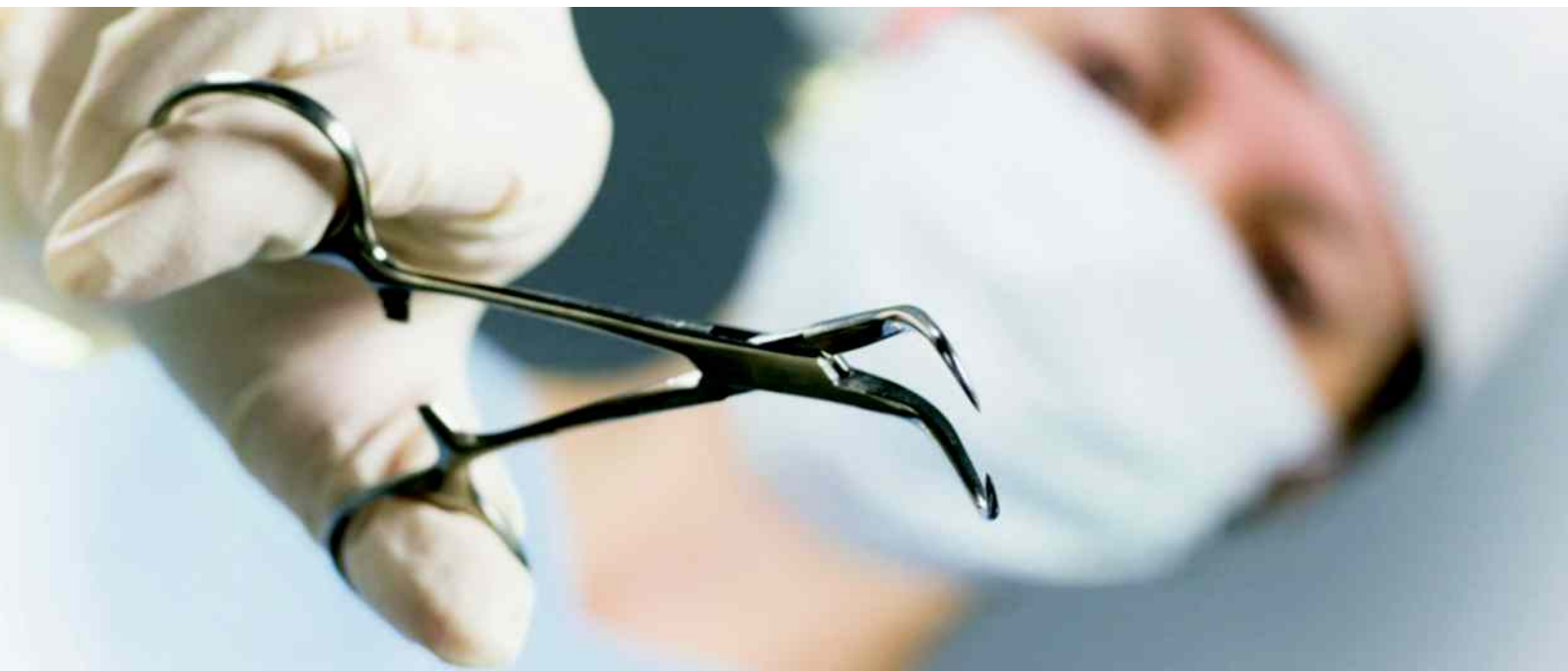

Rectum & OBGYN Instruments





Welcome to ASC Medical GmbH & Co. KG.

The company was founded by Kurt Bucher in the year 2003.

The **ASC MEDICAL** office is located in the heart of Southern Germany, Neuhausen / Tuttlingen.

ASC MEDICAL is dedicated to educating the market on new and improved techniques, implants and instrumentation.

Since the formation of **ASC MEDICAL**, we have dedicated ourselves of bringing instruments and implants at a competitive value to the Medical Market. We are proud of what we have achieved in the last 7 years and look forward to more of the same for many years to come.

When you purchase from **ASC MEDICAL**, you are guaranteed the best in quality and customer service. We not only meet your expectations, we exceed them!

This is what we set out to deliver and has since become known as the "**ASC MEDICAL Philosophy**".

On behalf of the **ASC MEDICAL** team members and our distribution partners, we thank you for your tremendous trust in the past. And with your support, we will continue to deliver the highest quality surgical instruments and implants on the market.

Kurt Bucher
President

Rectum Specula and Rectum Retractors	1-9
Vasectomy	10
Forceps	11-22
Dilators and Scoops	23-25
Retractors	26-31
Circumcision Instruments and Penis Clamps	32-34
Bougies and Guides	35-37
Vaginal Specula	38-59
Dilators and Dilating Forceps	60-64
Tenaculum Forceps	65-70
Polypus Forceps and Sponge Forceps	71-76
Sounds, Curettes, Scoops	77-85
Biopsy Forceps	86-92
Pelvimeters	93,94
Obstetrical Forceps	95-100
Miscellaneous	101-109

Special Note:

ASC is carrying the full range of over 18000 different surgical instruments.

Please do not hesitate to contact us for any instrument which you do not find in this catalogue.



Sims
30-4001-15 Chrome plated
30-4002-15 Stainless steel
15 cm / 6"



Sims
30-4005-15 Chrome plated
30-4006-15 Stainless steel
15 cm / 6"



Czerny
30-4010-22 Chrome plated
30-4011-22 Stainless steel
22 cm / 8 1/2"

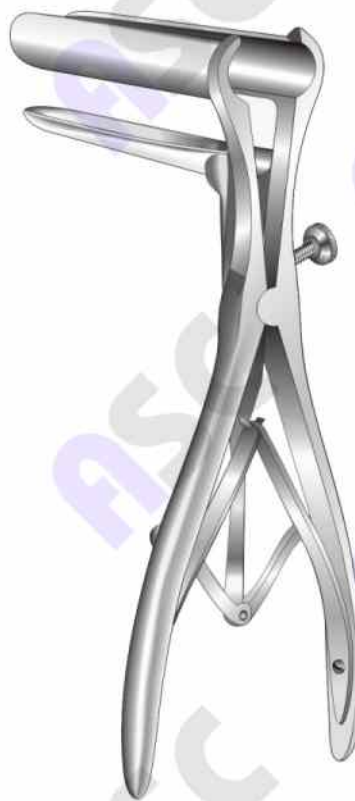

Mathieu
30-4015-19 Chrome plated
30-4016-19 Stainless steel
19.5 cm / 7 3/4"
Working length 90 mm

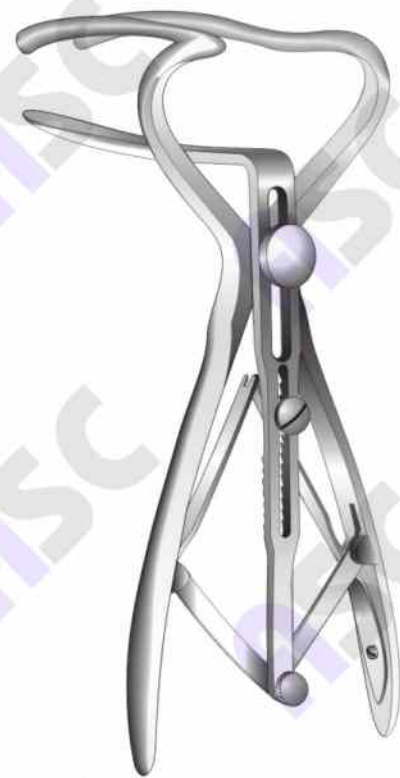

Cook
30-4020-20 Chrome plated
30-4021-20 Stainless steel
20 cm / 8"
4" deep 1/2" wide

Rectal Specula
Mastdarm Spekula
Especulos rectales



Sawyer
30-4025-00 22 x 37 mm
30-4026-00 35 x 75 mm
30-4027-00 22 x 87 mm
 28 cm / 11"

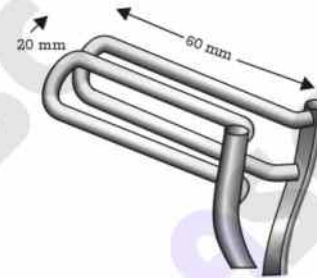
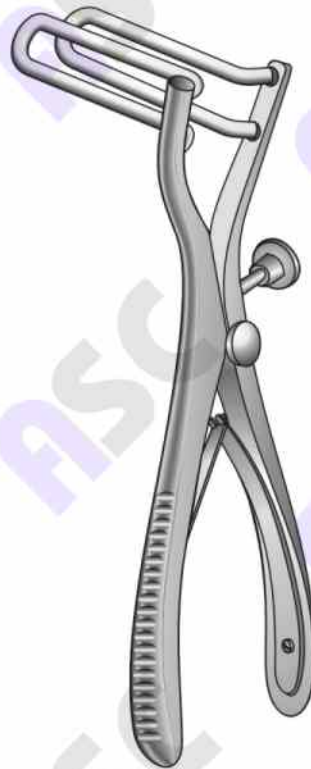

Sims
30-4035-19 Chrome plated
30-4036-19 Stainless steel
 19 cm / 7 1/2"
 For children

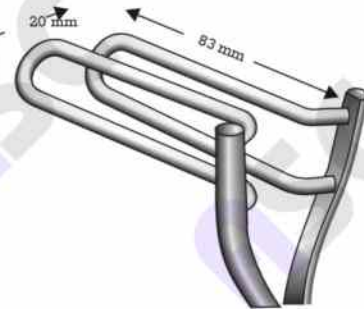

Sims
30-4040-23 Chrome plated
30-4041-23 Stainless steel
 23.5 cm / 9 1/4"
 For adults

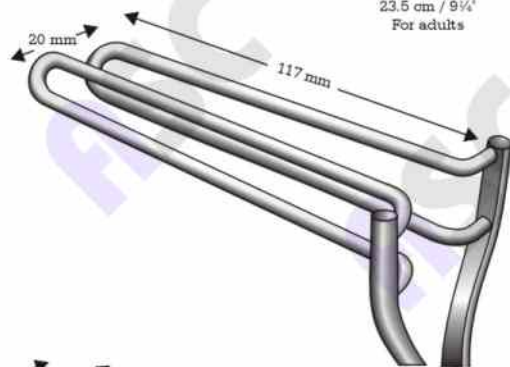

30-4045-23 Chrome plated
30-4046-23 Stainless steel
 23.5 cm / 9 1/4"



Hill-Ferguson
30-4030-21 22 x 65 mm, Small blades
 21.5 cm / 8 1/2"
30-4030-22 30 x 75 mm, Large blades
 22 cm / 8 3/4"



30-4050-24 Chrome plated
30-4051-24 Stainless steel
 24.5 cm / 9 3/4"



Ricord
30-4055-00
Chrome plated



Pratt
30-4065-20
20.5 cm / 8"
Chrome plated



Brinkerhoff
30-4060-00 Small
30-4061-00 Medium
30-4062-00 Large
Chrome plated

Rectal Specula, Retractors
Mastdarm Spekula, Wundhaken
Especulos rectales, Separadores

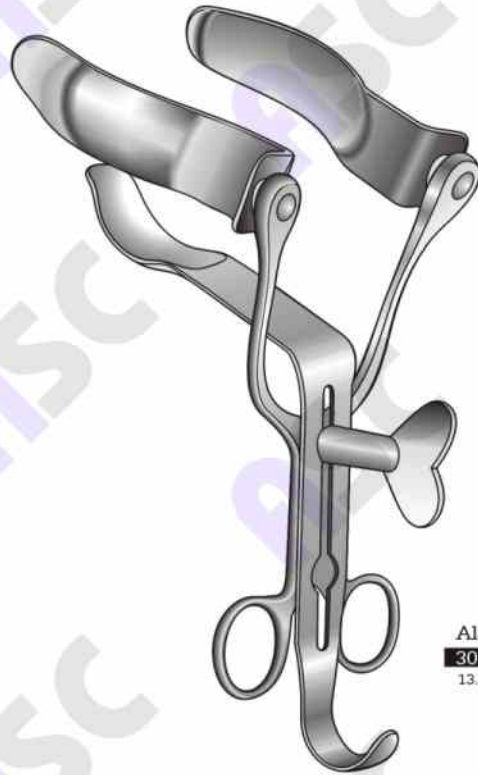

Alan Parks
30-4070-13
13.5 cm / 5 1/2"



Barr
30-4075-20
20.5 cm / 8"

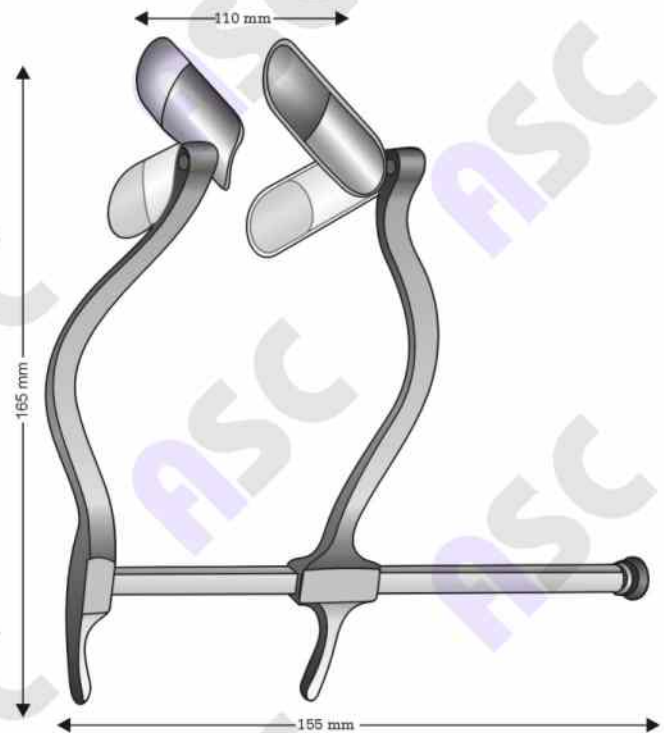

Smith-Buie
30-4080-00



Fansler
30-4085-00
60 x 35 mm



Barr-Shuford
30-4090-00



30-4101-00
Obturator for 30-4095-00

Pennington
30-4095-00
85 x 25 mm \varnothing



Fansler-Ives
30-4105-00
80 x 35 mm \varnothing

Proctoscopes
Proktoskope
Proctoscopios



Kelly
30-4110-00 50 x 21 mm Ø
30-4111-00 50 x 27 mm Ø



Kelly
30-4145-00 64 Ø x 25 mm
30-4146-00 36 Ø x 22 mm



Kelly
30-4160-00 50 x 22 mm Ø
30-4161-00 75 x 22 mm Ø
30-4162-00 100 x 22 mm Ø
30-4163-00 140 x 22 mm Ø
30-4164-00 200 x 22 mm Ø



Gabriel
30-4150-00 64 Ø x 24 mm
30-4151-00 49 Ø x 19 mm

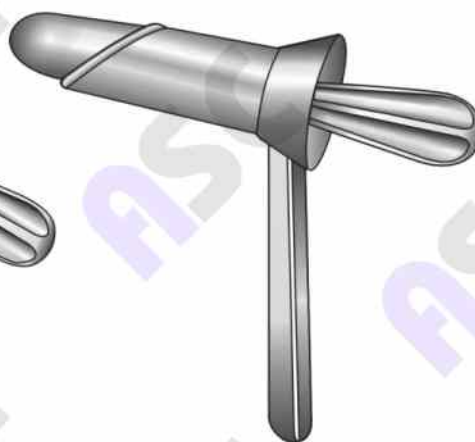

Graeme-Anderson
30-4155-00
 64 Ø x 24 mm

Proctoscopes, Retractors
Proktoskope, Wundhaken
Proctoscopios, Separadores

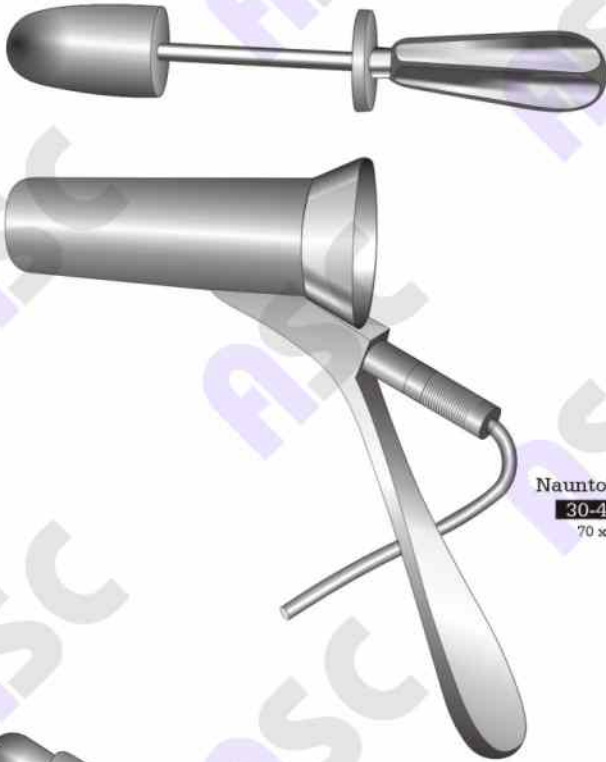

Naunton-Morgan
30-4170-00
70 x 22 mm



Sumikoshi
30-4190-19
19 cm / 7 1/2"
Heavy type, ratched
beckman, eaton type



Bensaude
30-4185-00 70 x 19 mm Ø
30-4186-00 70 x 22 mm Ø



Hirschmann
30-4175-00 65 x 16 mm Ø
30-4176-00 65 x 19 mm Ø
30-4177-00 65 x 22 mm Ø
Chrome plated



Chelsea Eaton
30-4180-00 75 x 22 mm Ø
30-4181-00 75 x 32 mm Ø

Retractors
Wundhaken
Separadores

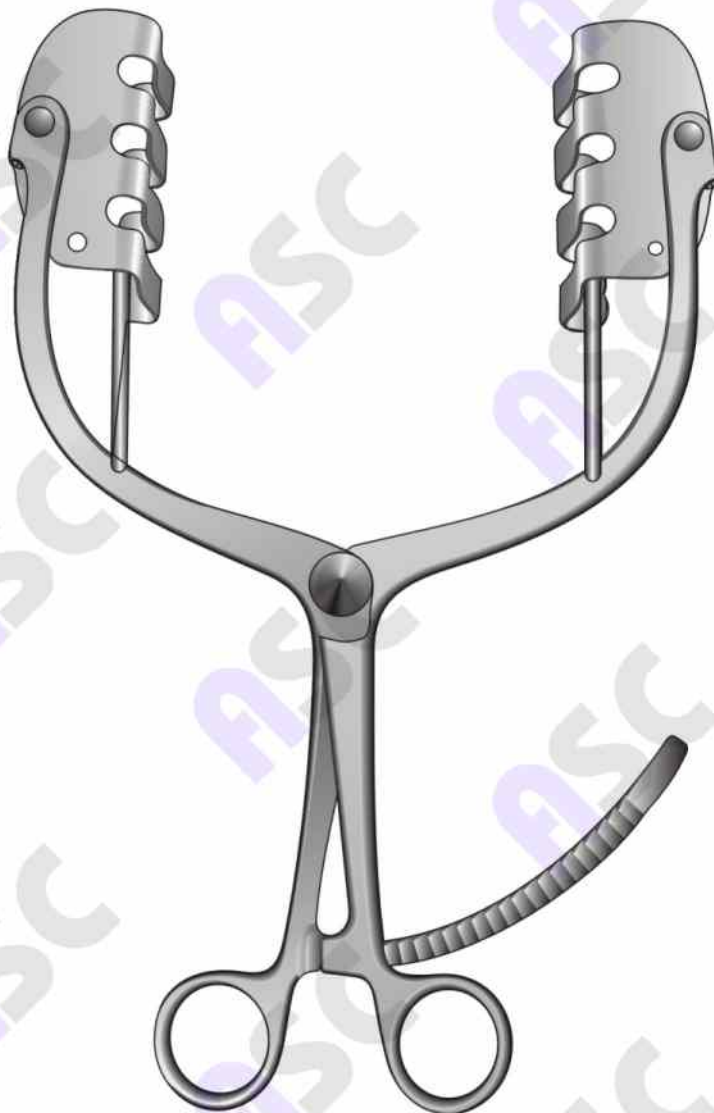

St-Marks

30-4195-00

Complete with 3 pairs of blades
Perineal retractor with towel pegs
fitted to swivel rake blades

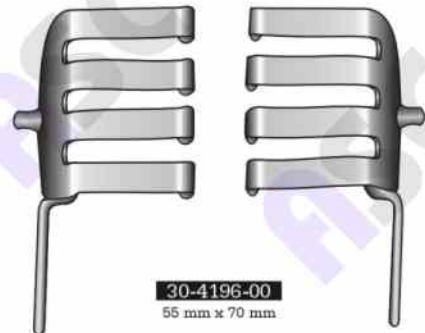

30-4196-00

55 mm x 70 mm

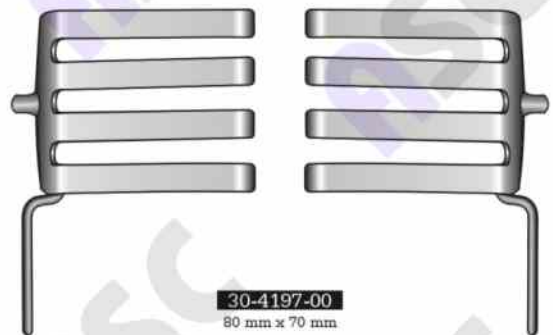

30-4197-00

80 mm x 70 mm

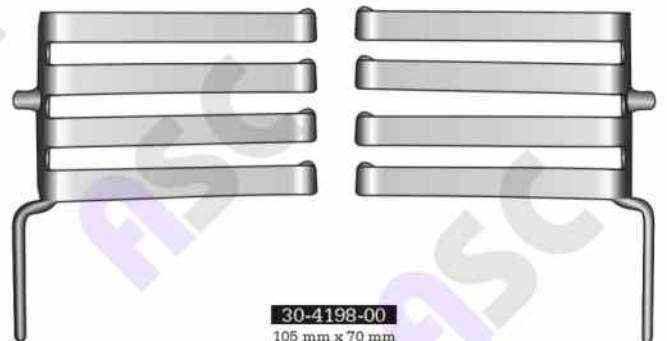

30-4198-00

105 mm x 70 mm



Vasectomy Set

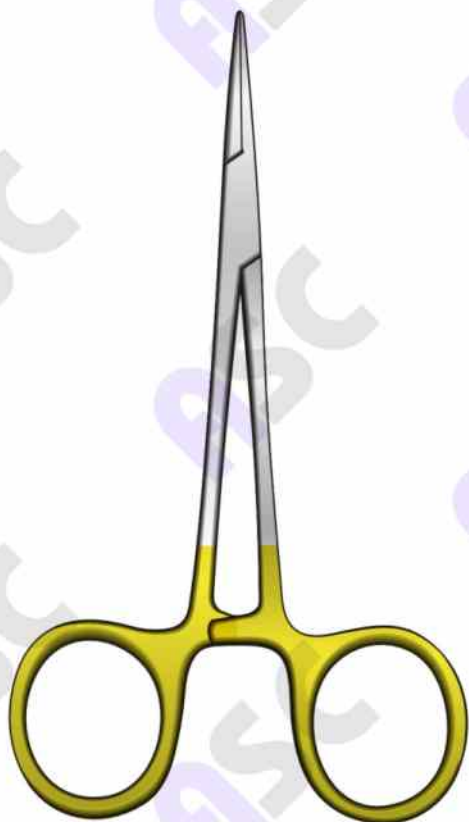

30-4215-12 12 cm
30-4215-14 14 cm
Vasectomy forceps



30-4220-00
Vasectomy hook

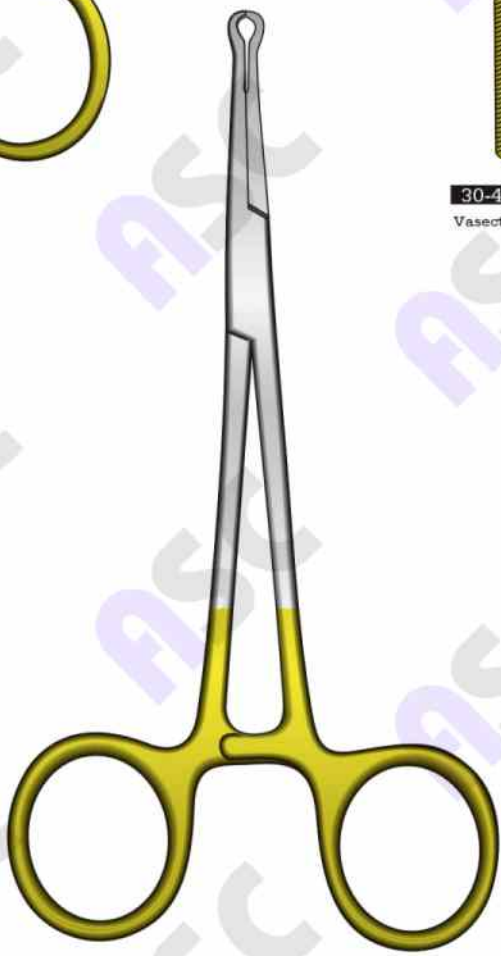

30-4225-00 3 mm tip
30-4226-00 5 mm tip
Vasectomy towel clamp



Vasectomy
30-4230-18
18 cm / 7"
Tip 3.7 mm

Hemorrhoidel Forceps, IUP Grasping Forceps
Hämorrhoidalzangen, IUP Fasszangen
Pinzas para hemorroides, Pinzas para coger DIU



16-3035-37
37.5 cm / 15"
16-3035-45
45 cm / 17½"

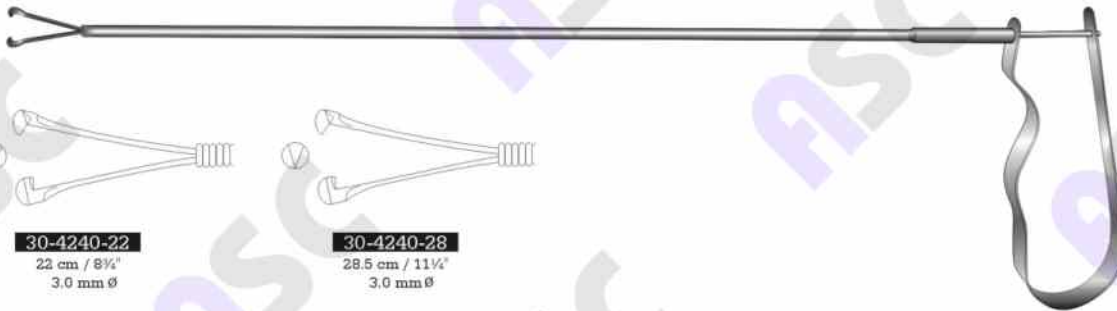

30-4240-22
22 cm / 8½"
3.0 mm Ø

30-4240-28
28.5 cm / 11¼"
3.0 mm Ø

Flexible shaft
For grasping intra uterine pessary

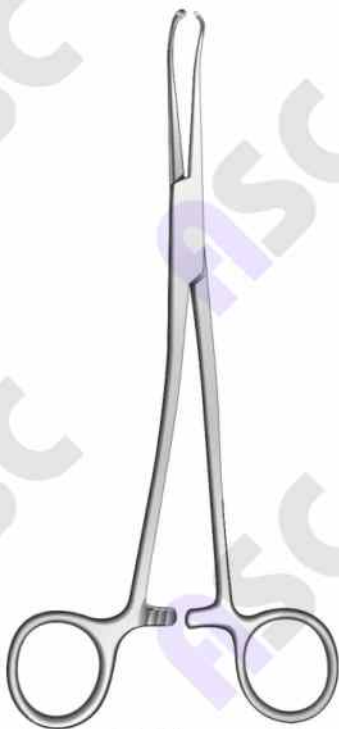

Mc-Givney
30-4245-00
Reverse jaws

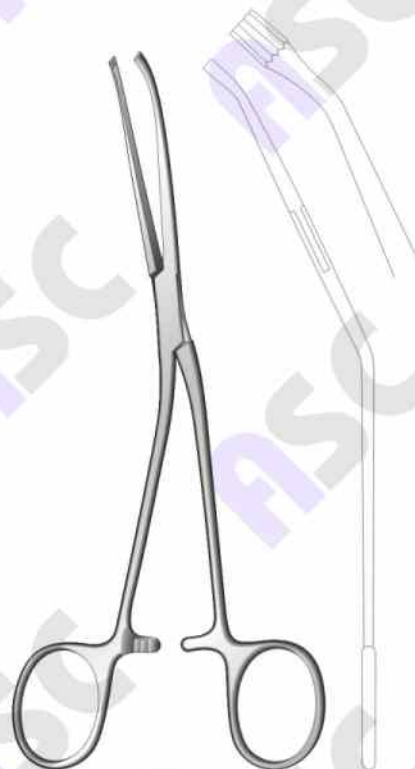

Mc-Givney
30-4250-19
19 cm / 7½"

Hemorrhoidel Forceps
Hämorrhoidalzangen
Pinzas para hemorroides

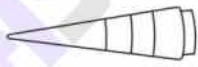

30-4260-00
Stainless steel



30-4265-00
Teflon cone

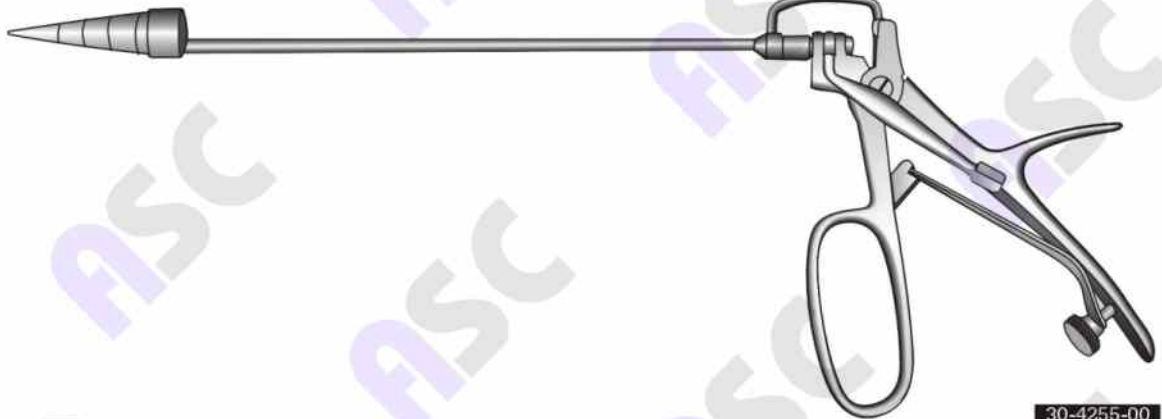

30-4255-00
With stainless steel cone
30-4256-00
With teflon cone



30-4270-00
With stainless steel cone
30-4271-00
With teflon cone

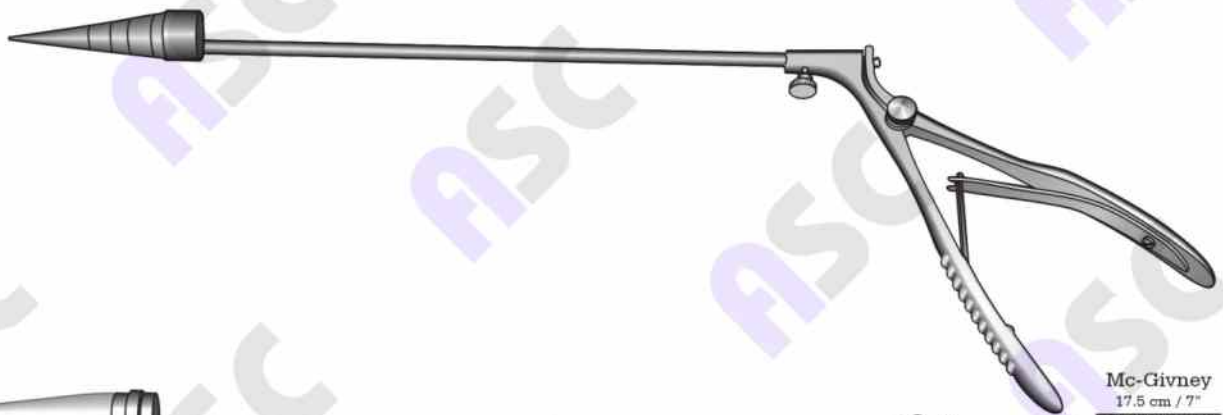

Mc-Givney
17.5 cm / 7"
30-4275-17
With stainless steel cone
30-4276-17
With teflon cone



30-4280-00
With stainless steel cone
30-4281-00
With teflon cone

Rectal Biopsy Specimen Forceps
Mastdarm-Biopsiezangen
Pinzas sacabocados para biopsia rectal

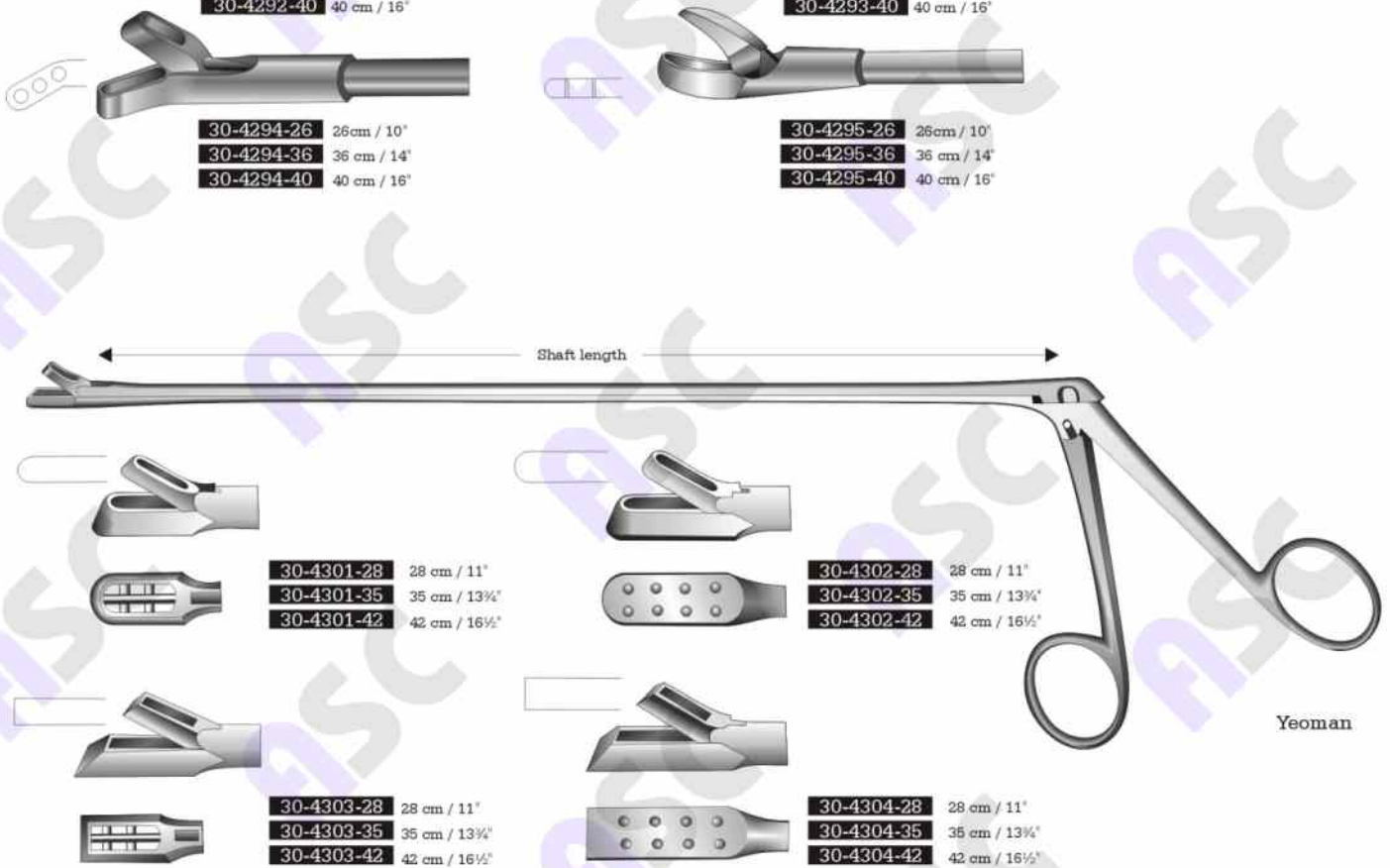
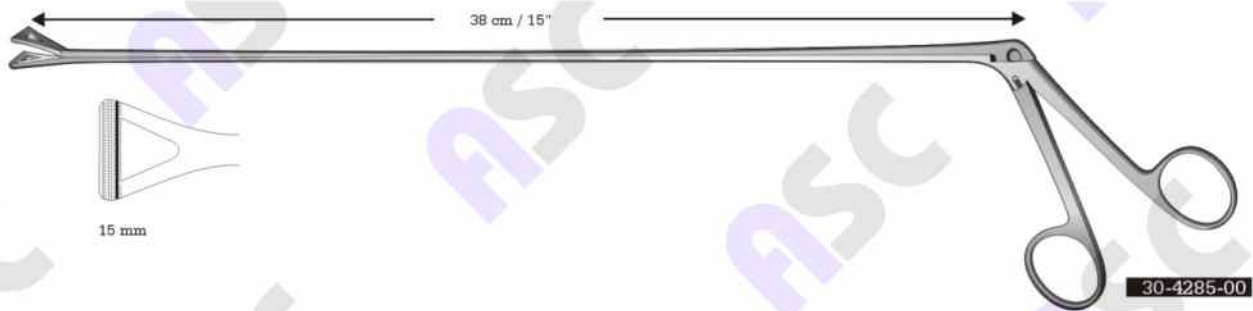

Rectal Forcep, Grooved Directors
Mastdarmzangen, Hohlsonden
Pinzas clamps rectales, Sondas acanaladas

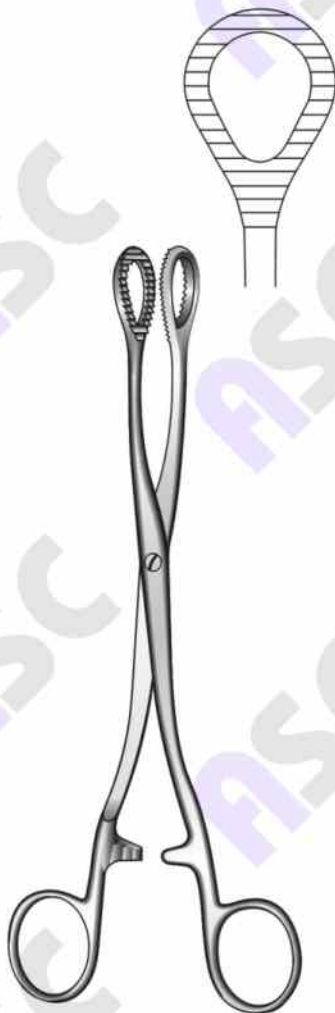

Heywood-Smith
30-4310-20
20 cm / 8"

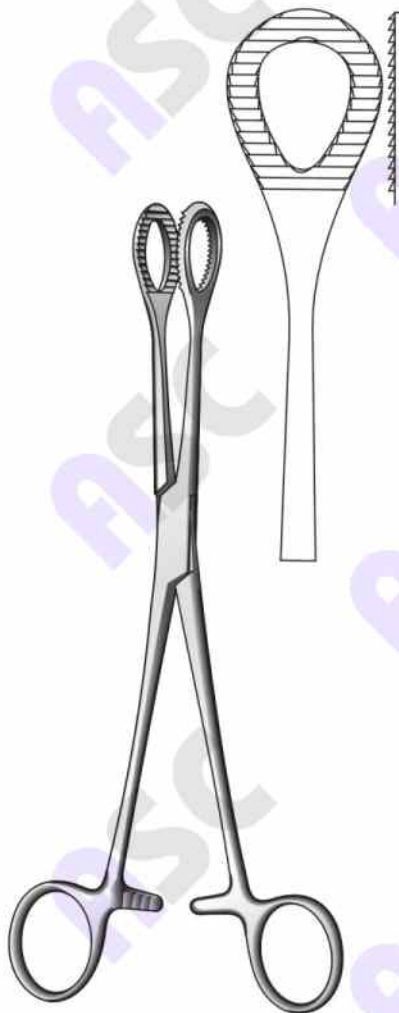

Heywood-Smith
30-4315-21
21 cm / 8 1/4"

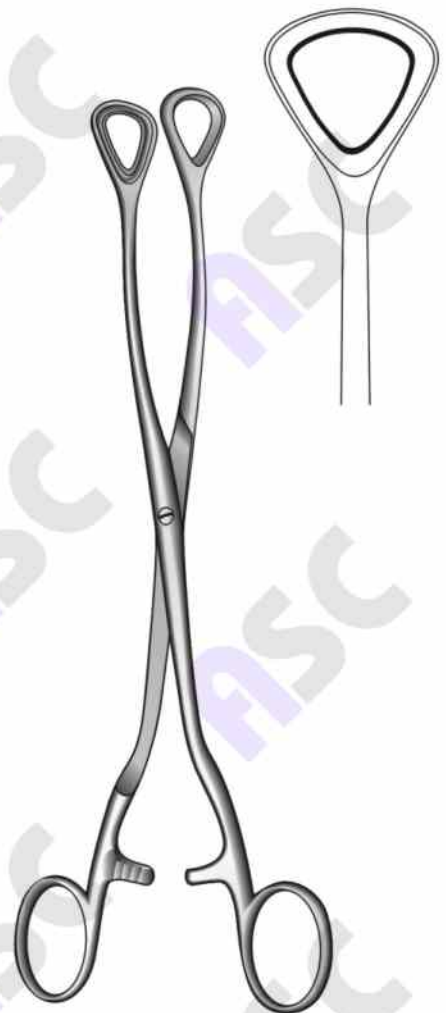

Leur
30-4320-24
24.5 cm / 9 1/2"



Larry
30-4325-18
18 cm / 7"



Barr
30-4330-29
29 cm / 11 1/2"
Fistula probe



Buie
30-4335-17
17 cm / 6 1/4"



Pratt
30-4340-28
28 cm / 11"



Barr
30-4345-18
18 cm / 7"



Blanchard
30-4350-17
17 cm / 6 1/4"



Barr
30-4355-25
25 cm / 10"



Pratt
22 cm / 8 1/2"



30-4360-22
Narrow



30-4361-22
Short



30-4362-22
Long



Stewart
30-4365-22 Short
30-4366-22 Long
22 cm / 8 1/2"



Rossor
30-4370-17
17 cm / 6 1/4"

Kidney Stone Forceps
Nierensteinzangen
Pinzas para cálculos renales



Randall
19 cm / 7½"

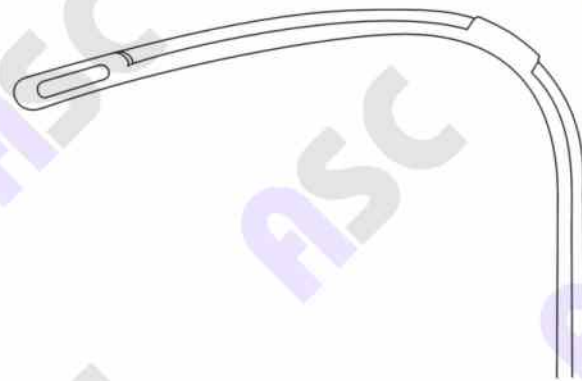

31-3001-19
Fig. 2

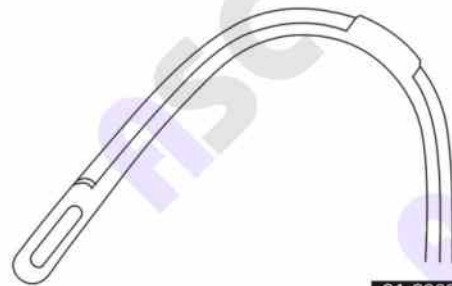

31-3002-19
Fig. 1

Kidney Stone Forceps
Nierensteinzangen
Pinzas para cálculos renales



Gall Stone Forceps
Gallensteinzangen
Pinzas para cálculos biliares



Blake
31-3025-20
20 cm / 8"

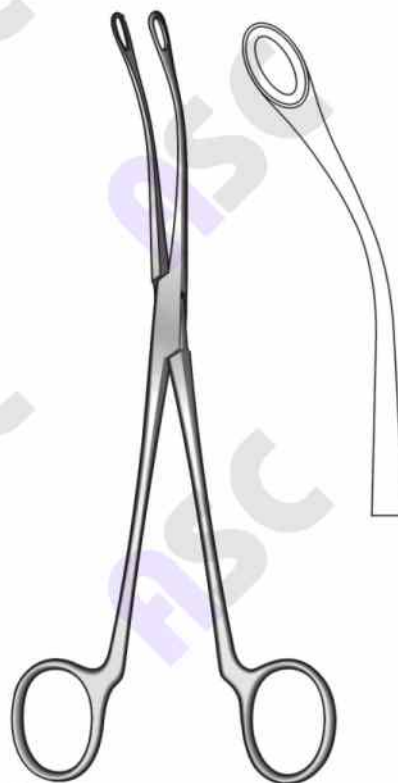

Blake
31-3030-20
20 cm / 8"



Mayo-Blake
31-3035-20
20 cm / 8"



Mayo-Blake
31-3040-20
20 cm / 8"



Mixer
31-3045-22
22 cm / 8 3/4"



31-3050-23



31-3051-23



Desjardins
23 cm / 9"



Desjardins
23 cm / 9"



31-3055-23



31-3056-23



31-3057-23



31-3058-23

Gall Stone Forceps
Gallensteinzangen
Pinzas para cálculos biliares

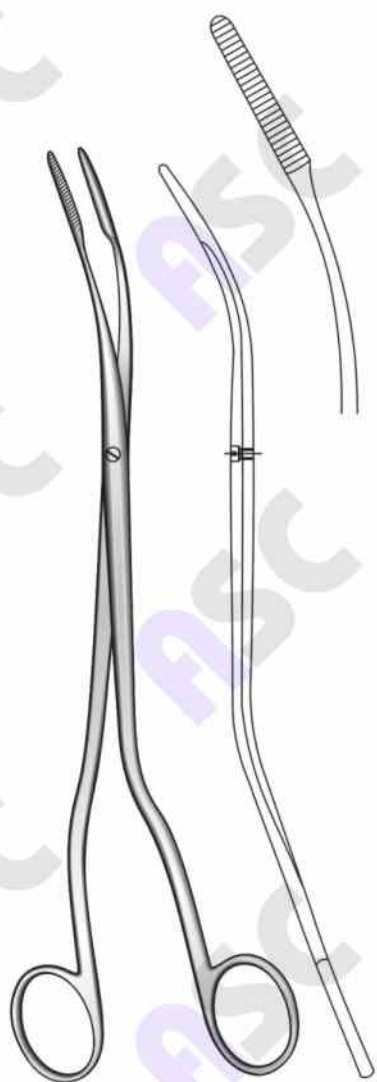

Czerny
31-3065-24
24.5 cm / 9 3/4"



31-3060-21
21 cm / 8 1/4"

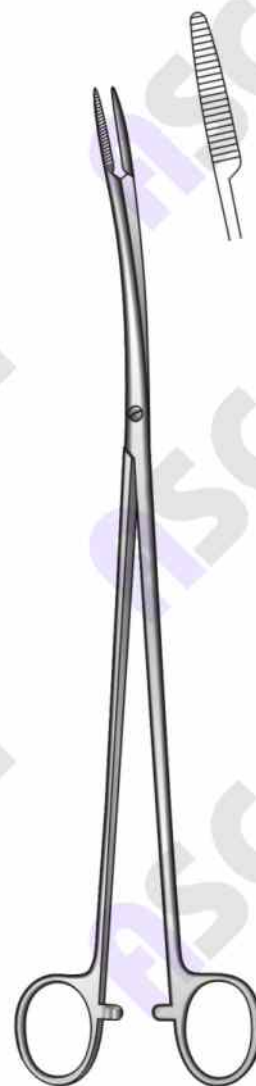

Pelkmann
31-3070-26
26 cm / 10 1/4"



Stille
31-3080-24
24.5 cm / 9 1/2"



Tubinger-Modell
31-3075-25
25 cm / 10"



31-3085-23
23 cm / 9"
Over street forceps

Nephrostomy Forceps
Nierenfistelzangen
Pinzas para nefrostomia

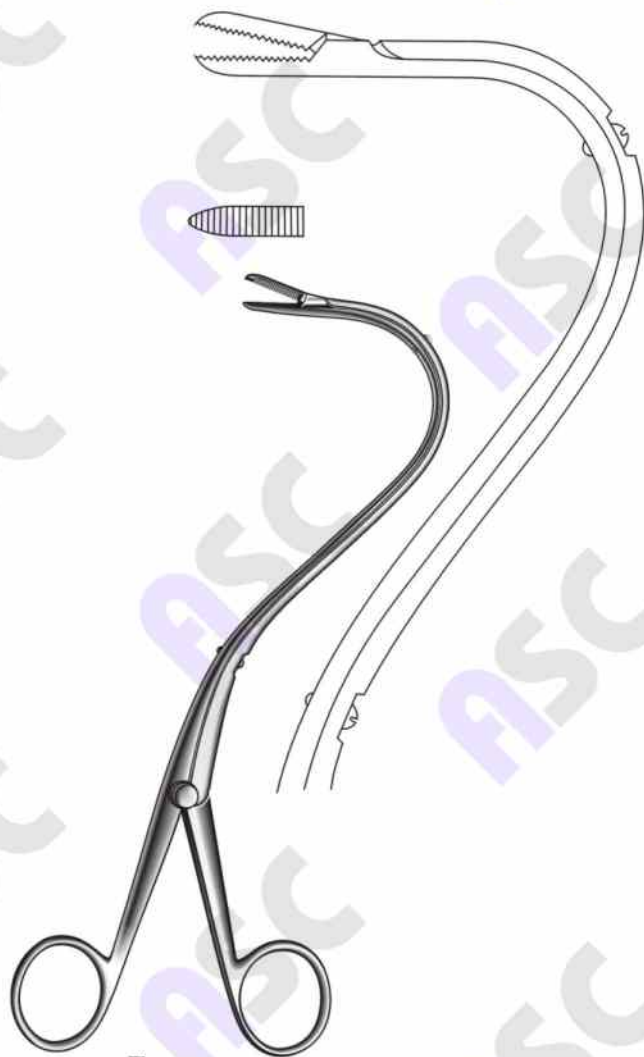

Elsasser
31-3090-20
20 cm / 8"
Fig. 1

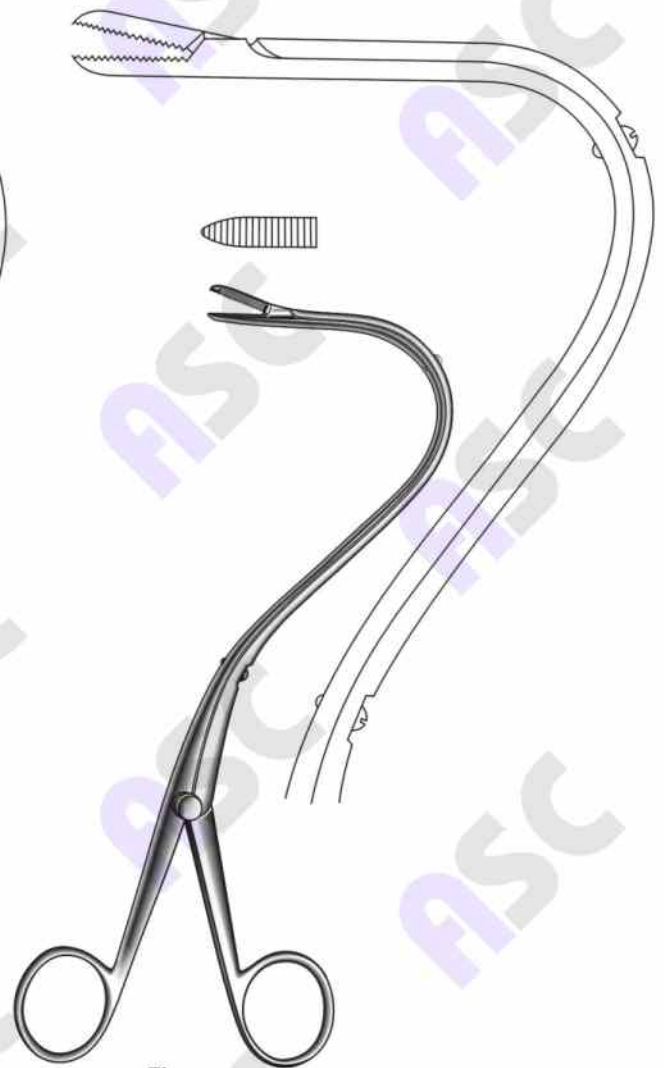

Elsasser
31-3095-20
20 cm / 8"
Fig. 2



Mayo
31-3101-32
32 cm / 12 3/4"



Bakes
31-3105-30
30 cm / 12"
Set of 13

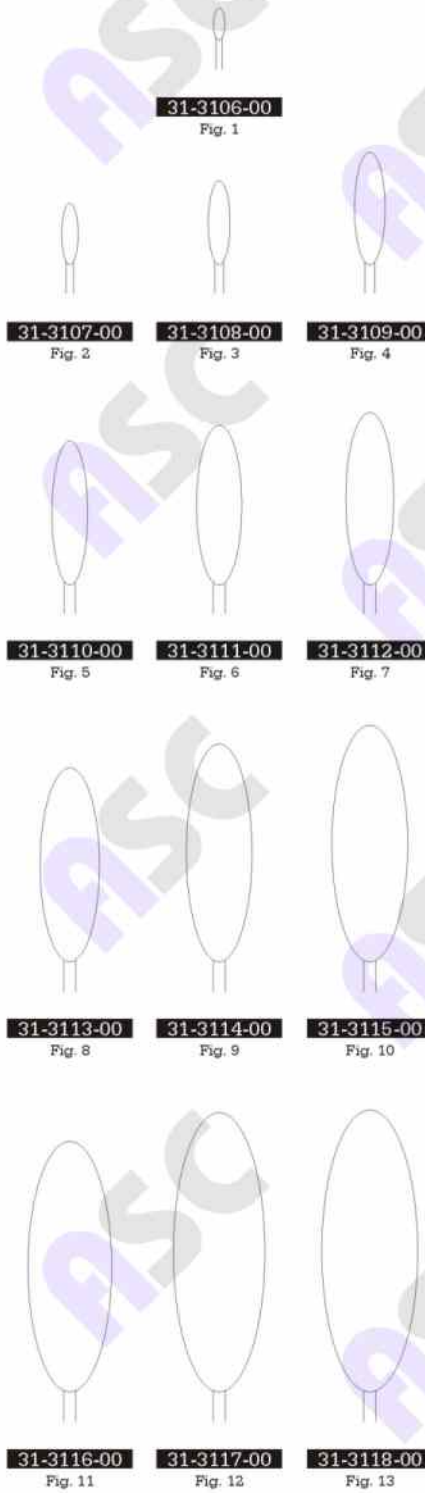

Desjardins
31-3120-28
28 cm / 11"
Elastic



Gall Stone Probes, Gall Stone Scoops
Gallensteinsonden, Gallensteinlöffel
Exploradores para cálculos biliares, Cucharillas para coger cálculos biliares





Luer-Koerte
32 cm / 12 3/4"



31-3150-32
2.5 mm
Fig. 000



31-3152-32
4.2 mm
Fig. 0



31-3154-32
6.7 mm
Fig. 2



31-3156-32
11 mm
Fig. 4



31-3151-32
3.2 mm
Fig. 00



31-3153-32
5.5 mm
Fig. 1



31-3155-32
8.0 mm
Fig. 3



31-3157-32
15 mm
Fig. 5



31-3160-30



31-3161-30



31-3162-30



31-3163-30



31-3164-30



Muenchen Model
30 cm / 12"

Prostatic Retractors
Prostatahaken
Separadores para la prostata



Young
31-3170-21
21.5 cm / 8½"

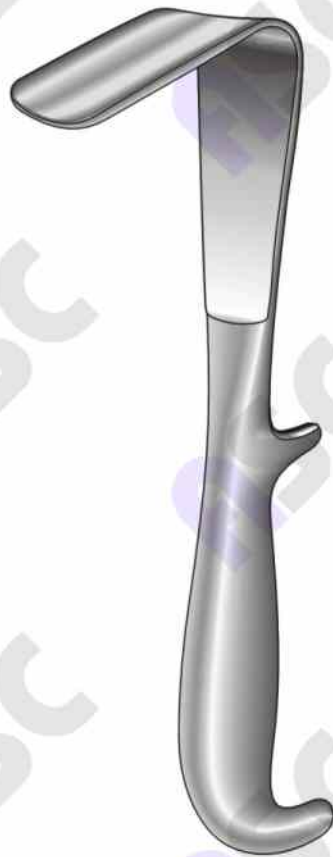

Young
31-3175-21
21 cm / 8½"



Young
31-3180-22
22 cm / 8¾"



Young
31-3185-21
21 cm / 8½"

Capsule Forceps
Kapselzangen
Pinzas capsulares

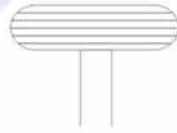

31-4005-23
23 cm / 9"



31-4006-23
23 cm / 9"

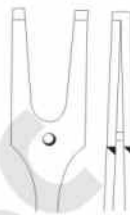

31-4007-24
24 cm / 9½"

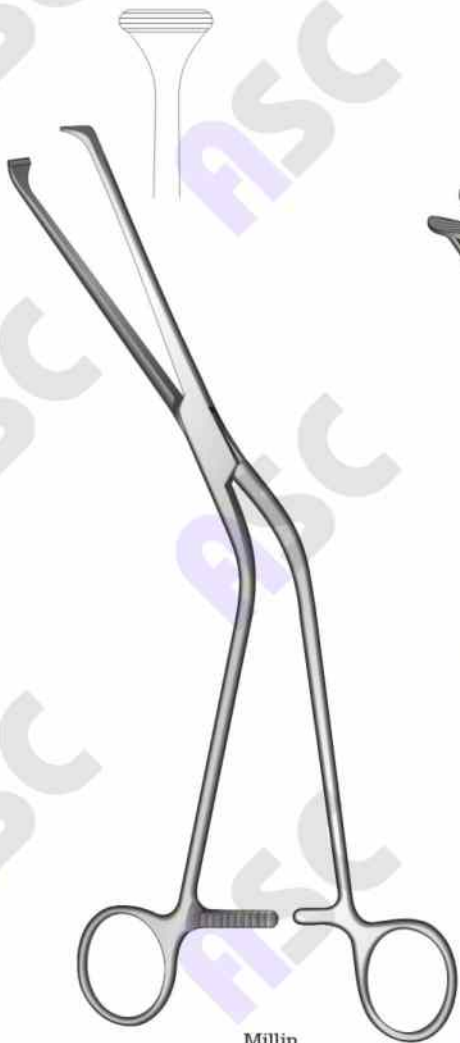

Millin
31-4001-24
24.5 cm / 9¾"



Millin



Millin
31-4010-23
23.5 cm / 9¼"

Bladder Retractors
Blasenwundsperrer
Separadores vesicales

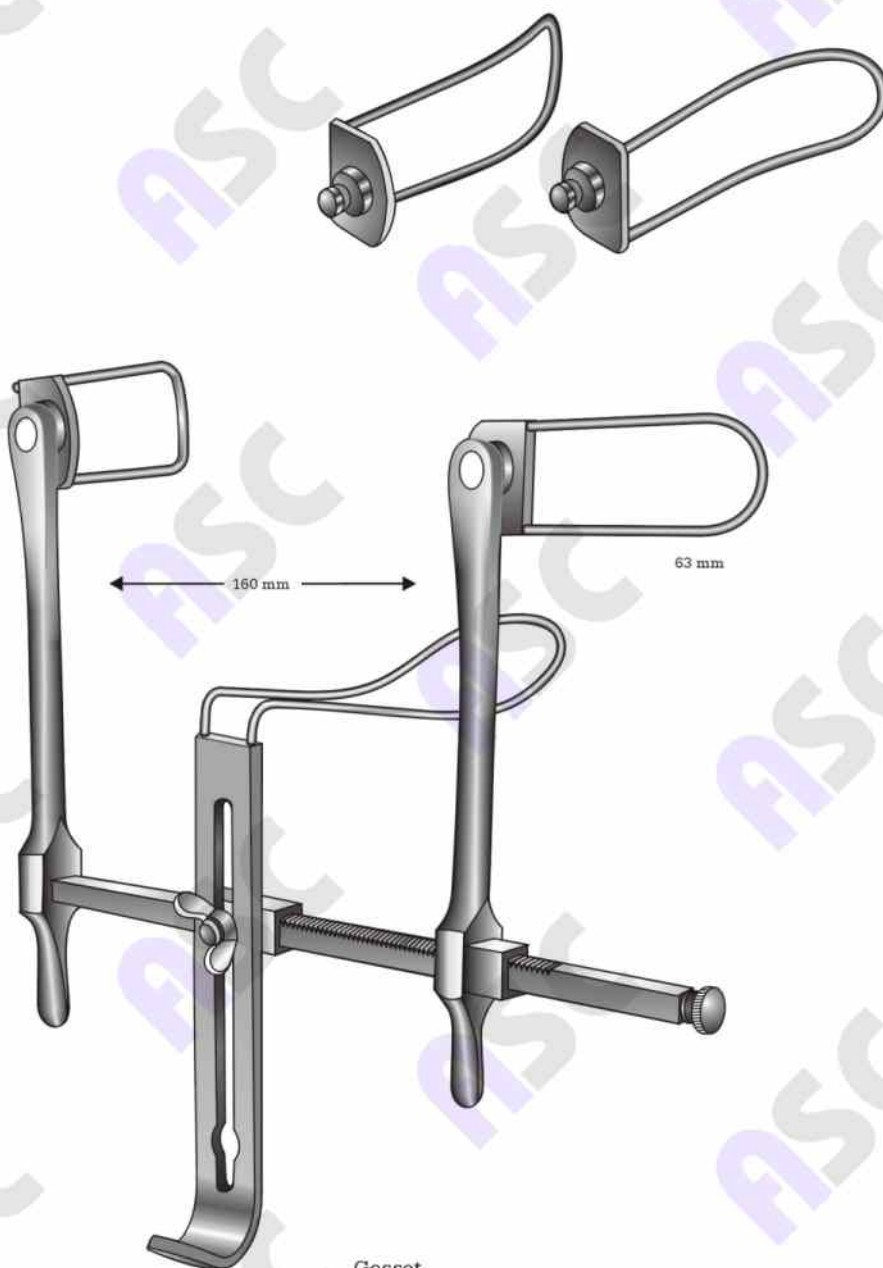

Gosset
31-4015-00

Bladder Neck Spreaders
Blasenhalsperrer
Dilatadores para el cuello vesical



Millin
31-4020-00



Millin
31-4025-00
29 cm / 11½"



Millin
31-4030-00

Bladder Retractors
Blasenwundsperrer
Separadores vesicales

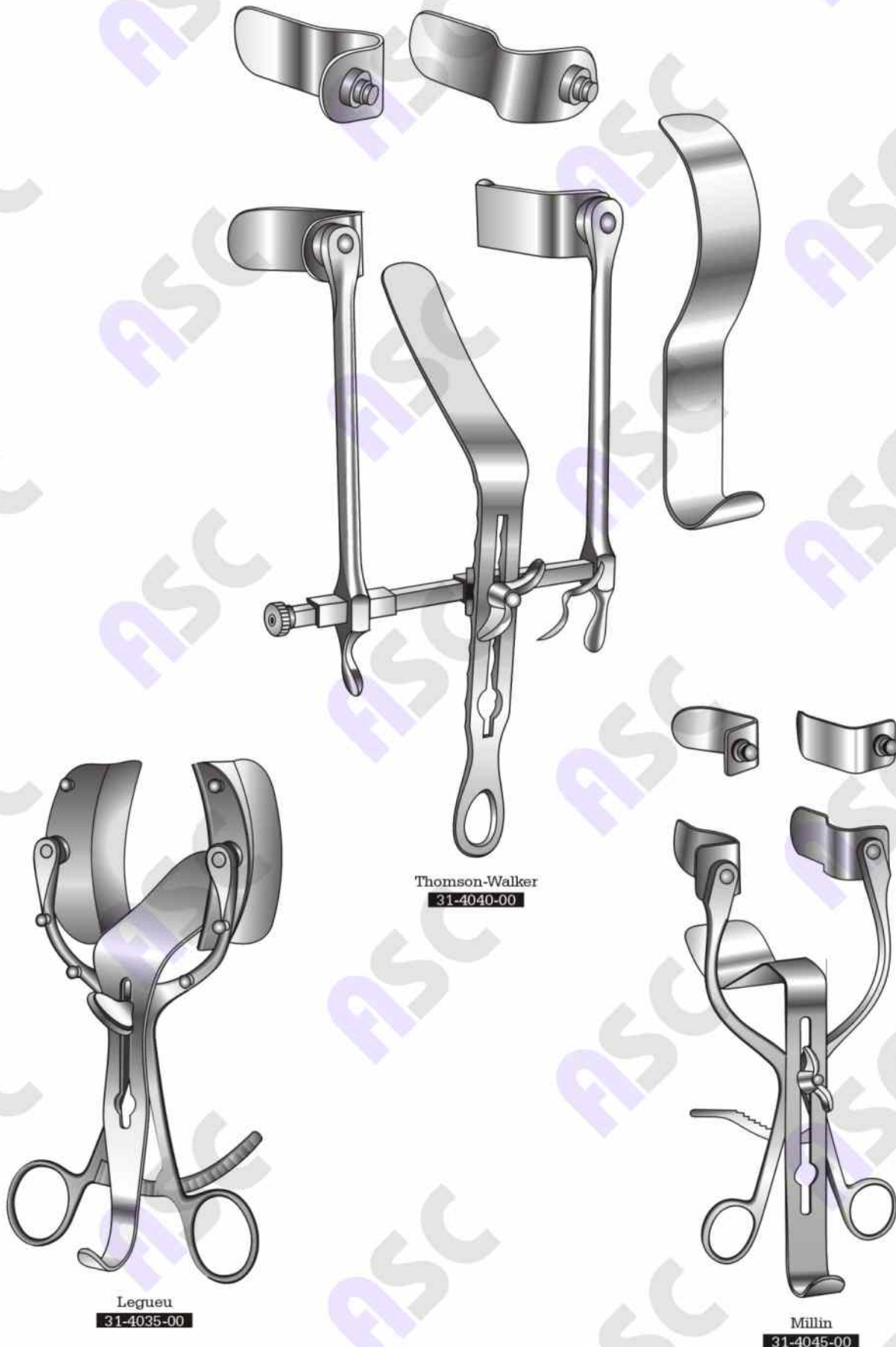

Bladder Retractors
Blasenwundsperrer
Separadores vesicales



35 mm

Legueu
31-4050-27
27 cm / 10 $\frac{1}{2}$ "



56 mm

Kocher
31-4055-26
26 cm / 10 $\frac{1}{4}$ "



67 mm

Kocher
31-4060-26
26 cm / 10 $\frac{1}{4}$ "

Foreign Body Forceps, Circumcision Instruments
 Fremdkörperzangen, Zirkumzisions Instrumente
 Pinzas para cuerpos extraños, Circuncision



Mathieu
31-4065-20 20 cm / 8"
31-4065-28 28 cm / 11"



Mathieu
31-4070-20 20 cm / 8"
31-4070-28 28 cm / 11"



Mogen
31-4075-07
 7 cm / 2 3/4"



31-4080-16
 16 cm / 6 1/4"

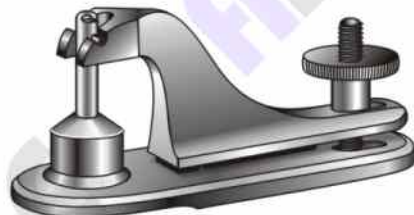

31-4085-00 8 mm Ø
31-4086-00 11 mm Ø
31-4087-00 13 mm Ø
31-4088-00 16 mm Ø
31-4089-00 21 mm Ø
31-4090-00 26 mm Ø
31-4091-00 32 mm Ø



Winkelmann
31-4095-00 12 mm Ø
31-4096-00 16 mm Ø
31-4097-00 20 mm Ø
 Circumcision clamps

Hernia Directors, Suction Tube
Sonden, Absaugkanülen
Sondas, Cánulas de aspiración



Child
31-4101-00



Key
31-4105-00



Teale
31-4110-00



Millin
31-4115-00

Lithotomy Forceps, Meatus Clamps
Steinzangen, Penisklemmen
Pinza para litotomia, Compresores uretrales



Lewkowitz
31-4120-26
26 cm / 10 1/4"



31-4121-26
Angled

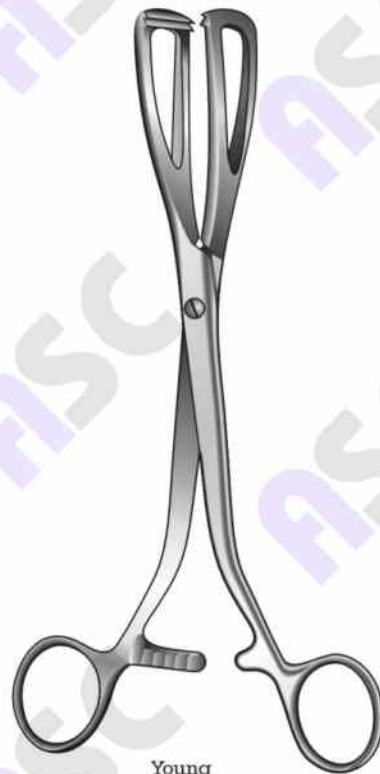

Young
31-4125-20
20 cm / 8"



Thomson-Walker
31-4130-00



Stockmann
31-4135-00



Strauss
31-4140-00

Dilating Bougie
Dilatationsbougies
Bujías dilatadoras



	Fr.
31-4146-00	00/1
31-4147-00	0/2
31-4148-00	1/3
31-4149-00	1/4
31-4150-00	2/5
31-4151-00	3/6
31-4152-00	4/7
31-4153-00	5/8
31-4154-00	6/9
31-4155-00	7/10
31-4156-00	8/11
31-4157-00	9/12
31-4158-00	10/13
31-4159-00	11/14
31-4160-00	12/15
31-4161-00	13/16
31-4162-00	14/17
31-4163-00	15/18

Lister
31-4145-00
Set



	Fr.
31-4166-00	6/10
31-4167-00	8/12
31-4168-00	10/14
31-4169-00	12/16
31-4170-00	14/18
31-4171-00	16/20
31-4172-00	18/22
31-4173-00	20/24
31-4174-00	22/26
31-4175-00	24/28
31-4176-00	26/30
31-4177-00	28/32

Clutton
31-4165-00
Set



	Fr.
31-4255-00	08
31-4256-00	09
31-4257-00	10
31-4258-00	11
31-4259-00	12
31-4260-00	13
31-4261-00	14
31-4262-00	15
31-4263-00	16
31-4264-00	17
31-4265-00	18
31-4270-00	19
31-4271-00	20
31-4272-00	21
31-4273-00	22
31-4274-00	23
31-4275-00	24
31-4276-00	25
31-4277-00	26
31-4278-00	27
31-4279-00	28
31-4280-00	29
31-4285-00	30
31-4286-00	31
31-4287-00	32
31-4288-00	33
31-4289-00	34
31-4290-00	35
31-4291-00	36

Ven Buren
31-4250-00
Set



	Fr.
31-4240-00	06
31-4241-00	08
31-4242-00	10
31-4243-00	12



Dittel
31-4245-00
Set

	Fr.
31-4400-00	8
31-4401-00	9
31-4402-00	10
31-4403-00	11
31-4404-00	12
31-4405-00	13
31-4406-00	14
31-4407-00	15
31-4408-00	16
31-4409-00	17
31-4410-00	18
31-4411-00	19
31-4412-00	20
31-4413-00	21
31-4414-00	22
31-4415-00	23
31-4416-00	24
31-4417-00	25
31-4418-00	26
31-4419-00	27
31-4420-00	28
31-4421-00	29
31-4422-00	30

Dilating Bougie
 Dilatationsbougies
 Bujías dilatadoras



Guyon

	Fr.	
31-4181-00	8	31-4210-00
31-4182-00	9	31-4211-00
31-4183-00	10	31-4212-00
31-4184-00	11	31-4213-00
31-4185-00	12	31-4214-00
31-4186-00	13	31-4215-00
31-4187-00	14	31-4216-00
31-4188-00	15	31-4217-00
31-4189-00	16	31-4218-00
31-4190-00	17	31-4219-00
31-4191-00	18	31-4220-00
31-4192-00	19	31-4221-00
31-4193-00	20	31-4222-00
31-4194-00	21	31-4223-00
31-4195-00	22	31-4224-00
31-4196-00	23	31-4225-00
31-4197-00	24	31-4226-00
31-4198-00	25	31-4227-00
31-4199-00	26	31-4228-00
31-4200-00	27	31-4229-00
31-4201-00	28	31-4230-00
31-4202-00	29	31-4231-00
31-4203-00	30	31-4232-00
31-4207-00	31	31-4236-00
31-4204-00	32	31-4233-00
31-4208-00	33	31-4237-00
31-4205-00	34	31-4234-00
31-4209-00	35	31-4238-00
31-4206-00	36	31-4235-00

Without hole

With hole



Guyon
31-4180-01 Set of 29; Fig. 8 - Fig. 36
 with hole
31-4180-02 Set of 29; Fig. 8 - Fig. 36
 without hole



Male

- 31-4295-27 Fig. 06
- 31-4296-27 Fig. 07
- 31-4297-27 Fig. 08
- 31-4298-27 Fig. 09
- 31-4299-27 Fig. 10
- 31-4300-27 Fig. 11
- 31-4301-27 Fig. 12
- 31-4302-27 Fig. 13
- 31-4303-27 Fig. 14
- 31-4304-27 Fig. 15
- 31-4305-27 Fig. 16
- 31-4306-27 Fig. 17
- 31-4307-27 Fig. 18
- 31-4308-27 Fig. 19
- 31-4309-27 Fig. 20
- 31-4310-27 Fig. 21
- 31-4311-27 Fig. 22
- 31-4312-27 Fig. 23
- 31-4313-27 Fig. 24

27 cm / 10½"



Coxeter

- 31-4320-28 Fig. 06
- 31-4321-28 Fig. 07
- 31-4322-28 Fig. 08
- 31-4323-28 Fig. 09
- 31-4324-28 Fig. 10
- 31-4325-28 Fig. 11
- 31-4326-28 Fig. 12
- 31-4327-28 Fig. 13
- 31-4328-28 Fig. 14
- 31-4329-28 Fig. 15
- 31-4330-28 Fig. 16
- 31-4331-28 Fig. 17
- 31-4332-28 Fig. 18
- 31-4333-28 Fig. 19
- 31-4334-28 Fig. 20
- 31-4335-28 Fig. 21
- 31-4336-28 Fig. 22
- 31-4337-28 Fig. 23
- 31-4338-28 Fig. 24

28 cm / 11"



Female

- 31-4340-15 Fig. 06
- 31-4341-15 Fig. 07
- 31-4342-15 Fig. 08
- 31-4343-15 Fig. 09
- 31-4344-15 Fig. 10
- 31-4345-15 Fig. 11
- 31-4346-15 Fig. 12
- 31-4347-15 Fig. 13
- 31-4348-15 Fig. 14
- 31-4349-15 Fig. 15
- 31-4350-15 Fig. 16
- 31-4351-15 Fig. 17
- 31-4352-15 Fig. 18
- 31-4353-15 Fig. 19
- 31-4354-15 Fig. 20
- 31-4355-15 Fig. 21
- 31-4356-15 Fig. 22
- 31-4357-15 Fig. 23
- 31-4358-15 Fig. 24

15 cm / 6"



Female

- 31-4360-20 Fig. 06
- 31-4361-20 Fig. 07
- 31-4362-20 Fig. 08
- 31-4363-20 Fig. 09
- 31-4364-20 Fig. 10
- 31-4365-20 Fig. 11
- 31-4366-20 Fig. 12
- 31-4367-20 Fig. 13
- 31-4368-20 Fig. 14
- 31-4369-20 Fig. 15
- 31-4370-20 Fig. 16
- 31-4371-20 Fig. 17
- 31-4372-20 Fig. 18
- 31-4373-20 Fig. 19
- 31-4374-20 Fig. 20
- 31-4375-20 Fig. 21
- 31-4376-20 Fig. 22
- 31-4377-20 Fig. 23
- 31-4378-20 Fig. 24

20 cm / 8"

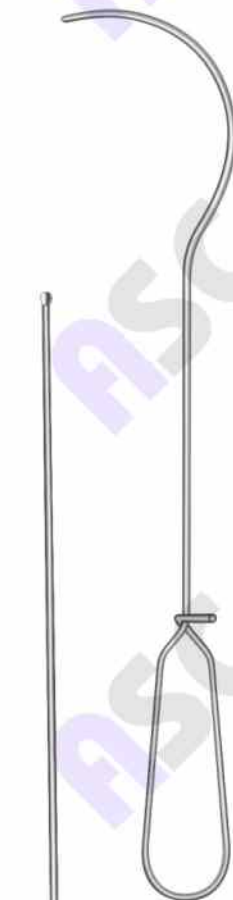

31-4385-35
35 cm / 13¾"

Guyon

31-4380-39
39 cm / 15½"

Vaginal Specula
Scheidenspekula
Espéculos vaginales



Cusco
32-3001-00 75 x 32 mm
32-3002-00 88 x 35 mm
32-3003-00 100 x 37 mm
 Central screw, swiss pattern



Cusco
32-3005-00 90 x 22 mm
32-3006-00 100 x 25 mm
32-3007-00 105 x 27 mm
 Swiss pattern



Cusco
32-3010-00 75 x 32 mm
32-3011-00 85 x 35 mm
32-3012-00 100 x 37 mm
 With close end



Cusco
32-3015-00
 75 x 17 mm



Trelat
32-3020-00 85 x 33 mm
32-3021-00 95 x 35 mm
32-3022-00 115 x 43 mm



Cusco
 Japanese model
32-3025-00 Small
32-3026-00 Medium
32-3027-00 Large
 Stainless steel forged handle
32-3030-00 Small
32-3031-00 Medium
32-3032-00 Large
 Stainless steel sheet handle

Vaginal Specula
Scheidenspekula
Espéculos vaginales



Clum
32-3035-00
Sakurai's vaginal speculum



Cusco
32-3040-00 Small
32-3041-00 Medium
32-3042-00 Large

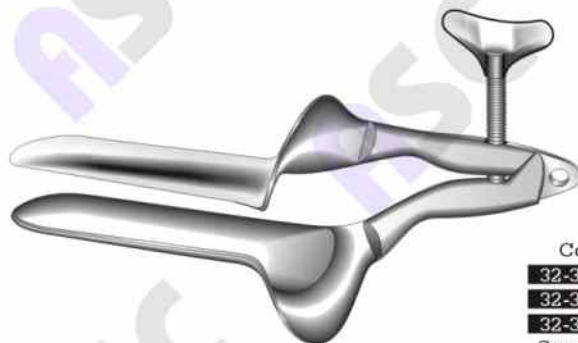

Collin
32-3045-00 65 x 30 mm
32-3046-00 100 x 35 mm
32-3047-00 110 x 40 mm
German sizes
32-3050-00 16 x 90 mm
32-3051-00 26 x 90 mm
32-3052-00 30 x 90 mm
32-3053-00 32 x 105 mm
32-3054-00 35 x 105 mm
32-3055-00 38 x 105 mm
French sizes

Vaginal Specula
Scheidenspekula
Especulos vaginales



Cusco Pliant

32-3060-00	16 x 100 mm
32-3061-00	20 x 100 mm
32-3062-00	25 x 100 mm
32-3063-00	28 x 100 mm
32-3064-00	30 x 100 mm
32-3065-00	32 x 100 mm
32-3066-00	36 x 100 mm

Cusco Fixe

32-3070-00	16 x 100 mm
32-3071-00	25 x 100 mm
32-3072-00	32 x 100 mm
32-3073-00	35 x 100 mm
32-3074-00	40 x 100 mm



Pederson

32-3080-00	75 x 13 mm
32-3081-00	100 x 22 mm
32-3082-00	120 x 25 mm

Grave

32-3085-00	75 x 20 mm
32-3086-00	96 x 35 mm
32-3087-00	115 x 35 mm

Semm

32-3090-00	100 x 17 / 20 mm
32-3091-00	100 x 25 / 30 mm



Grave's Wide View

- 32-3095-00** Small
- 32-3096-00** Medium
- 32-3097-00** Large



VU-More
Grave



- VU-More
- 32-3101-00** Small
 - 32-3102-00** Medium
 - 32-3103-00** Large



Collin
32-3105-00
65 x 10 mm

Vaginal Specula
Scheidenspekula
Especulos vaginales



Grave
32-3120-00 76 x 13 mm
32-3121-00 101 x 22 mm
32-3122-00 120 x 35 mm
 Suction tubes on lower & upper blade

Grave
32-3115-00 76 x 13 mm
32-3116-00 101 x 22 mm
32-3117-00 120 x 35 mm
 Suction tube on lower blade

Grave
32-3110-00 76 x 13 mm
32-3111-00 101 x 22 mm
32-3112-00 120 x 35 mm
 Suction tube on upper blade

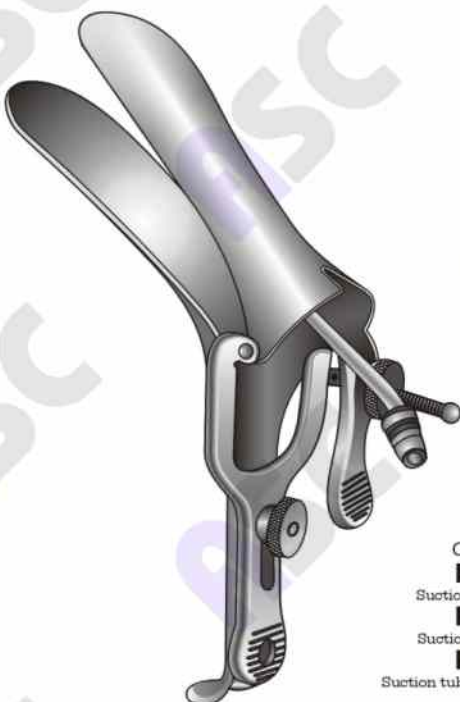

135° angled
101 x 35 mm
Grave Special
32-3125-00
 Suction tube on upper blade
32-3126-00
 Suction tube on lower blade
32-3127-00
 Suction tube on upper & lower blades



Right side open
101 x 35 mm
Grave Special
32-3130-00
 Suction tube on upper blade
32-3131-00
 Suction tube on lower blade
32-3132-00
 Suction tube on upper & lower blades

Vaginal Specula
 Scheidenspekula
 Espéculos vaginales

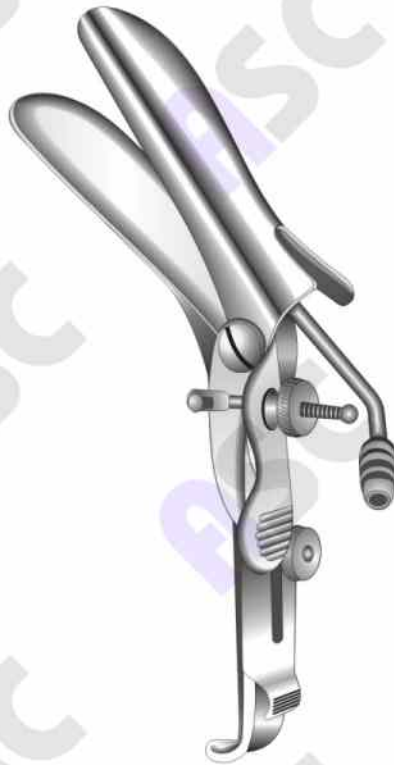

135° angled & right side open
 101 x 35 mm

Grave Special

32-3135-00

Suction tube on upper blade

32-3136-00

Suction tube on lower blade

32-3137-00

Suction tube on upper & lower blades



Guttmann

32-3140-00

80 x 45 mm



Guttmann

32-3145-00

90 x 35 mm

Vaginal Specula
Scheidenspekula
Espéculos vaginales



Sims

32-3150-00	65 x 25 mm, 75 x 30 mm
32-3151-00	70 x 30 mm, 70 x 35 mm
32-3152-00	85 x 35 mm, 90 x 40 mm

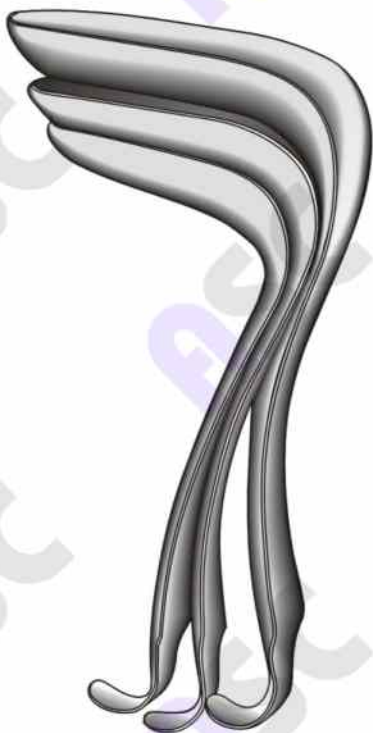

Kristeller

32-3155-00	70 x 27 mm
32-3156-00	80 x 30 mm
32-3157-00	90 x 36 mm

Specula



Kristeller

32-3160-00	75 x 23 mm
32-3161-00	85 x 26 mm
32-3162-00	100 x 32 mm

Retractors



Kristeller

32-3165-00	32-3155-00 & 32-3160-00
32-3166-00	32-3156-00 & 32-3161-00
32-3167-00	32-3157-00 & 32-3162-00

Set of 1 speculum and 1 retractor

Conically shaped blades, virgin sizes



32-3180-00 32-3170-00 & 32-3175-00
32-3181-00 32-3171-00 & 32-3176-00
Set of 1 speculum and 1 retractor

Kristeller

32-3170-00 105 x 18 mm

32-3171-00 105 x 21 mm

Specula

Kristeller

32-3175-00 110 x 14 mm

32-3176-00 110 x 17 mm

Retractors

Vaginal Specula
Scheidenspekula
Espéculos vaginales



Kristeller
32-3195-00 32-3185-00 & 32-3190-00
32-3196-00 32-3186-00 & 32-3191-00
32-3197-00 32-3187-00 & 32-3192-00
 Set of 1 speculum and 1 retractor

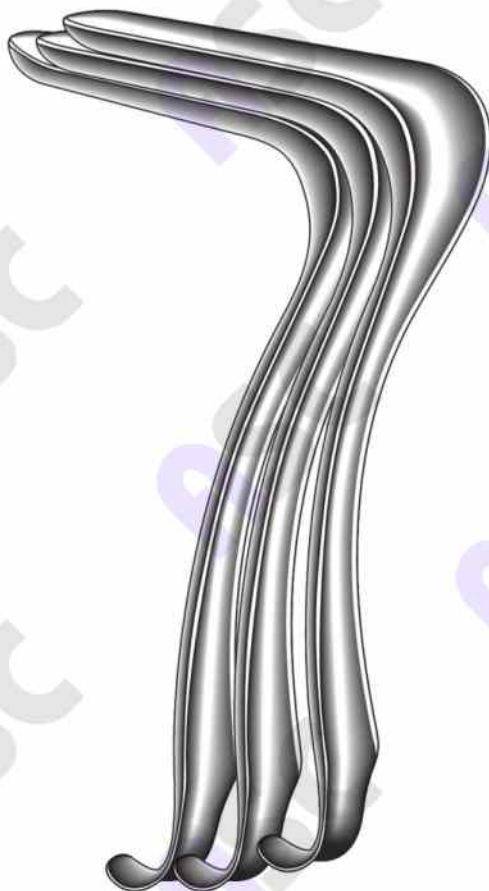

Kristeller
32-3185-00 105 x 26 mm
32-3186-00 105 x 28 mm
32-3187-00 105 x 33 mm
 Specula

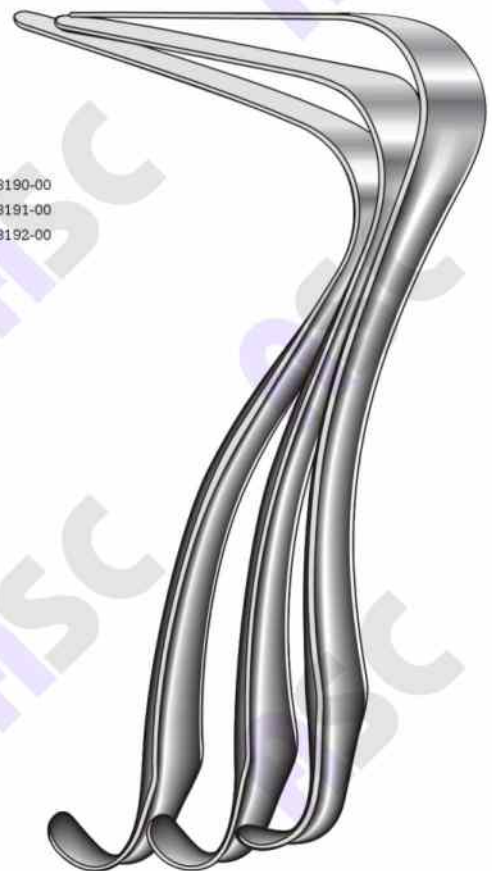

Kristeller
32-3190-00 115 x 22 mm
32-3191-00 115 x 24 mm
32-3192-00 115 x 29 mm
 Retractors



Specula deep hollow

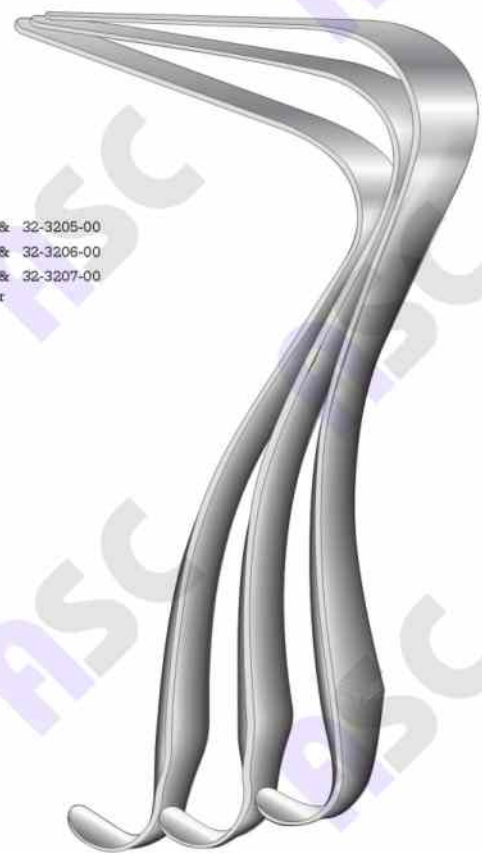
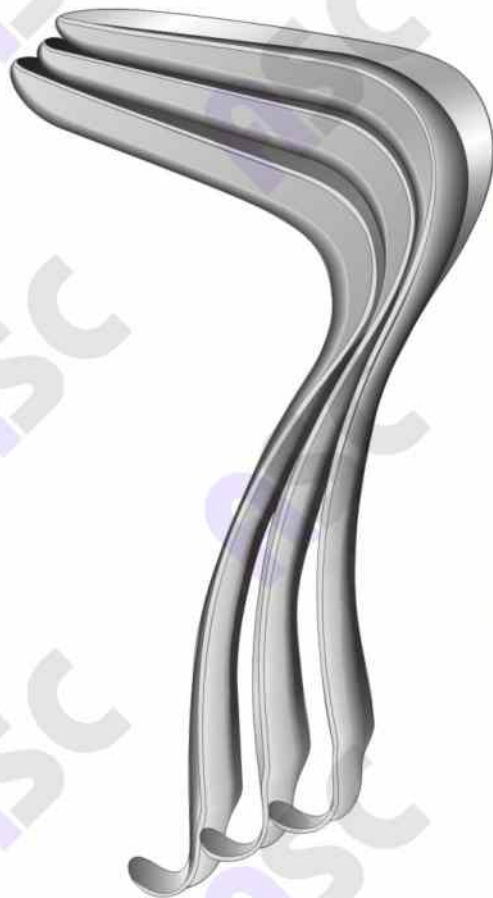

Kristeller

32-3210-00	32-3201-00 &	32-3205-00
32-3211-00	32-3202-00 &	32-3206-00
32-3212-00	32-3203-00 &	32-3207-00

Set of 1 speculum and 1 retractor

Kristeller

32-3201-00	110 x 27 mm
32-3202-00	110 x 30 mm
32-3203-00	110 x 36 mm

Specula

Kristeller

32-3205-00	115 x 23 mm
32-3206-00	115 x 26 mm
32-3207-00	115 x 32 mm

Retractors

Vaginal Specula
Scheidenspekula
Especulos vaginales

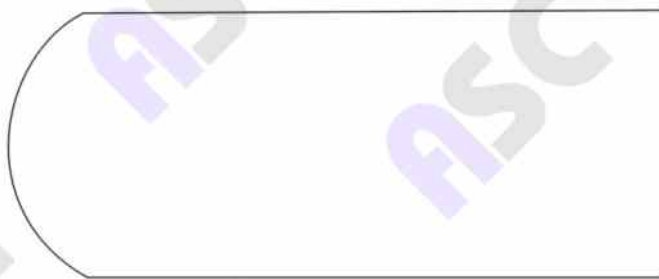

Doyen
Slightly-Concave
32-3215-00

32-3220-00	55 x 35 mm
32-3221-00	58 x 35 mm
32-3222-00	115 x 35 mm
32-3223-00	55 x 45 mm
32-3224-00	85 x 45 mm
32-3225-00	115 x 45 mm
32-3226-00	160 x 45 mm
32-3227-00	55 x 60 mm
32-3228-00	85 x 60 mm
32-3229-00	115 x 60 mm
32-3230-00	160 x 60 mm

Slightly-concave

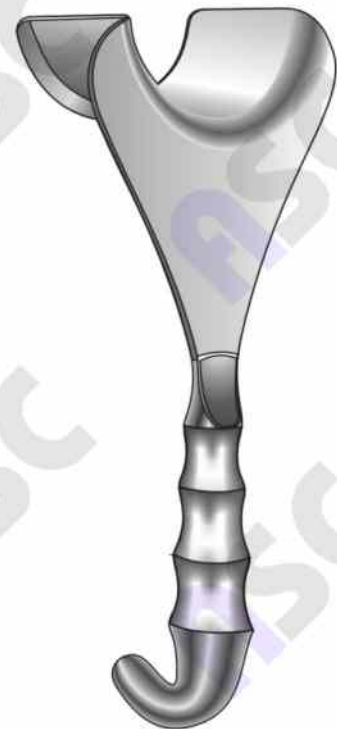

De Lee Universal Retractor
32-3235-24
24 cm / 9 1/2"
Blade 2 1/4" x 2"

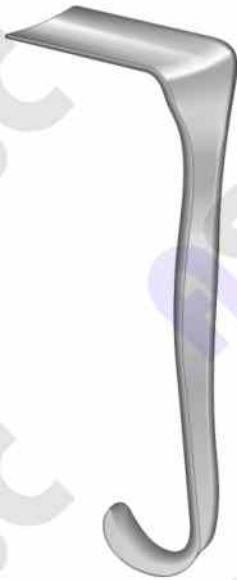

Jackson
32-3240-00
75 x 38 mm



Jackson
32-3245-00
90 x 38 mm



Jackson
32-3250-00
100 x 38 mm



Sims
32-3255-00
Single ended
32-3256-00 Small, 2 1/4" x 1"
32-3257-00 Medium, 3" x 1 1/4"
32-3258-00 Large, 3 1/2" x 1 1/4"

Vaginal Specula
Scheidenspekula
Espéculos vaginales



Kallmorgen
32-3260-00 70 x 40 mm
32-3261-00 90 x 40 mm
Vaginal specula



Kallmorgen
32-3265-00
32-3266-00
Vaginal retractors
32-3270-00 32-3260-00 & 32-3265-00
32-3271-00 32-3261-00 & 32-3266-00
Kallmorgen set



Mathieu
32-3275-00 95 x 16 mm
32-3276-00 95 x 26 mm
32-3277-00 95 x 16 mm
32-3278-00 95 x 30 mm
Vaginal specula



32-3280-00 100 x 16 mm
32-3281-00 100 x 20 mm
32-3282-00 100 x 14 mm
32-3283-00 100 x 26 mm
Vaginal retractors



Breisky

32-3285-00	100 x 20 mm
32-3286-00	100 x 25 mm
32-3287-00	100 x 30 mm
32-3288-00	100 x 35 mm
32-3289-00	100 x 40 mm
32-3290-00	130 x 20 mm
32-3291-00	130 x 25 mm
32-3292-00	130 x 30 mm
32-3293-00	130 x 35 mm
32-3294-00	130 x 40 mm
32-3295-00	155 x 40 mm



Doyen

32-3301-00
70 x 30 mm

Vaginal Specula
Scheidenspekula
Espéculos vaginales



Auvard

32-3305-00 Light 2 lbs.
32-3306-00 Medium 2½ lbs.
32-3307-00 Heavy 3 lbs
Weighted vaginal speculum
Blades 2¾" x 1½"



Garrigue

32-3310-00 Light 2 lbs.
32-3311-00 Medium 2½ lbs.
32-3312-00 Heavy 3 lbs.
Weighted vaginal speculum
Blades 3" x 1½"

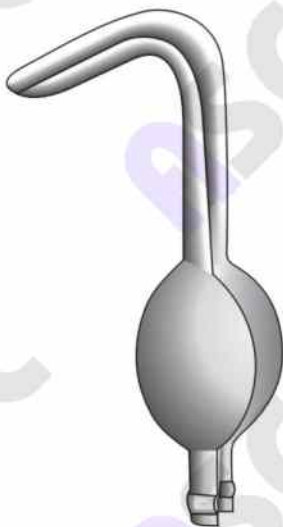

Henrotin

32-3315-00
3 lbs.
Blade 3¾" x 1½"
Weighted vaginal speculum

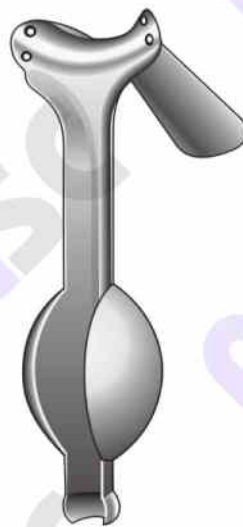

Berlind-Auvard

32-3320-00
2½ lbs.
Weighted vaginal speculum



Steiner-Auvard

32-3325-00
2½ lbs.
Weighted vaginal speculum



Jayle
32-3330-00 60 x 40 mm, 60 x 40 mm
32-3331-00 90 x 40 mm, 90 x 40 mm
Blade with weight



Soonawala
Vaginal specula
32-3335-00
Stainless steel



Soonawla Modified
Vaginal specula
32-3340-00
Stainless steel

Vaginal Specula
Scheidenspekula
Espéculos vaginales

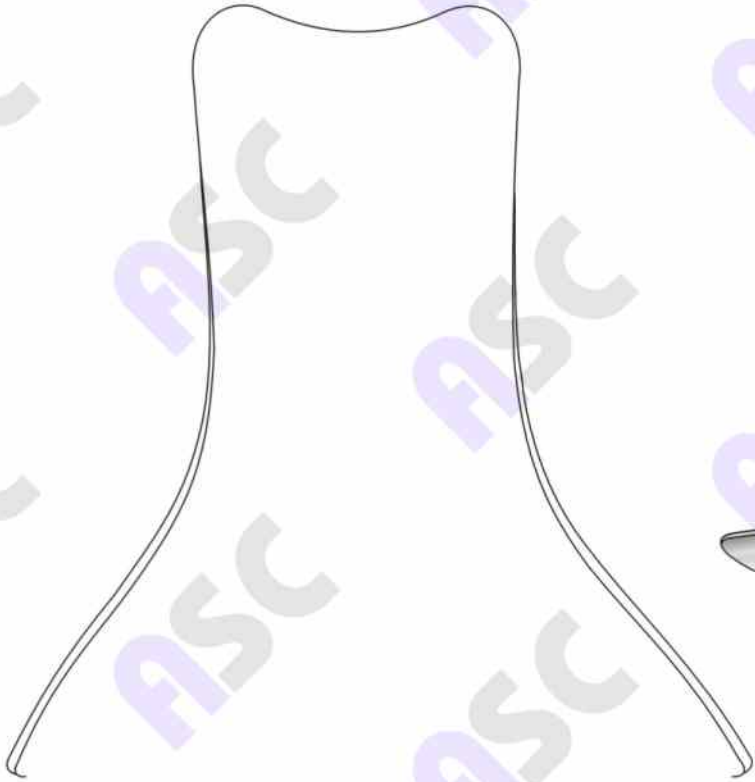

Auvard

32-3345-00

80 x 43 mm

Complete with removable weight



32-3365-00
80 x 30 mm



32-3366-00
85 x 35 mm



32-3370-00
55 x 40 mm, 60 mm



32-3367-00
85 x 40 mm
Special blade, only



32-3371-00
70 x 45 mm, 70 mm
Special blade, only

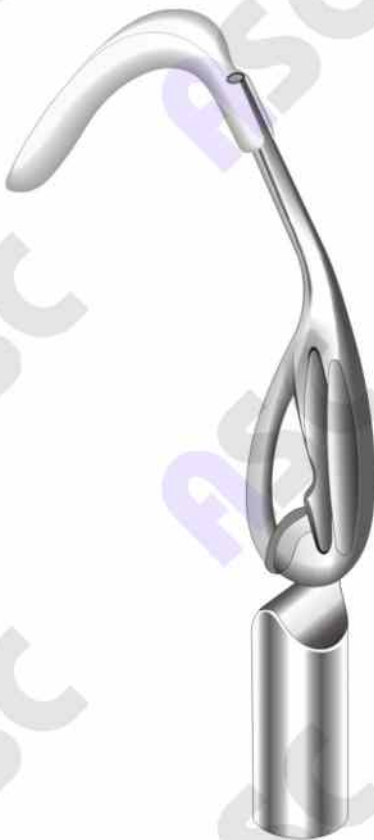

32-3355-00
Handle for vaginal speculum

32-3360-00
Weight for vaginal speculum

Scherback
32-3350-00
Set, consisting of
Handle (32-3355-00)
Weight (32-3360-00)
5 blades (32-3365-00 - 32-3371-00)

Vaginal Specula
Scheidenspekula
Espéculos vaginales



Bozemann
32-3375-23
23 cm / 9"

Bozemann
32-3380-22
22 cm / 8 1/4"



32-3376-00
80 x 30 mm



32-3381-22
65 x 30 mm



32-3377-00
85 x 33 mm



32-3382-00
75 x 35 mm



32-3378-00
100 x 38 mm



32-3383-00
85 x 35 mm



32-3379-00
110 x 42 mm



32-3384-00
95 x 35 mm

Bozemann
Set, consisting of
2 handle (32-3375-23 - 32-3380-22)
8 blades (32-3376-00 - 32-3384-00)



Lateral vaginal retractor

32-3385-00

Ratchet handle

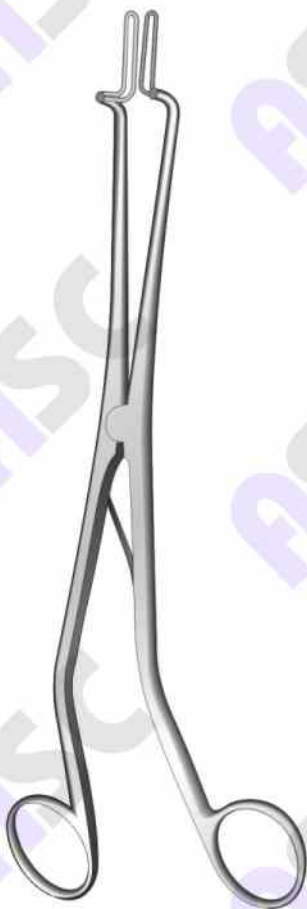

Kogan

32-3390-24

24 cm / 9½"



7 mm

Kogan

32-3395-24

24 cm / 9½"

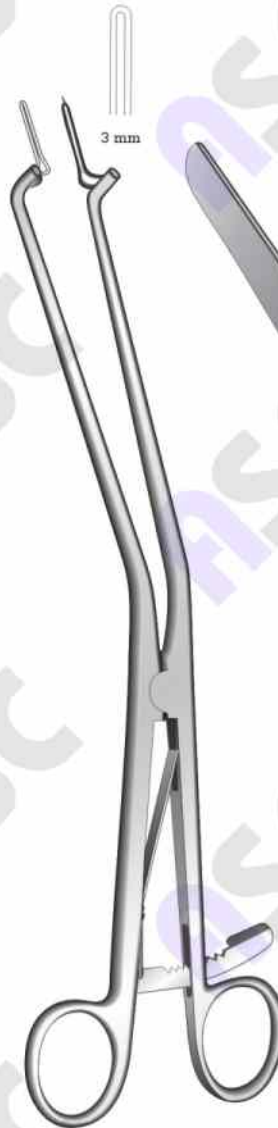

3 mm

Kogan

32-3401-18

18 cm / 11"



Lateral Vaginal Retractor

Blade size

32-3405-00 60 x 22 mm

32-3406-00 80 x 22 mm

32-3407-00 100 x 22 mm

32-3408-00 120 x 22 mm

With ratchet handle

Endospecula
Endospekula
Endospéculos

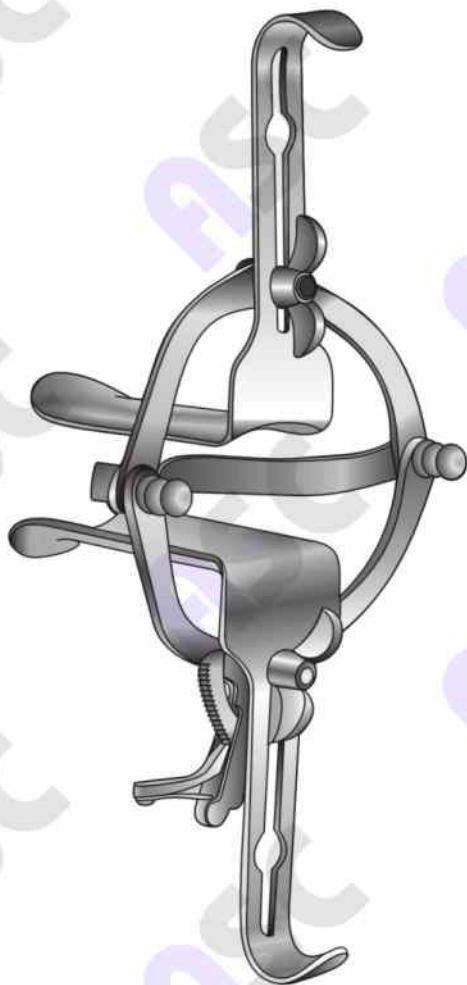

O' Sullivan-O' Connor
32-3415-00



Smith
32-3410-00

Vaginal retractor self-retaining provides adequate exposure for the obstetrical to work on the ante or post mortem cervix without an assistant. Stainless steel ring is 23 cm / 9" in diameter. Three identical stainless steel right angled retractors with blades 4.4 cm / 1 3/4" wide by 10.2 cm / 4" deep, have 20.3 cm / 8" handles, and may be placed anywhere around the ring. The angle and counter traction of the blades serve to hold the retractor securely in place.



32-3416-00
45 x 17 mm
Fig. 1



32-3417-00
90 x 37 mm
Fig. 2



32-3418-00
90 x 45 mm
Fig. 3



Friedman
32-3420-10
10 cm / 4"
32-3420-13
13 cm / 5"



Rigby
15-3675-18
18 cm / 7"



Gelpi
15-3665-09 9 cm / 3½"
15-3665-11 11.5 cm / 4½"
15-3665-14 14 cm / 5½"
15-3665-16 16 cm / 6¼"
15-3665-18 18 cm / 7"



Gelpi
15-3670-18
18 cm / 7"

Uterine Dilators
Uterus Dilatatores
Dilatadores uterinos



32-3440-00

Set of 14 pieces
4 mm to 17 mm

32-3441-00

Set of 26 pieces
1 mm to 26 mm



32-3445-00	1 mm
32-3446-00	2 mm
32-3447-00	3 mm
32-3448-00	4 mm
32-3449-00	5 mm
32-3450-00	6 mm
32-3451-00	7 mm
32-3452-00	8 mm
32-3453-00	9 mm
32-3454-00	10 mm
32-3455-00	11 mm
32-3456-00	12 mm
32-3457-00	13 mm
32-3458-00	14 mm
32-3459-00	15 mm
32-3460-00	16 mm
32-3461-00	17 mm
32-3462-00	18 mm
32-3463-00	19 mm
32-3464-00	20 mm
32-3465-00	21 mm
32-3466-00	22 mm
32-3467-00	23 mm
32-3468-00	24 mm
32-3469-00	25 mm
32-3470-00	26 mm

Hegar

Uterine dilators, single ended
with sloped handle

32-3444-00

Set of 26 pieces



Hawkins-Amber

Set of 16; 3 to 18

32-3476-00

Set of 16, 6 to 21

Uterine Dilators
Uterus Dilatatores
Dilatadores uterinos



32-3481-00	1/2 mm
32-3482-00	3/4 mm
32-3483-00	5/6 mm
32-3484-00	7/8 mm
32-3485-00	9/10 mm
32-3486-00	11/12 mm
32-3487-00	13/14 mm
32-3488-00	15/16 mm
32-3489-00	17/18 mm
32-3490-00	19/20 mm
32-3491-00	21/22 mm
32-3492-00	23/24 mm
32-3493-00	25/26 mm

32-3480-00
Set of 13 dilators



32-3496-26	13/15
32-3497-26	17/19
32-3498-26	21/23
32-3499-26	25/27
32-3501-26	29/31
32-3502-26	33/35
32-3503-26	37/39
32-3504-26	41/43

Pratt
32-3495-26
26.5 cm / 10½"
Double ended
Set of 8 dilators



Hegar
Double ended
32-3505-20
Set of 8 dilators including
32-3482-00 32-3486-00
32-3483-00 32-3487-00
32-3484-00 32-3488-00
32-3485-00 32-3489-00
20 cm / 7½"
Available in canvas and synthetic pouch

Dilating Bougies, Metal Catheters
 Dilatationsbougie, Metallkatheter
 Bujías dilatadores, Sondas metálicas

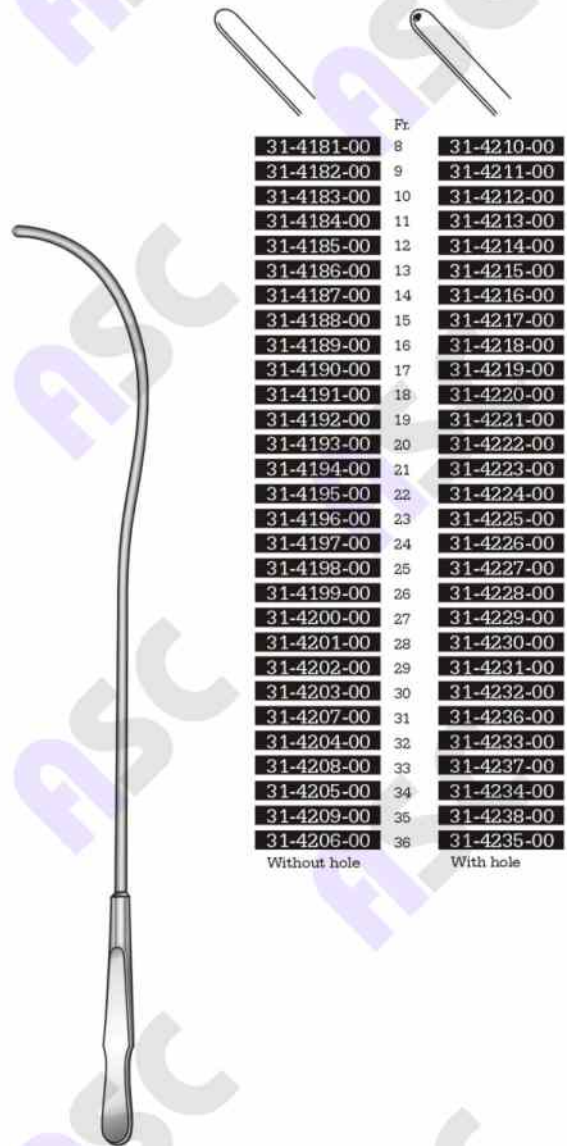

Guyon
31-4180-00
 Set

	Fr.	
	8	31-4210-00
	9	31-4211-00
	10	31-4212-00
	11	31-4213-00
	12	31-4214-00
	13	31-4215-00
	14	31-4216-00
	15	31-4217-00
	16	31-4218-00
	17	31-4219-00
	18	31-4220-00
	19	31-4221-00
	20	31-4222-00
	21	31-4223-00
	22	31-4224-00
	23	31-4225-00
	24	31-4226-00
	25	31-4227-00
	26	31-4228-00
	27	31-4229-00
	28	31-4230-00
	29	31-4231-00
	30	31-4232-00
	31	31-4233-00
	32	31-4234-00
	33	31-4235-00
	34	31-4236-00
	35	31-4237-00
	36	31-4238-00

Without hole With hole



Guyon
31-3510-36
 36.5 cm / 14 1/2"

Uterine Dilators
Uterus Dilatatores
Dilatadores uterinos



Hegar
32-3515-00
 Set of 13
 Fig. 1-13
 Stainless Steel
32-3516-00
 Set of 13
 Fig. 1-13
 Chrome plated



Hank Set
32-3518-00 Canvas pouch
32-3519-00 Synthetic pouch
 Set of 6



32-3520-00
 4.5/5 mm \emptyset
 Fig. 9/10



32-3525-00
 5.5/6 mm \emptyset
 Fig. 11/12



32-3530-00
 6.5/7 mm \emptyset
 Fig. 13/14



32-3535-00
 7.5/8 mm \emptyset
 Fig. 15/16



32-3540-00
 8.5/9 mm \emptyset
 Fig. 17/18



32-3545-00
 9.5/10 mm \emptyset
 Fig. 19/20

Tenaculum Forceps
Hakenzangen
Pinzas para coger el cuello del útero



Goodell
32-3550-34
34 cm / 13½"

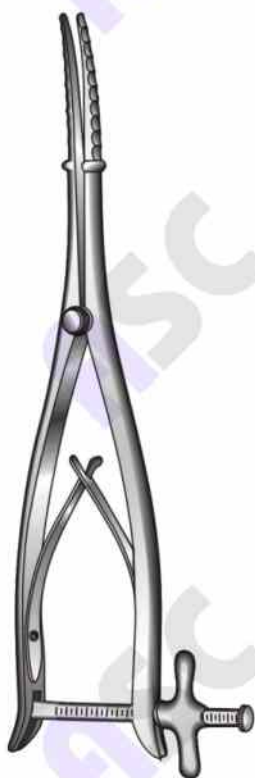

Wylie
32-3555-29
29 cm / 11½"



Sims
32-3560-29
29 cm / 11½"

Tenaculum Forceps
Hakenzangen
Pinzas para coger el cuello del útero



Staude-Moore
32-3565-17
17 cm / 6 3/4"
Strong pattern



Hulka
32-3570-28
28 cm / 11"



Pozzi
32-3575-25
25.5 cm / 10 1/4"



Schroeder
32-3580-25
25 cm / 10"



Braun
32-3585-25
25 cm / 10"

Tenaculum Forceps
Hakenzangen
Pinzas para coger el cuello del útero



Pozzi Palmer
32-3590-23
23.5 cm / 9¼"



Pozzi Palmer
32-3595-23
23.5 cm / 9¼"



Barrett
32-3601-18
18 cm / 7"

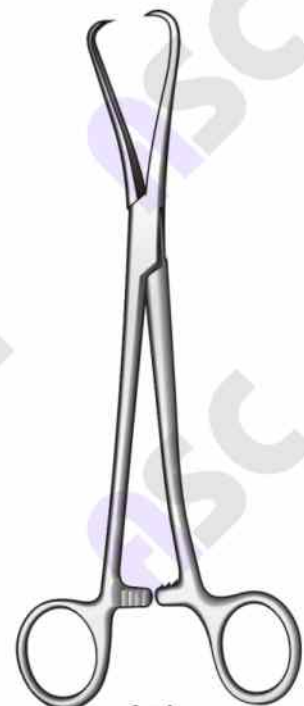

Jarcho
32-3605-20
20 cm / 8"

Tenaculum Forceps, Amniotome
Hakenzangen, Amniotom
Pinzas para coger el cuello del útero, Amniotomo



Duplay
32-3610-20
20 cm / 11"



Beacham
32-3615-26
26 cm / 10 1/4"
Amniotome for amnion bladder



Skene
32-3620-24
24 cm / 9 1/2"
Curved sideways

Tenaculum Forceps
Hakenzangen
Pinzas para coger el cuello del útero

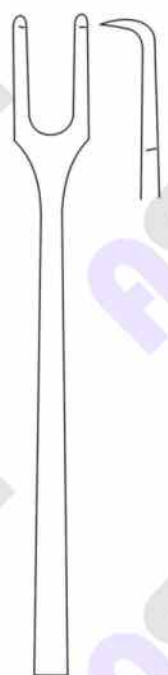

32-3625-24
Curved
Side ways

32-3626-24
Straight



Schroeder
24 cm / 9 1/2"

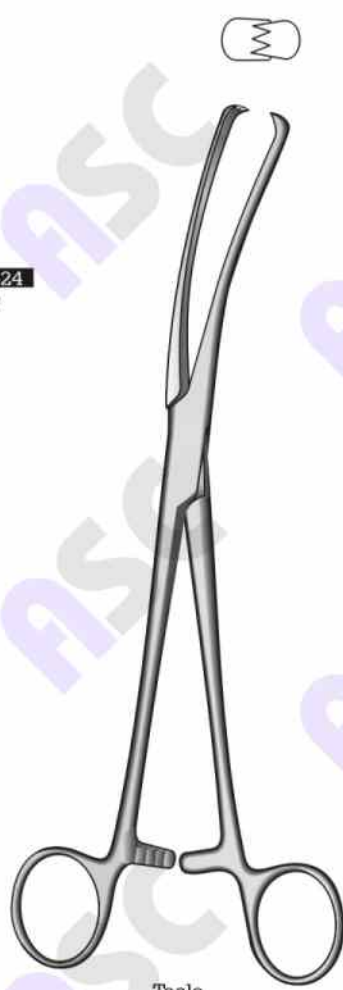

Teale
32-3630-23
23 cm / 9"

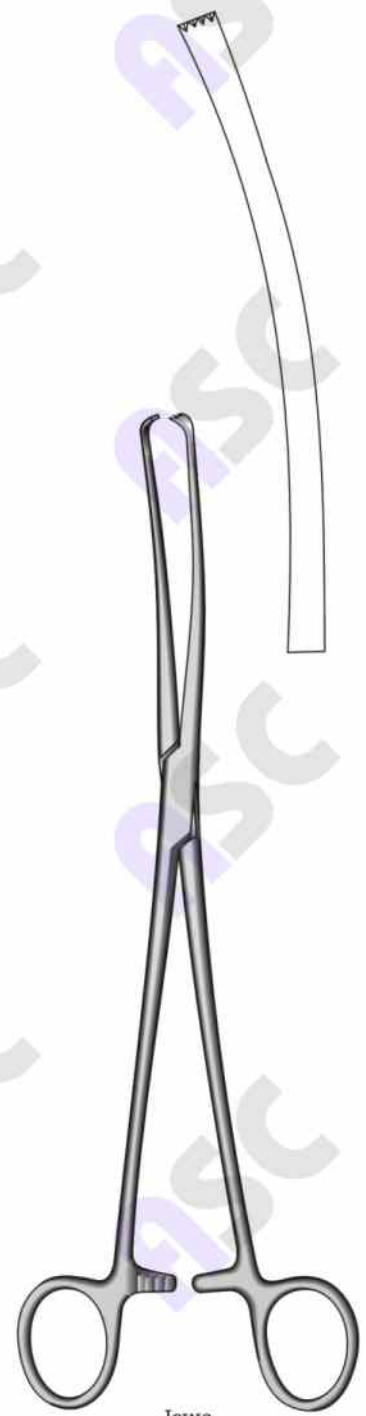

Iowa
32-3635-26
26 cm / 10 1/4"
For the amnion bladder

Tenaculum Forceps
Hakenzangen
Pinzas para coger el cuello del útero



32-3646-24
6 mm



32-3647-24
8 mm



32-3648-24
10 mm



32-3649-24
6 mm



32-3650-24
8 mm



32-3651-24
10 mm



Museux
24 cm / 9½"
Straight



Museux
24 cm / 9½"
Curved



Jacobs
32-3640-21
21 cm / 8½"

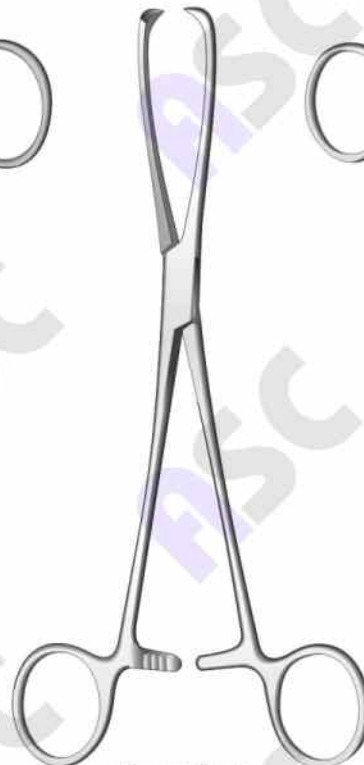

Museux Droite
32-3655-18 18 cm / 7"
32-3655-20 20 cm / 8"
32-3655-25 25 cm / 10"

Tenaculum Forceps
Hakenzangen
Pinzas para coger el cuello del útero



Uterine Polypus Forceps
Uterus Polypenzangen
Pinzas para pólipos uterinos



Noto
32-3680-27
27 cm / 10 1/2"

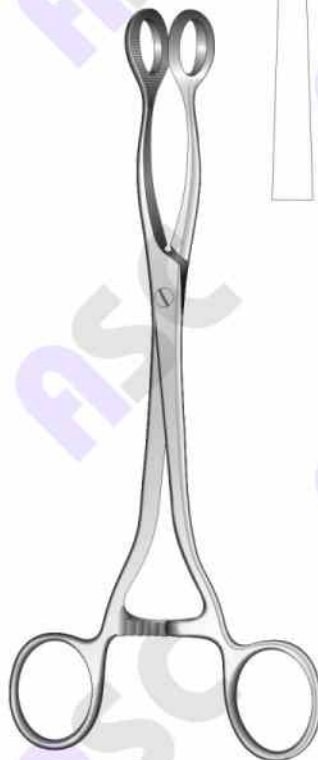

Doyen
32-3685-20
20 cm / 8"



Kelly
32-3690-32
32 cm / 12 1/2"

Sponge Forceps
Schwammzangen
Pinzas para tapones



Foerster

14-3055-25
25 cm / 10"
Smooth jaws

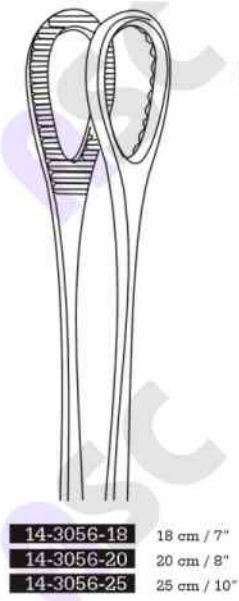

14-3056-18 18 cm / 7"
14-3056-20 20 cm / 8"
14-3056-25 25 cm / 10"

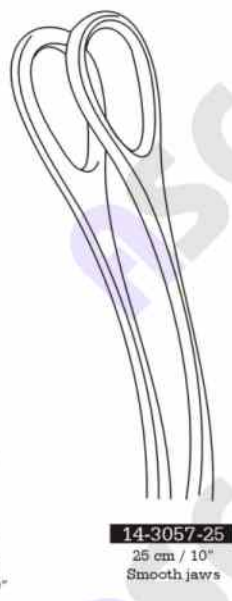

14-3057-25
25 cm / 10"
Smooth jaws



14-3058-18 18 cm / 7"
14-3058-20 20 cm / 8"
14-3058-24 25 cm / 10"



Rampley
14-3060-18 18 cm / 7"
14-3060-25 25 cm / 10"

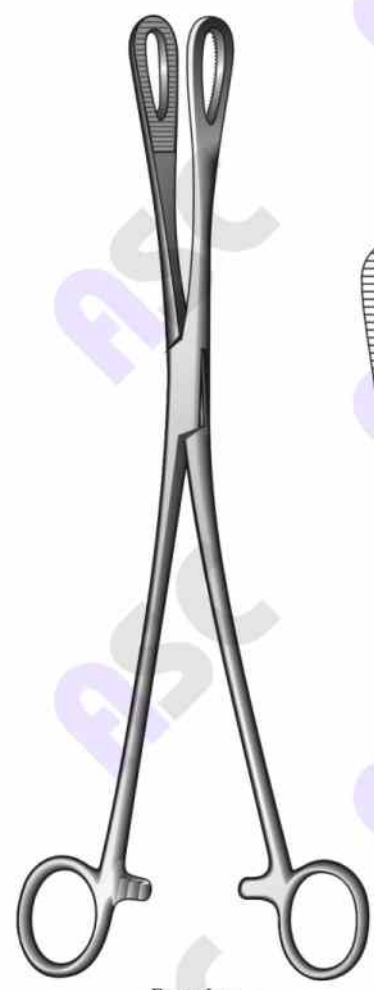

Rampley

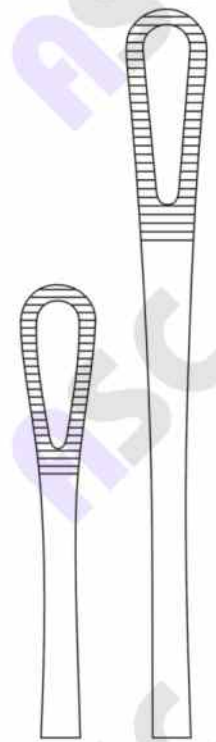

14-3065-18 18 cm / 7"
14-3065-24 25 cm / 10"
Box lock
14-3066-18 18 cm / 7"
14-3066-24 25 cm / 10"
Screw lock

Hysterectomy, Vaginal Clamp Forceps
Hysterektomieklennen, Vaginalklennen
Pinzas clamps para histerectomia y vaginales



Heaney

- 13-3585-19** 19 cm / 7½"
- 13-3585-21** 21 cm / 8¼"
- 13-3585-24** 24.5 cm / 9¾"

Hysterectomy forceps
Heavy pattern, single tooth
Curved



Heaney

- 13-3590-19** 19 cm / 7½"
- 13-3590-21** 21 cm / 8¼"
- Heavy pattern
- 13-3590-24** 24.5 cm / 9¾"

Extra heavy pattern
Hysterectomy forceps
double tooth, curved



Heaney-Ballentine

21 cm / 8¼"
Longitudinal serrations, single tooth



13-3595-21
Straight

13-3596-21
Curved



Ballentine

13-3600-21

Garland

13-3601-21

21 cm / 8¼"
Longitudinal serrations,
single tooth, angled on flat

Dressing Forceps, Sponge Forceps
Kornzangen, Schwammzangen
Pinzas para vendajes, Pinzas para tapones



Cheron
14-3035-25
25 cm / 10"

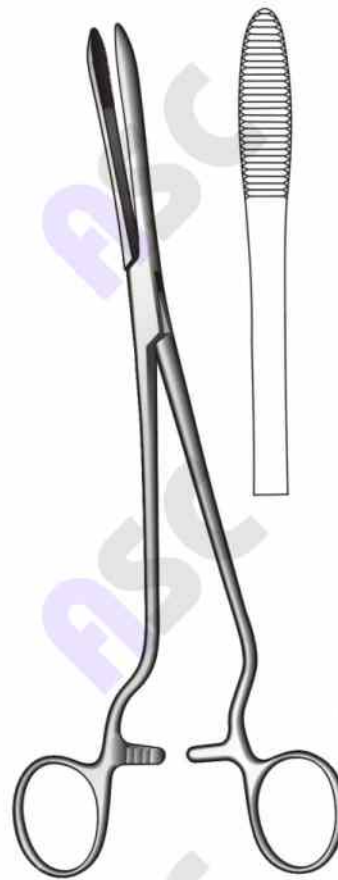

Cheron
14-3045-24
24 cm / 9½"
Handles laterally angled



14-3040-26
Straight

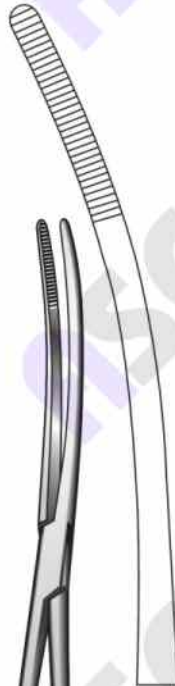

14-3041-26
Curved

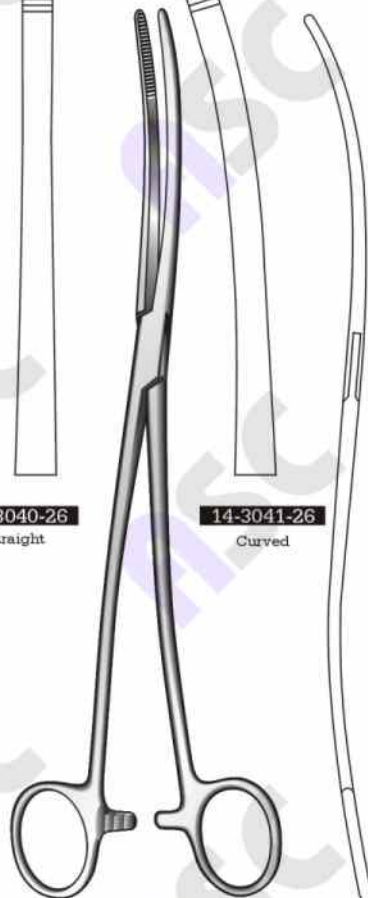

Bozemann
26 cm / 10¼"

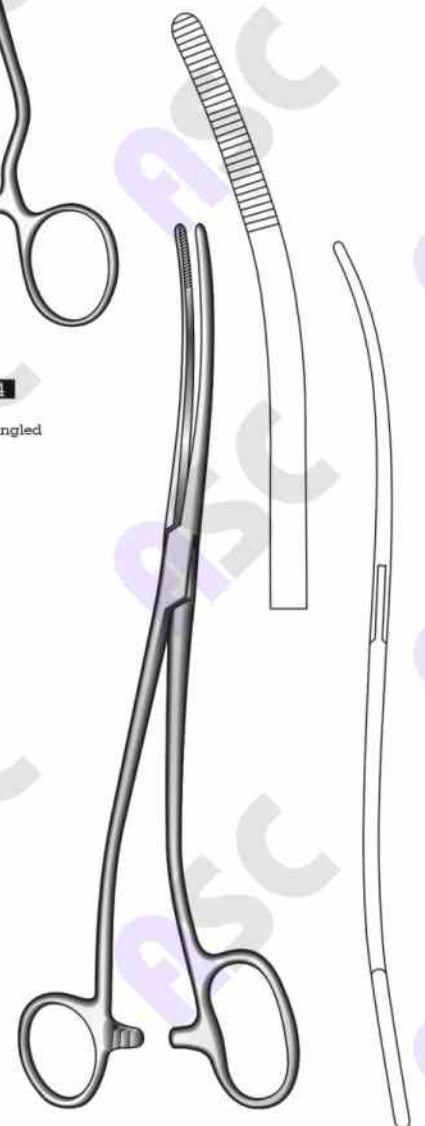

Bozemann-Douglas
14-3050-26
26 cm / 10¼"
One ring large

Uterine Elevating Forceps
Uterusfasszangen
Pinzas para el útero



Dartigues
32-3695-27
27 cm / 10½"



Somer
32-3701-23
23 cm / 9"

Uterine Elevating Forceps
Uterusfasszangen
Pinzas para el útero

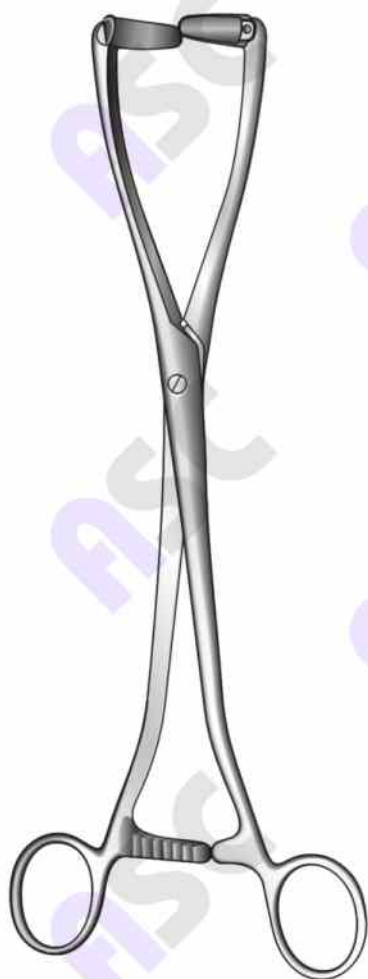
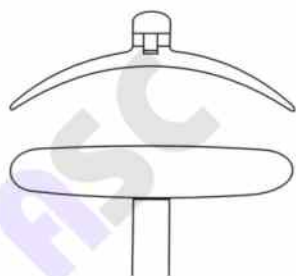

Collin
32-3705-25
25 cm / 10"



Shirodka Magendie
32-3710-26
26 cm / 10 1/4"

Uterine Sounds, Depressors
Uterussonden, Depressoren
Histerometoros, Depressorer uterinos



Sims
32-3715-32
32 cm / 12½"
Malleable



32-3720-32
32 cm / 12½"
Malleable



32-3725-00
Uterine probe



Valleix
32-3730-25
25 cm / 10"

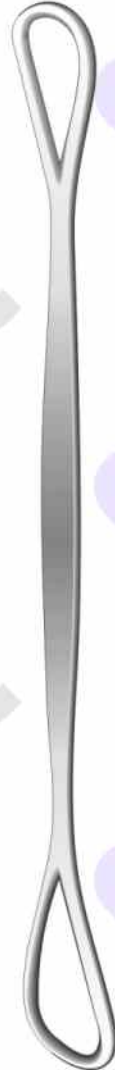

Braun
32-3735-27
27.5 cm / 11"



Sims
32-3740-26
26 cm / 10½"

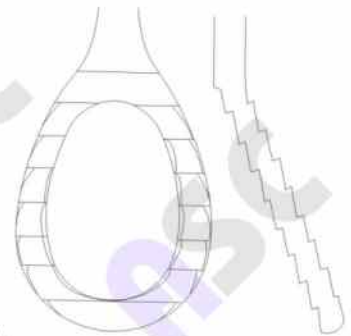
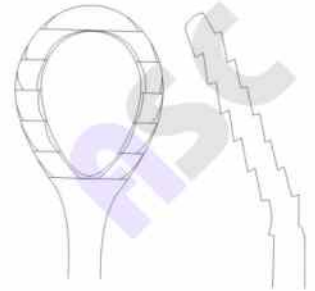

Myoma Instruments
Myom Instrumente
Instrumentos para fibromas

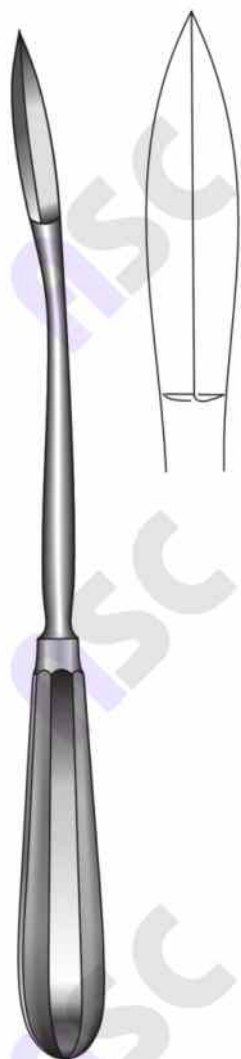

Segond
32-3745-00
28 cm / 11"
Cutting edge 13 mm wide



Doyen
32-3750-14
14 cm / 5½"
Spiral



Doyen
32-3755-17
17 cm / 6¼"
Spiral



Ayre
32-3760-23
23 cm / 9"
Conization knife
Cutting edge 6.3 mm wide



Simon
32-3765-22
22 cm / 8 1/4"



Simon
32-3770-22
22 cm / 8 1/4"



Emmet
Uterine tenaculum hooks
23 cm / 9"
Sharp points



32-3775-23
Half-curved, small
Fig. 1



32-3776-23
Actual angle
Fig. 2



32-3777-23
Right angle
Fig. 3



32-3778-23
Half-curved, large
Fig. 4



32-3779-23
Double angle
Fig. 5

Suction Curettes, Uterine Biopsy Curettes
Saugkürretten, Biopsiekürretten
Curetas aspiradoras, Curetas para la biopsia



32-3785-30
Without basket

32-3786-30
With basket

Kevorkian
30 cm / 12"



Novak
32-3790-23 4 mm
32-3791-23 3 mm
23 cm / 12"
With luer lock connection



Mod. Muenchen
32-3795-27
27 cm / 10 1/2"
4.8 mm Ø



Randell
32-3801-24 4 mm
32-3802-24 3 mm
24 cm / 9 1/2"

Aspirating Curettes
Absaugküretten
Curetas de aspiracion

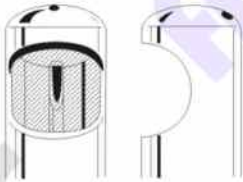
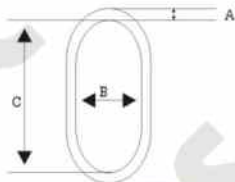

	A	B	C
32-3810-00	5 mm	1 mm	4.0 mm
32-3811-00	6 mm	1 mm	5.0 mm
32-3812-00	7 mm	1 mm	5.5 mm
32-3813-00	8 mm	1 mm	6.0 mm
32-3814-00	9 mm	1 mm	6.5 mm
32-3815-00	10 mm	2 mm	7.5 mm
32-3816-00	12 mm	2 mm	10 mm
32-3817-00	14 mm	2 mm	11 mm

Uterine suction tube



32-3830-00
6 mm

32-3831-00
8 mm



32-3832-00
10 mm

32-3833-00
12 mm



32-3834-00
14 mm



32-3805-13

13 cm / 5"

Uterine suction connector

Uterine suction tubes



32-3820-00

29 cm / 11½"

3 mm
Specimen &
aspirating
curette

32-3825-00

29 cm / 11½"

4.5 mm
Specimen &
aspirating
curette



Aspirating curettes

29 cm / 11½"



32-3840-00

12 cm / 4¾"

Coupling piece

Uterine Curettes
 Uterusküretten
 Curetas uterinas



Rigid curettes
 [Plain shaft]



Malleable curettes
 [Grooved shaft]



Recamier-Sims-Bumm
 Sharp blades



Recamier-Sims-Bumm
 Blunt blades

Sharp blades

Rigid		Malleable		Fig.	Size mm
26 cm	31 cm	26 cm	31 cm		
32-3845-26	32-3865-31	32-3885-26	32-3905-31	00	5
32-3846-26	32-3866-31	32-3886-26	32-3906-31	0	6
32-3847-26	32-3867-31	32-3887-26	32-3907-31	1	7
32-3848-26	32-3868-31	32-3888-26	32-3908-31	2	8
32-3849-26	32-3869-31	32-3889-26	32-3909-31	3	9
32-3850-26	32-3870-31	32-3890-26	32-3910-31	4	11
32-3851-26	32-3871-31	32-3891-26	32-3911-31	5	12
32-3852-26	32-3872-31	32-3892-26	32-3912-31	6	14
32-3853-26	32-3873-31	32-3893-26	32-3913-31	7	15
32-3854-26	32-3874-31	32-3894-26	32-3914-31	8	16
32-3855-26	32-3875-31	32-3895-26	32-3915-31	9	19
32-3856-26	32-3876-31	32-3896-26	32-3916-31	10	20
32-3857-26	32-3877-31	32-3897-26	32-3917-31	11	21
32-3858-26	32-3878-31	32-3898-26	32-3918-31	12	23
	34 cm		34 cm		
	32-3879-34		32-3919-34	13	25
	32-3880-34		32-3920-34	14	30
	32-3881-34		32-3921-34	15	35
	32-3882-34		32-3922-34	16	40

Blunt blades

Rigid		Malleable		Fig.	Size mm
26 cm	31 cm	26 cm	31 cm		
32-3925-26	32-3945-31	32-3965-26	32-3985-31	00	5
32-3926-26	32-3946-31	32-3966-26	32-3986-31	0	6
32-3927-26	32-3947-31	32-3967-26	32-3987-31	1	7
32-3928-26	32-3948-31	32-3968-26	32-3988-31	2	8
32-3929-26	32-3949-31	32-3969-26	32-3989-31	3	9
32-3930-26	32-3950-31	32-3970-26	32-3990-31	4	11
32-3931-26	32-3951-31	32-3971-26	32-3991-31	5	12
32-3932-26	32-3952-31	32-3972-26	32-3992-31	6	14
32-3933-26	32-3953-31	32-3973-26	32-3993-31	7	15
32-3934-26	32-3954-31	32-3974-26	32-3994-31	8	16
32-3935-26	32-3955-31	32-3975-26	32-3995-31	9	19
32-3936-26	32-3956-31	32-3976-26	32-3996-31	10	20
32-3937-26	32-3957-31	32-3977-26	32-3997-31	11	21
32-3938-26	32-3958-31	32-3978-26	32-3998-31	12	23
	34 cm		34 cm		
	32-3959-34		32-3999-34	13	25
	32-3960-34		32-4000-34	14	30
	32-3961-34		32-4001-34	15	35
	32-3962-34		32-4002-34	16	40



Uterine Curettes
Uterusküretten
Curetas uterinas





Schroeder
30 cm / 12"
Sharp, rigid

Simon
25 cm / 10"
Sharp, rigid

Uterine Biopsy Forceps
Probeexzisionszangen
Pinzas sacaboacados para el cuello del útero



Gellhorn
32-4050-23
23 cm / 9"



Faure
32-4055-21
21 cm / 8¼"



Schubert
32-4060-21 21 cm / 8¼"
32-4060-29 29 cm / 11½"

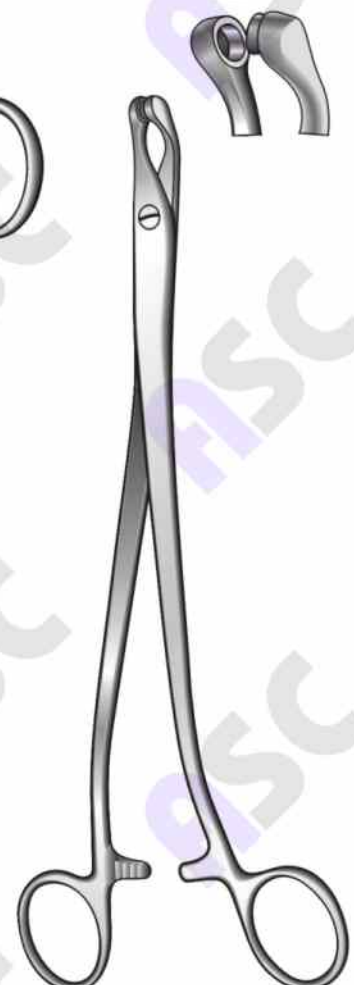

Thoms-Gaylor
32-4065-24
24 cm / 9½"

Uterine Biopsy Forceps
Probeexzisionszangen
Pinzas sacaboacados para el cuello del útero



Thoms-Gaylor
32-4070-22 22 cm / 8½"
32-4070-24 24 cm / 9½"

Schubert
32-4075-26
26 cm / 10¼"

Van-Doren
32-4080-24
24 cm / 9½"

Uterine Biopsy Forceps
Probeexzisionszangen
Pinzas sacaboacados para el cuello del útero



Van-Doren
32-4085-25
25 cm / 10"



4 x 8 mm

Wittner
32-4090-23
Straight
32-4091-23
Curved
23 cm / 9"

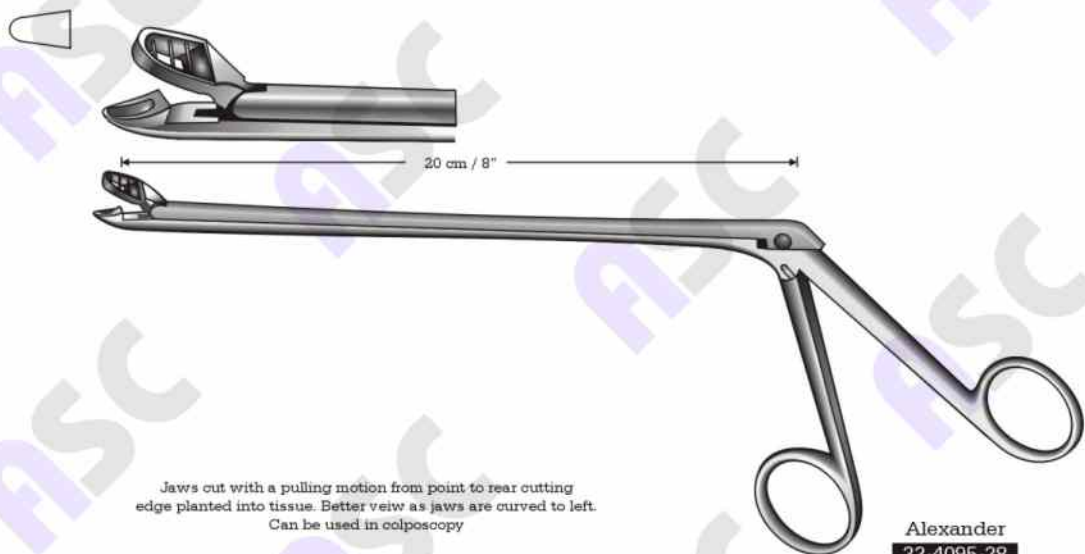

Jaws cut with a pulling motion from point to rear cutting edge planted into tissue. Better view as jaws are curved to left. Can be used in colposcopy

Alexander
32-4095-28
28 cm / 11"

Cervical Biopsy and Specimen Forceps
Probeexzisionszangen
Pinzas sacaboacados para el cuello del útero

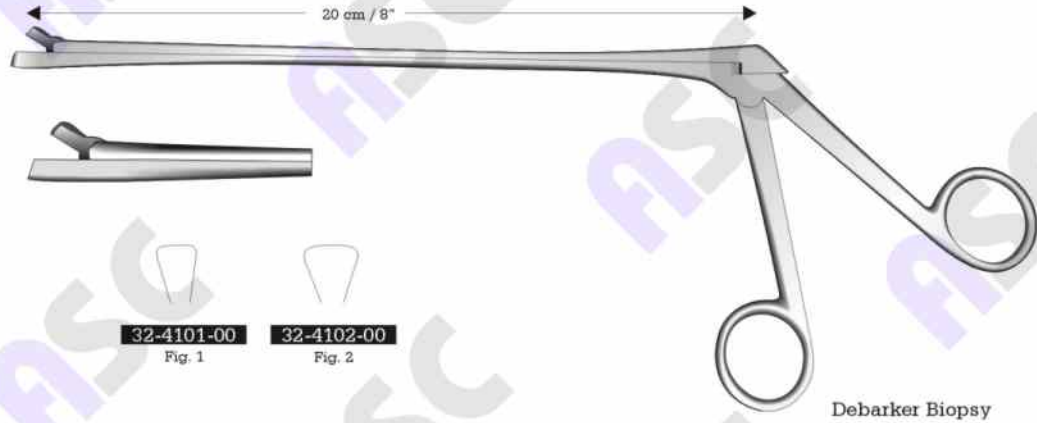

Uterine Biopsy Forceps
Probeexzisionszangen
Pinzas sacaboacados para el cuello del útero

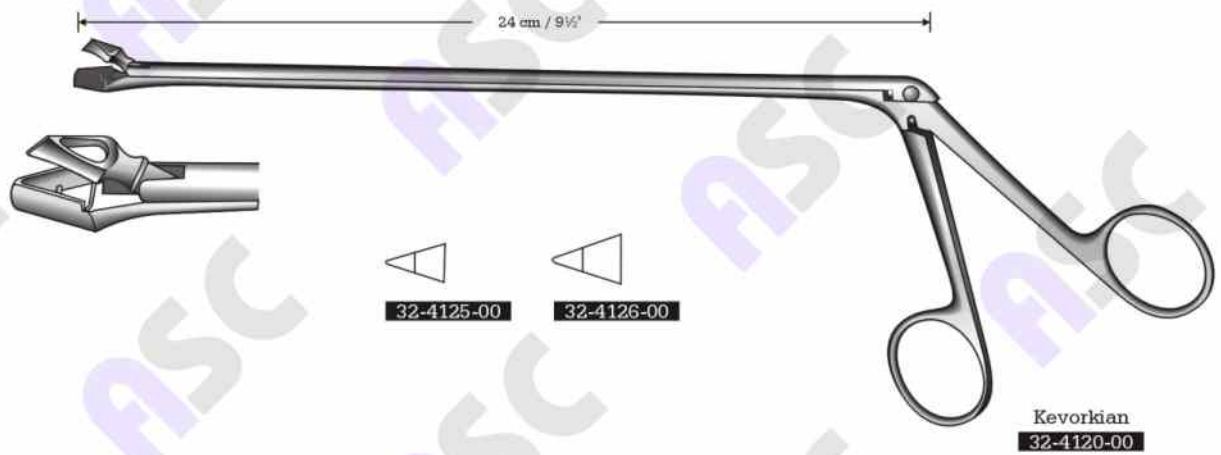

Cervical Biopsy and Specimen Forceps
Probeexzisionszangen
Pinzas sacaboacados para el cuello del útero

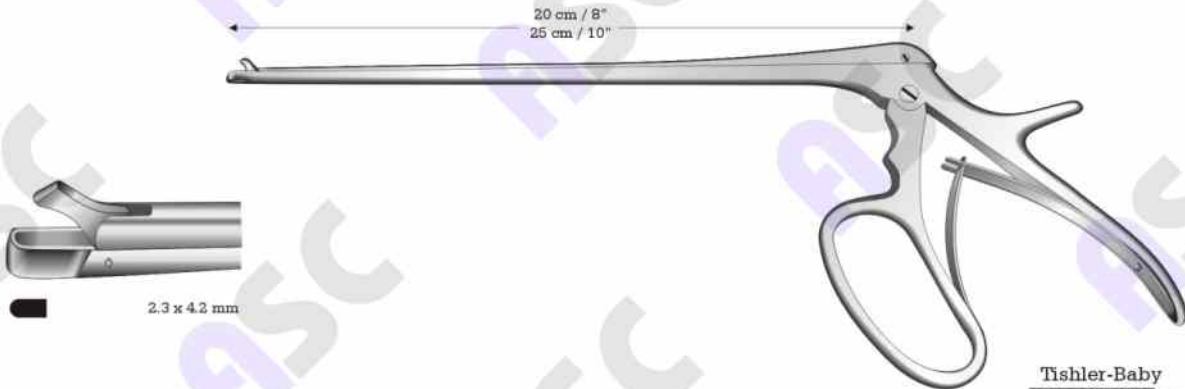

Tishler-Baby
32-4135-20 20 cm / 8"
32-4135-25 25 cm / 10"
With lock

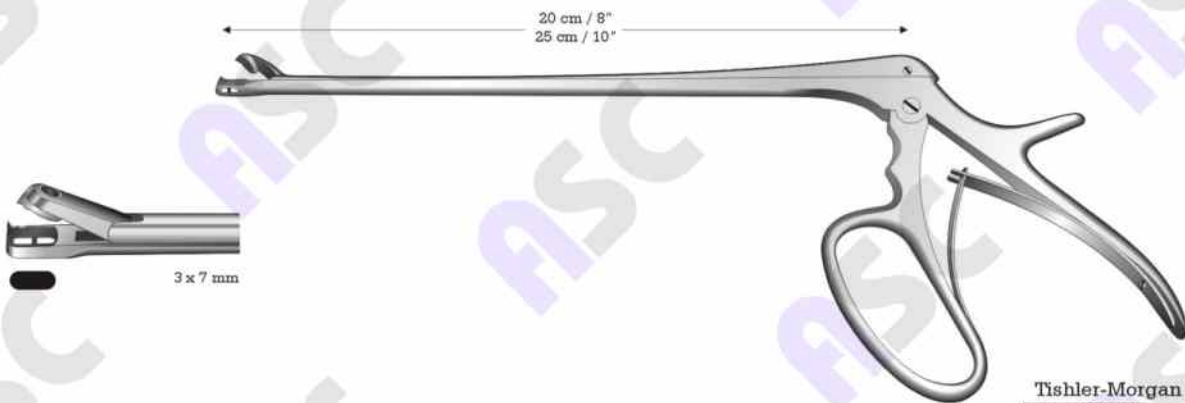

Tishler-Morgan
32-4140-20 20 cm / 8"
32-4140-25 25 cm / 10"
With lock

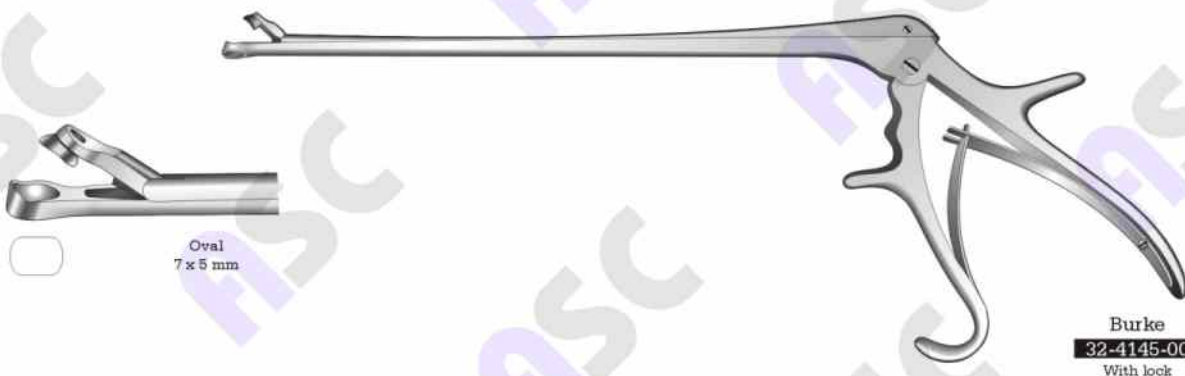

Burke
32-4145-00
With lock

Uterine Biopsy Forceps
 Probeexzisionszangen
 Pinzas sacaboacados para el cuello del útero



Seiffert
 32-4155-00



Schumacher
 32-4160-00
 With drawing cut



Tischler
 32-4165-00



Kevorkian
 32-4170-00



Krause
 32-4175-00 32-4176-00



32-4180-00



32-4185-00



Huber
 32-4190-00
 Universal handle

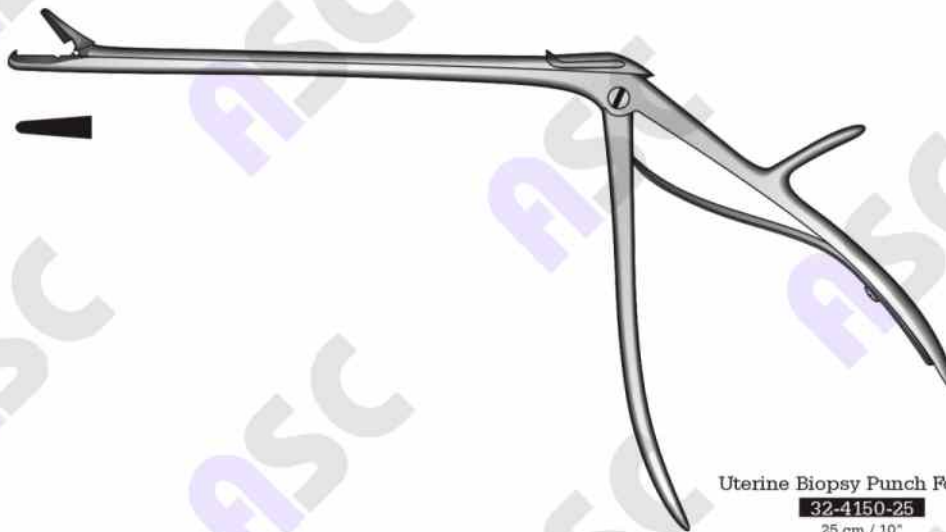

Uterine Biopsy Punch Forceps
 32-4150-25
 25 cm / 10"



Tischler-Morgan
 32-4201-00 Complete with handle
 32-4202-00 Tip only
 Fig. 1



Townsend
 32-4195-00
 Handle only



32-4205-00 Complete with handle
 32-4206-00 Tip only
 Fig. 3



32-4210-00 Complete with handle
 32-4211-00 Tip only
 mini
 Fig. 5



Kevorkian
 32-4215-00 Complete with handle
 32-4216-00 Tip only
 Fig. 4



Collyer
32-4220-30
30 cm / 12"



32-4225-34
34 cm / 13 1/2"
Graduated in centimeters.



Delee
32-4230-00
For interior measurements
between symphysis and
promontory

Pelvimeters
Beckenzirkel
Pelvimetros



Breisky
32-4235-33
33 cm / 13"
Graduated in centimeters.

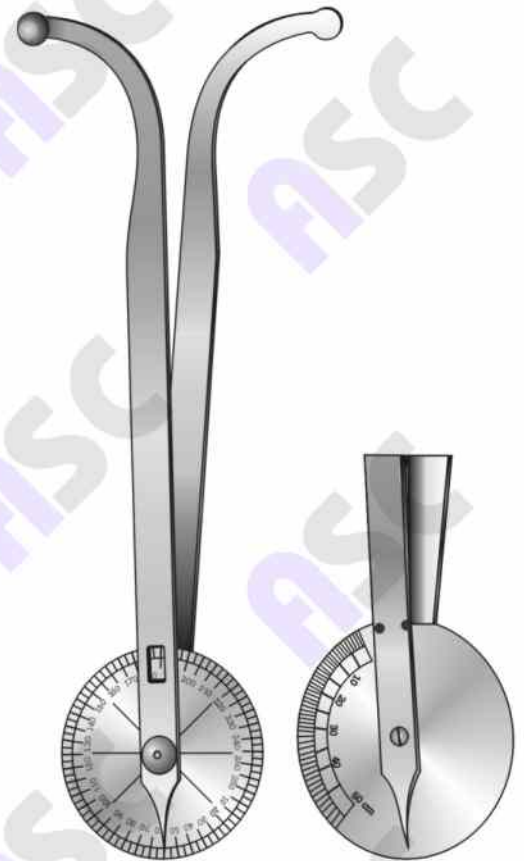

Thole
17-3085-34
34 cm / 13½"
Goniometer, graduated in centimeters.
For internal & external measurements.



Collin
32-4245-35
35 cm / 13¾"
Graduated in centimeters.

Obstetrical (Midwifery) Forceps
Geburtszangen
Fórceps obstétricos



Kielland
32-4250-42
42 cm / 16 1/2"



Nagele
32-4255-40
40 cm / 16"

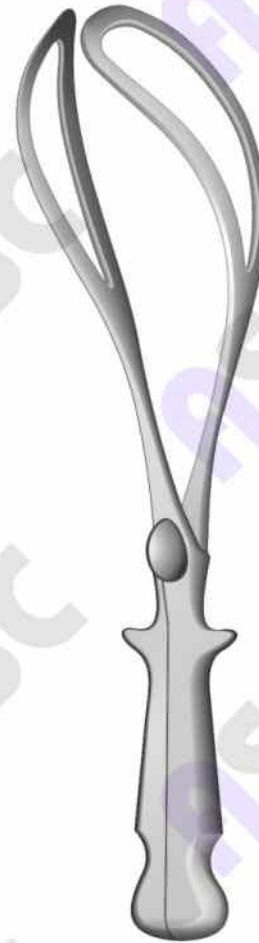

Nagele
32-4260-35
35.5 cm / 14 1/8"

Obstetrical (Midwifery) Forceps
Geburtszangen
Fórceps obstétricos



Simpson-Braun

32-4265-30

30.5 cm / 12"

32-4265-35

35 cm / 14"



Simpson-Braun

32-4270-35

35 cm / 14"

32-4270-30

30.5 cm / 12"



Piper

32-4275-44

44.5 cm / 17½"

For delivery of the after
coming head in breech
presentation



Boerma

32-4280-28

28 cm / 11"

For caesarean section



Simpson

32-4285-23

23.5 cm / 9¼"

For caesarean section



Wrigley
32-4290-25
25 cm / 10"
For caesarean section



Mclean
32-4295-39
39.5 cm / 15½"
Solid blades, short shanks

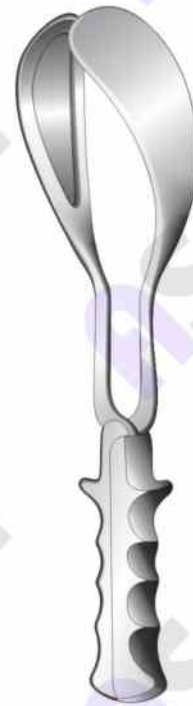

Simpsons-Luikart
32-4301-38
38 cm / 15"
Solid blades



Luikart
32-4305-39
39.5 cm / 15½"
Solid blades



Kielland-Luikart
32-4310-39
39.5 cm / 15½"
Solid blades



Kielland
32-4315-39
39.5 cm / 15½"

Obstetrical (Midwifery) Forceps
Geburtszangen
Fórceps obstétricos



Dewey
32-4325-35
35.5 cm / 14"
Obstetrical forceps
with axis traction



Murless
32-4320-25
25.5 cm / 10"
Head extractor
with hinged shaft and sliding collar lock



Bailey-Williamson
32-4330-39
39.5 cm / 15½"



Hawks-Dennen
32-4335-38
38 cm / 15"



Barton
32-4340-35
35.5 cm / 14"
One hinged blade



McLean-Luikart
32-4345-40
40 cm / 15¾"
Solid blades, long shanks



McLean-Tucker-Luikart
32-4350-40
40 cm / 15¾"
Solid blades, long shanks

Obstetrical (Midwifery) Forceps
Geburtszangen
Fórceps obstétricos



Tarnier
32-4355-40
40 cm / 16"
With traction rod



Barnes-Neville
32-4360-43
43.5 cm / 17"
With traction handle

Obstetrical (Midwifery) Forceps
Geburtszangen
Fórceps obstétricos



Barton
32-4365-36
36 cm / 14 1/2"

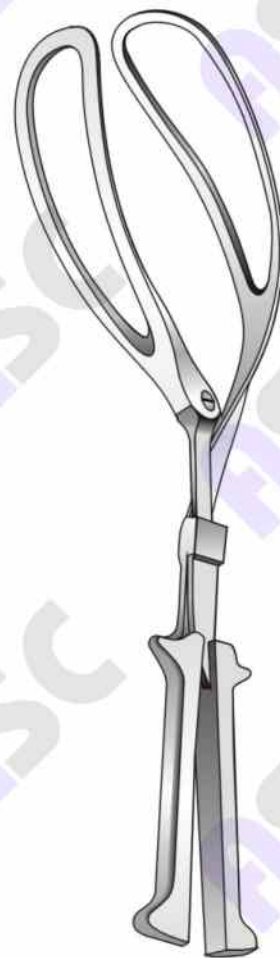

Demelin Suzor
32-4370-32
32 cm / 12 1/2"

Obstetrics Perforator, Cranioclast, Basiotribe
Geburtshilfe Perforatorium, Kranioklast, Basiotrib
Obstetricia perfora-cráneo, Craneóclasto



Tarnier
32-4375-44
44 cm / 17½"
Basiotribe

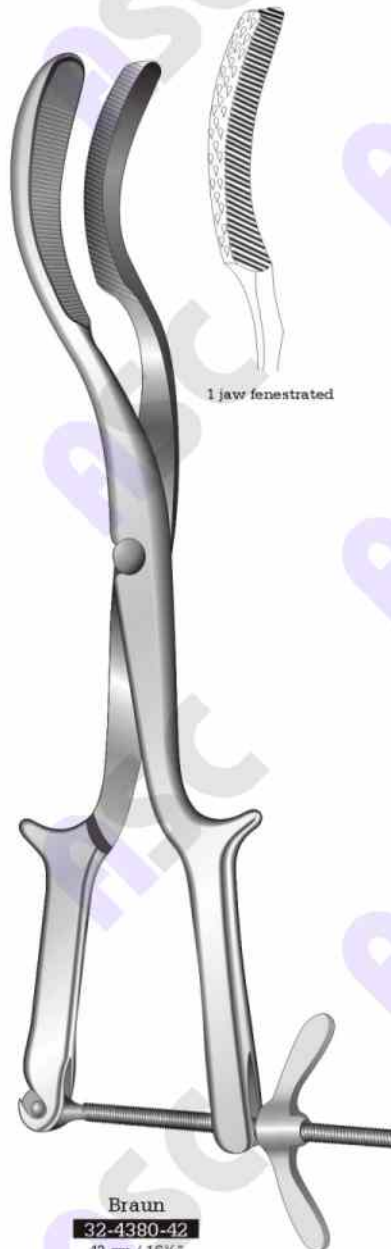

1 jaw fenestrated

Braun
32-4380-42
42 cm / 16¾"
Cranioclast



Naegele
32-4385-25
25 cm / 10"

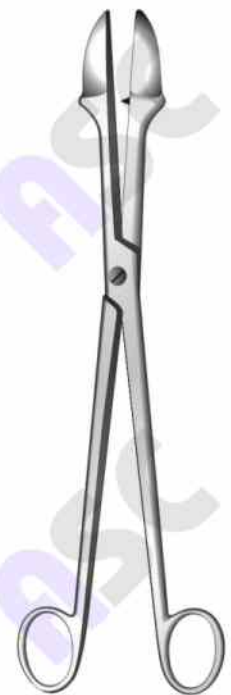

Smellie
32-4390-27
27 cm / 10¾"
Perforator

Ovum Forceps
Abortuszangen
Pinzas para aborto

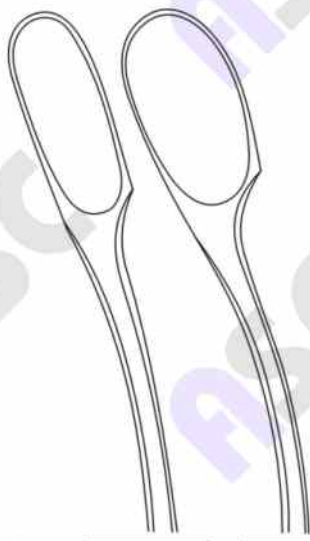

32-4395-29

32-4396-29

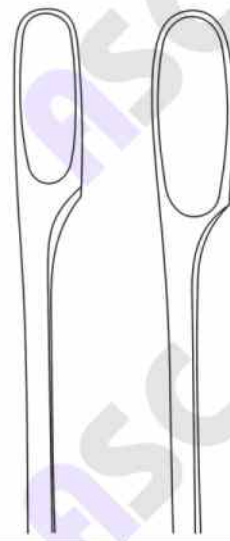

32-4401-29

32-4402-29

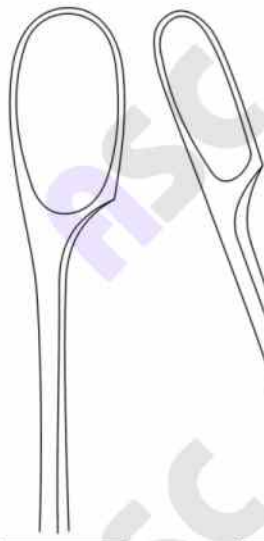

32-4403-29

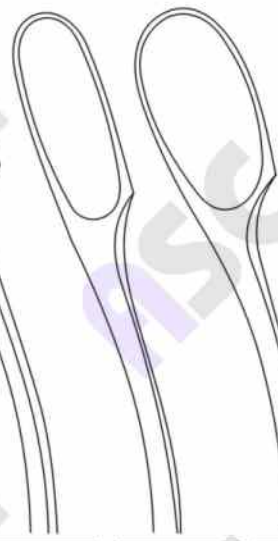

32-4405-29

32-4406-29

32-4407-29



Ovum Forceps
Abortuszangen
Pinzas para aborto

Winter
29 cm / 11½"
With ratchet



Winter
29 cm / 11½"



Winter
29 cm / 11½"



32-4410-28
28.5 cm / 11½"
With protecting cap

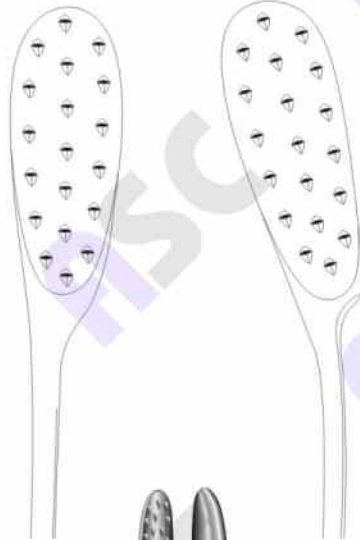

32-4412-24
Straight

32-4415-24
Curved

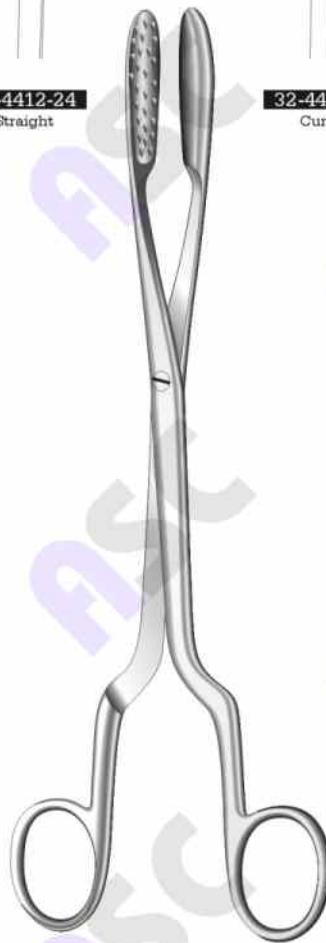

Lewkowitz
24.5 cm / 9½"



Mc Clintock
32-4420-24
24 cm / 9½"

Ovum Forceps
Abortuszangen
Pinzas para aborto



Saenger
32-4425-26
26.5 cm / 10½"

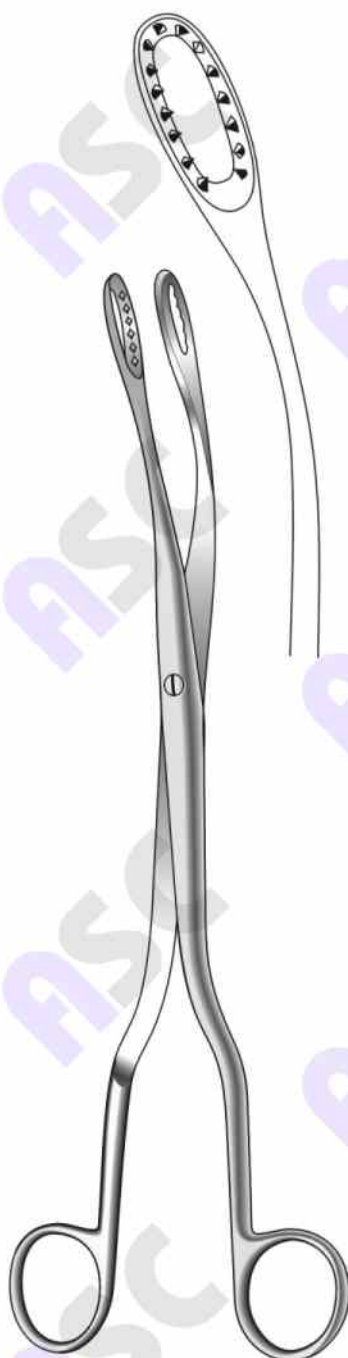

Saenger
32-4430-28
28.5 cm / 11¼"

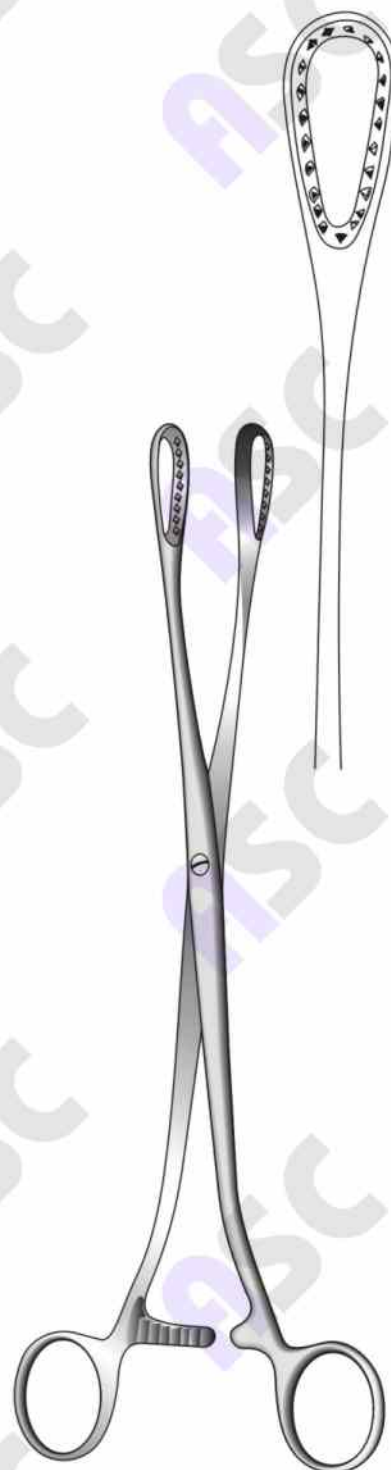

Saenger
32-4435-27
27.5 cm / 10¾"



32-4440-25
Fig. 1



32-4441-25
Fig. 2



32-4442-25
Fig. 3



32-4443-25
Fig. 4



32-4444-25
Fig. 5



Placenta Forceps
25 cm / 10"



32-4450-27
Small
Fig. 1



32-4451-27
Medium
Fig. 2



32-4452-27
Large
Fig. 3



Hirst
27.5 cm / 10 7/8"
Placenta Forceps

Obstetrical Forceps, Hook & Scissors
Geburtszangen, haken und-scheren
Forceps Obstetricos, Gancho Y Tijeras

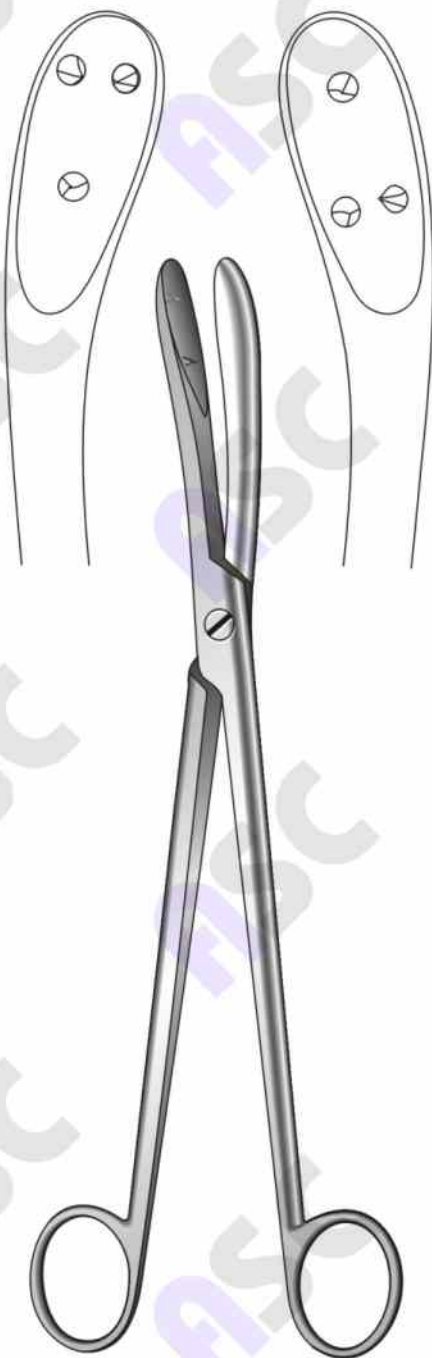

Boer
32-4455-29
29 cm / 11½"
Craniotomy forceps



Braun
32-4460-32
32.5 cm / 13"
Decapitating hook



32-4465-27



32-4466-27



Dubios
27.5 cm / 10¾"
Decapitating (embryotomy) scissors

Obstetrics, Scalp Flap Forceps
Geburtshilfe, Kopfsch Wartenzangen
Obstetrique, Pinzas Para Paricraneo



Green-Armytage

32-4470-22

22 cm / 8 1/4"

Caesarean section haemostatic forceps,
for edges of the transverse incision in the
lower segment



Sellheim

32-4475-30

30 cm / 12"

Obstetric lever



Willet

32-4480-19

19 cm / 7 1/2"

Scalp flap forceps



Gauss

32-4485-26

26 cm / 10 1/4"

Scalp flap forceps

Ovum Curettes, Abortion Scoops
Abortusküretten, Abortuslöffel
Curetas para aborto, Chucharillas para aborto



Gyneco

32-4490-00	4 mm Ø
32-4491-00	6 mm Ø
32-4492-00	8 mm Ø
32-4493-00	10 mm Ø
32-4494-00	12 mm Ø
32-4495-00	14 mm Ø
32-4496-00	16 mm Ø



Smellie

32-4501-33	33 cm / 13"
------------	-------------



Wallich

32-4505-42	42 cm / 16 1/2"
------------	-----------------



Blunt

32-4506-00	12 mm
32-4507-00	14 mm
32-4508-00	16 mm
32-4509-00	20 mm

Ovum Curettes, Abortion Scoops
Abortusküretten, Abortuslöffel
Curetas para aborto, Chucharillas para aborto



Cuzzi
30 cm / 12"



Toothed back



32-4515-30
14.5 mm
Blunt



32-4520-30
18 mm
Blunt



32-4525-30
21 mm
Blunt



Danis
32-4530-24
24 cm / 9½"



Alphabetical Index



Alphabetical Index

Abortion Scoops	109	COLLIN Uterine Elevating Forceps	76
ALAN PARKS Rectal Specula	4	COLLIN Vaginal Specula	39, 41
ALEXANDER Uterine Biopsy Forceps	88	COLLYER Pelvimeters	93
AMBER-HAWKINS Uterine Dilators	60	Cone Knives	79
Amniotome	67	Conization Knife	79
ANDERSON-GRAEME Proctoscopes	6	Connector, Uterine Suction	81
Aspirating Curettes	81	COOK Rectal Specula	1
AUVARD Vaginal Specula	52, 54	COXETER Metal Catheters	37
AUVARD-BERLIND Vaginal Specula	52	Cranioclast	101
Auvard-STEINER Vaginal Specula	52	Craniotomy Forceps	106
AYRE Conization Knife	79	Curettes, Aspirating	81
BABY-TISHLER Cervical Biopsy Forceps	91	Curettes, Ovum	108
BAILEY-WILLIAMSON Obstetrical Forceps	98	Curettes, Specimen	81
BAKES Gall Duct Dilators	23	Curettes, Suction	80
BALLENTINE Hysterectomy Forceps	73	Curettes, Uterine	80-84
BALLENTINE-HEANEY Hysterectomy Forceps	73	Curettes, Uterine Biopsy	80
BARNES-NEVILLE Obstetrical Forceps	99	CUSCO FIXE Vaginal Specula	40
BARR Grooved Directors	14, 15	CUSCO PLIANT Vaginal Specula	40
BARR Hooks	15	CUSCO Vaginal Specula	38, 39
BARR Rectal Specula	4	CUZZI Ovum Curettes	109
BARRETT Tenaculum Forceps	66	CZEMY/BRAUN Tenaculum Forceps	70
BARR-SHUFORD Proctoscopes	5	CZERNY Gall Stone Forceps	20
BARTON Obstetrical Forceps	98, 100	CZERNY Rectal Specula	1
Basiotribe	101	CZERNY Tenaculum Forceps	70
BEACHAM Amniotome	67	DANIS Abortion Scoops	109
BENSAUDE Proctoscopes	7	DARTIGUES Uterine Elevating Forceps	75
BERGER Cervical Biopsy Forceps	89	DEBARKER Biopsy Forceps	89
BERLIND-AUVARD Vaginal Specula	52	DE LEE Universal Retractor	48
Biopsy Curettes, Uterine	80	Decapitating Hook	106
Biopsy Forceps, Cervical	89, 91	Decapitating Scissors	106
Biopsy Forceps, Uterine	86-88, 90, 92	DELEE Pelvimeters	93
Biopsy Specimen Forceps	13	DEMELIN SUZOR Obstetrical Forceps	100
Bladder Neck Spreaders	29	DENNEN-HAWKS Obstetrical Forceps	98
Bladder Retractors	28, 30	Depressors	77
Blade with Weight	53	DESJARDINS Gall Duct Dilators	23
BLAKE Gall Stone Forceps	18	DESJARDINS Gall Stone Forceps	19
BLAKE-MAYO Gall Stone Forceps	18	DESJARDINS Gall Stone Scoops	24
BLANCHARD Hooks	15	DEWEY Obstetrical Forceps	98
BOER Craniotomy Forceps	106	Dilating Bougie	35
BOERMA Obstetrical Forceps	96	Dilating Bougies	62
Bougies, Dilating	62	Dilators for Gall Duct	23
BOZEMAN Dressing Forceps	74	Dilators, Uterine	60, 61, 63
BOZEMAN-DOUGLAS Dressing Forceps	74	Directors	33
BRAUN Cranioclast	101	Directors, Grooved	14, 15
BRAUN Decapitating Hook	106	DITTEL Dilating Bougie	35
BRAUN Tenaculum Forceps	65, 70	DOREN-VAN Uterine Biopsy Forceps	88
BRAUN Uterine Depressors	77	DOUAY Cervical Biopsy Forceps	89
BRAUN-SIMPSON Obstetrical Forceps	96	DOUAY COLLIN Cervical Biopsy Forceps	89
BREISKY Pelvimeters	94	DOUGLAS-BOZEMAN Dressing Forceps	74
BREISKY Vaginal Specula	51	DOYEN Myoma Instruments	78
BRINKERHOFF Rectal Specula	3	DOYEN Uterine Polypus Forceps	71
BUIE Grooved Directors	15	DOYEN Vaginal Specula	48, 51
BUIE-SMITH Retractors	4	Dressing Forceps	74
BURKE Cervical Biopsy Forceps	91	DUBIOS Decapitating Scissors	106
Caesarean Section Haemostatic Forceps	107	DUBIOS Embryotomy Scissors	106
Capsule Forceps	27	Duct Dilators for Gall	23
Catheter Guide	37	DUPLAY Tenaculum Forceps	67
Catheters, Metal	37, 62	Elevating Forceps, Uterine	75, 76
Cervical Biopsy Forceps	89, 91	ELSASSER Nephrostomy Forceps	22
Cervical Specimen Forceps	89, 91	Embryotomy Scissors	106
CHELSEA EATON Proctoscopes	7	EMMET Uterine Tenaculum Hook	79
CHERON Dressing Forceps	74	Endospecula	57, 58
CHILD Hernia Directors	33	Extractor, Head	98
Circumcision Clamps	32	FANSLER-IVES Proctoscopes	5
Circumcision Instruments	32	FAURE Uterine Biopsy Forceps	86
Clamp Forceps, Vaginal	73	FEMALE Metal Catheters	37
Clamps, Vasectomy Towel	10	FENSLER Proctoscopes	5
Clamps, Circumcision	32	FERGUSON-HILL Rectal Specula	2
Clamps, Meatus	34	FERGUSON Gall Stone Scoops	24
CLUM Vaginal Specula	39	Fistula Hooks	79
CLUTTON Dilating Bougie	35	Fistula Probe	14
COLLIN Pelvimeters	94	FOERSTER Uterine Polypus Forceps	72

Alphabetical Index

Forcep, Rectal	14	Hernia Directors	33
Forceps, Biopsy Specimen	13	Hernia Suction Tube	33
Forceps, Caesarean Section Haemostatic	107	HEYWOOD-SMITH Rectal Forcep	14
Forceps, Capsule	27	HILL-FERGUSON Rectal Specula	2
Forceps, Cervical Biopsy	89, 91	HIRSCHMANN Proctoscopes	7
Forceps, Cervical Specimen	89, 91	HIRST's Placenta Forceps	105
Forceps, Craniotomy	106	Hook, Decapitating	106
Forceps, Dressing	74	Hook, Uterine Tenaculum	79
Forceps, Foreign Body	32	Hook, Vasectomy	10
Forceps, Gall Stone	18-21	Hooks	15
Forceps, Handle for Biopsy	13	Hooks, Fistula	79
Forceps, Hemorrhoidal	11, 12	HUBER Universal Handle	92
Forceps, Hysterectomy	73	HUBER Uterine Biopsy Forceps	92
Forceps, IUP Grasping	11	HULKA Forceps	65
Forceps, Kidney Stone	16, 17	Hysterectomy Forceps	73
Forceps, Lithotomy	34	Intra Uterine Pessary	11
Forceps, Midwifery	95-100	IOWA Tenaculum Forceps	68
Forceps, Nephrostomy	22	IUP Grasping Forceps	11
Forceps, Obstetrical	95-100, 105	IVES-FANSLER Proctoscopes	5
Forceps, Over Street	21	J.O.M.W Type Uterine Curettes	84
Forceps, Ovum	102-104	JACKSON Vaginal Specula	49
Forceps, Placenta	105	JACOBS Tenaculum Forceps	69
Forceps, Rectal Biopsy Specimen	13	JARCHO Tenaculum Forceps	66
Forceps, Scalp Flap	107	JAYLE Vaginal Specula	53
Forceps, Sponge	74	KALLMORGAN Vaginal Specula	50
Forceps, Tenaculum	64-70	KELLY Proctoscopes	6
Forceps, Uterine Biopsy	86-88, 90, 92	KELLY Uterine Polypus Forceps	71
Forceps, Uterine Elevating	75, 76	KEVORKIAN Suction Curettes	80
Forceps, Uterine Polypus	71	KEVORKIAN Uterine Biopsy Forceps	90, 92
Forceps, Vaginal Clamp	73	KEVORKIN-PACIFIC Uterine Biopsy Forceps	90
Forceps, Vasectomy	10	KEY Hernia Directors	33
Foreign Body Forceps	32	Kidney Stone Forceps	16, 17
FRIEDMAN Wound Spreader	59	KIELLAND Obstetrical Forceps	95, 97
Gall Duct Dilators	23	KIELLAND-LUIKART Obstetrical Forceps	97
Gall Stone Forceps	18-21	Knife, Conization	79
Gall Stone Probes	24	Knives, Cone	79
Gall Stone Scoops	24, 25	KOCHER Bladder Retractors	31
GARBRIEL Proctoscopes	6	KOERTE-LUER Gall Stone Scoops	25
GARLAND Hysterectomy Forceps	73	KOGAN Endospecula	57
GARRIGUE Vaginal Specula	52	KRAUSE Uterine Biopsy Forceps	92
GAUSS Scalp Flap Forceps	107	KRISTELLER Vaginal Specula	44-47
GAYLOR-THOMS Uterine Biopsy Forceps	86, 87	LARRY Grooved Directors	14
GELLHORN Uterine Biopsy Forceps	86	LATERAL Vaginal Retractor	57
GELPI Wound Spreader	59	LEGUEU Bladder Retractors	30, 31
GIVNEY-MC Hemorrhoidal Forceps	11	LEUR Rectal Forcep	14
Goniometer	94	Lever, Obstetric	107
GOODELL Tenaculum Forceps	64	LEWKOWITZ Lithotomy Forceps	34
GOSSET Bladder Retractors	28	LEWKOWITZ Ovum Forceps	103
GRAEME-ANDERSON Proctoscopes	6	LISTER Dilating Bougie	35
Grasping Forceps, IUP	11	Lithotomy Forceps	34
GRAVE SPECIAL Vaginal Specula	42	LUER-KOERTE Gall Stone Scoops	25
GRAVE Vaginal Specula	40, 42	LUIKART Obstetrical Forceps	97
GRAVE'S WIDE VIEW Vaginal Specula	41	LUIKART-KIELLAND Obstetrical Forceps	97
GREEN-ARMYTAGE Haemostatic Forceps	107	LUIKART-MCLEAN Obstetrical Forceps	98
Grooved Directors	14, 15	LUIKART-MCLEAN-TUCKER Obstetrical Forceps	98
Guide, Catheter	37	LUIKART-SIMPSONS Obstetrical Forceps	97
GUTTMANN Vaginal Specula	43	MALE Metal Catheters	37
GUYON Catheter Guide	37	MARKS-ST Retractors	8, 9
GUYON Dilating Bougie	36, 62	MATHIEU Foreign Body Forceps	32
GYNECO Ovum Curettes	108	MATHIEU Rectal Specula	1
Haemostatic Forceps	107	MATHIEU Vaginal Specula	50
Handle for Biopsy Forceps	13	MAYO Gall Duct Dilators	23
Handle, Universal	92	MAYO Gall Stone Scoops	24
HANK Uterine Dilators	63	MAYO-BLAKE Gall Stone Forceps	18
HAWKINS-AMBER Uterine Dilators	60	MC CLINTOCK Ovum Forceps	103
HAWKS-DENNEN Obstetrical Forceps	98	MC-GIVNEY Hemorrhoidal Forceps	11
Head Extractor	98	MCLEAN Obstetrical Forceps	97
HEANEY Hysterectomy Forceps	73	MCLEAN-LUIKART Obstetrical Forceps	98
HEANEY-BALLENTINE Hysterectomy Forceps	73	MCLEAN-TUCKER-LUIKART Obstetrical Forceps	98
HEGAR Uterine Dilators	60, 61	Meatus Clamps	34
Hemorrhoidal Forceps	11, 12	Metal Catheters	37, 62
HENROTIN Vaginal Specula	52	Midwifery (Obstetrical) Forceps	95-100

MILLIN Bladder Neck Spreaders	29	RICORD Rectal Specula	3
MILLIN Bladder Retractors	30	RIGBY Wound Spreader	59
MILLIN Capsule Forceps	27	ROSSOR Hooks	15
MILLIN Suction Tube	33	SAENGER Ovum Forceps	104
MIXTER Gall Stone Forceps	19	SAKURAI's Vaginal Speculum	39
MOD. MUENCHEN Suction Curettes	80	SAWYER Rectal Specula	2
MODELL-TUBINGER Gall Stone Forceps	21	Scalp Flap Forceps	107
MOGEN Circumcision Instruments	32	SCHERBACK Vaginal Specula	55
MOORE-STAUDE Tenaculum Forceps	65	SCHROEDER Tenaculum Forceps	65, 68
MORGAN-NAUNTON Proctoscopes	7	SCHROEDER Uterine Scoops	85
MORGAN-TISCHLER Uterine Biopsy Forceps	92	SCHUBERT Uterine Biopsy Forceps	86, 87
MORGAN-TISHLER Cervical Biopsy Forceps	91	SCHUHMACHER Uterine Biopsy Forceps	92
MOYNIHAN Gall Stone Scoops	24	Scissors, Decapitating	106
MUENCHEN MODEL Gall Stone Scoops	25	Scissors, Embryotomy	106
MURLESS Obstetrical Forceps	98	Scoops for Gall Stone	24, 25
MUSEUX DROITE Tenaculum Forceps	69	Scoops, Abortion	109
MUSEUX Tenaculum Forceps	69	Scoops, Uterine	85
Myoma Instruments	78	SEGOND Myoma Instruments	78
NAGELE Obstetrics Perforator	101	SEIFFERT Uterine Biopsy Forceps	92
NAGELE Obstetrical Forceps	95	SELLHEIM Obstetric Lever	107
NAUNTON-MORGAN Proctoscopes	7	SEMM Vaginal Specula	40
Neck Spreaders	29	SHIRODKA MAGENDIE Uterine Elevating Forceps	76
Nephrostomy Forceps	22	SHUFORD-BARR Proctoscopes	5
NEVILLE-BARNES Obstetrical Forceps	99	SIMON Fistula Hooks	79
NOTO Uterine Polypus Forceps	71	SIMON Uterine Scoops	85
NOVAK Suction Curettes	80	SIMPSON Obstetrical Forceps	96
O' CONNOR-O' SULLIVAN Endospecula	58	SIMPSON-BRAUN Obstetrical Forceps	96
O' SULLIVAN-O' CONNOR Endospecula	58	SIMPSONS-LUIKART Obstetrical Forceps	97
Obstetric Lever	107	SIMS Rectal Specula	1, 2
Obstetrical (Midwifery) Forceps	95-100	SIMS Tenaculum Forceps	64
Obstetrical Forceps	105,107	SIMS Uterine Curettes	84
Obstetrics Perforator	101	SIMS Uterine Depressors	77
Obturator	5	SIMS Uterine Sounds, Depressors	77
Over Street Forceps	21	SIMS Vaginal Specula	44, 49
Ovum Curettes	108	SIMS-BUMM-RECAMIER Uterine Curettes	82
Ovum Forceps	102-104	SKENE Tenaculum Forceps	67
PACIFIC-KEVORKIN Uterine Biopsy Forceps	90	SMELLIE Obstetrics Perforator	101
PEDERSON Vaginal Specula	40	SMELLIE Ovum Curettes	108
PELKMANN Gall Stone Forceps	20	SMITH Vaginal Retractor	58
Pelvimeters	93, 94	SMITH-BUIE Retractors	4
Pelvis Retractors	9	SMITH-HEYWOOD Rectal Forcep	14
PENNINGTON Proctoscopes	5	SOMER Uterine Elevating Forceps	75
Perforator, Obstetrics	101	SOONAWALA MODIFIED Vaginal Specula	53
Perineal Retractor	8	SOONAWALA Vaginal Specula	53
Pessary, Intra Uterine	11	Sounds, Uterine	77
PIPER Obstetrical Forceps	96	Specimen Curette	81
Placenta Forceps	105	Specimen Forceps, Cervical	89, 91
Polypus Forceps, Uterine	71	Specula, Vaginal	38-52, 54-56
POZZI PALMER Tenaculum Forceps	66	Speculum, Vaginal	39, 52-55
POZZI Tenaculum Forceps	65	Sponge Forceps	74
PRATT Grooved Directors	15	Spreader, Wound, Self-retaining	59
PRATT Hooks	15	Spreaders, Bladder Neck	29
PRATT Rectal Specula	3	STAUDE-MOORE Tenaculum Forceps	65
PRATT Tenaculum Forceps	70	STEINER-AUVARD Vaginal Specula	52
PRATT Uterine Dilators	61	STEWART Hooks	15
Probe, Fistula	14	STILLE Gall Stone Forceps	21
Probe, Uterine	77	ST-MARKS Pelvis Retractors	9
Probes for Gall Stone	24	ST-MARKS Retractors	8
Proctoscopes	5-7	STOCKMANN Meatus Clamps	34
Prostatic Retractors	26	Stone Forceps, Gall	18-21
RAMPLEY Sponge Forceps	72	Stone Forceps, Kidney	16, 17
RANDALL Kidney Stone Forceps	16	STRAUSS Meatus Clamps	34
RANDELL Suction Curettes	80	Suction Connector, Uterine	81
RECAMIER-SIMS-BUMM Uterine Curettes	82	Suction Curettes	80
Rectal Biopsy Specimen Forceps	13	Suction Tube	33, 81
Rectal Forcep	14	Suction Tubes on Blades	42, 43
Rectal Specula	1-4	SUMIKOSHI Retractors	7
Retractors	4, 7-9, 26, 28, 30	TARNIER Basiotribe	101
Retractors, Bladder	28, 30	TARNIER Obstetrical Forceps	99
Retractors, Pelvis	9	TEALE Hernia Directors	33
Retractors, Perineal	8	TEALE Tenaculum Forceps	68
Retractors, Prostatic	26	Tenaculum Forceps	65-70

A large area of the page is covered by a light gray background with a pattern of overlapping semi-circles. Overlaid on this background are horizontal lines, creating a ruled area for notes.



Index by Code



Index by Code

Code	Page
13-3585-19	73
13-3585-21	73
13-3585-24	73
13-3590-19	73
13-3590-21	73
13-3590-24	73
13-3595-21	73
13-3596-21	73
13-3600-21	73
13-3601-21	73
14-3035-25	74
14-3040-26	74
14-3041-26	74
14-3045-24	74
14-3050-26	74
14-3055-25	72
14-3056-18	72
14-3056-20	72
14-3056-25	72
14-3057-25	72
14-3058-18	72
14-3058-20	72
14-3058-24	72
14-3060-18	72
14-3060-25	72
14-3065-18	72
14-3065-24	72
14-3066-18	72
14-3066-24	72
15-3425-29	9
15-3430-32	9
15-3435-32	9
15-3440-33	9
15-3441-33	9
15-3442-33	9
15-3445-33	9
15-3446-33	9
15-3447-33	9
15-3665-09	59
15-3665-11	59
15-3665-14	59
15-3665-16	59
15-3665-18	59
15-3670-18	59
15-3675-18	59
16-3035-37	11
16-3035-45	11
17-3085-34	94
30-4001-15	1
30-4002-15	1
30-4005-15	1
30-4006-15	1
30-4010-22	1
30-4011-22	1
30-4015-19	1
30-4016-19	1
30-4020-20	1
30-4021-20	1
30-4025-00	2
30-4026-00	2
30-4027-00	2
30-4030-21	2
30-4030-22	2
30-4035-19	2
30-4036-19	2

Code	Page
30-4040-23	2
30-4041-23	2
30-4045-23	2
30-4046-23	2
30-4050-24	2
30-4051-24	2
30-4055-00	3
30-4060-00	3
30-4061-00	3
30-4062-00	3
30-4065-20	3
30-4070-13	4
30-4075-20	4
30-4080-00	4
30-4085-00	5
30-4090-00	5
30-4095-00	5
30-4101-00	5
30-4105-00	5
30-4110-00	6
30-4111-00	6
30-4145-00	6
30-4146-00	6
30-4150-00	6
30-4151-00	6
30-4155-00	6
30-4160-00	6
30-4161-00	6
30-4162-00	6
30-4163-00	6
30-4164-00	6
30-4170-00	7
30-4175-00	7
30-4176-00	7
30-4177-00	7
30-4180-00	7
30-4181-00	7
30-4185-00	7
30-4186-00	7
30-4190-19	7
30-4195-00	8
30-4196-00	8
30-4197-00	8
30-4198-00	8
30-4215-12	10
30-4215-14	10
30-4220-00	10
30-4225-00	10
30-4226-00	10
30-4230-18	10
30-4240-22	11
30-4240-28	11
30-4245-00	11
30-4250-19	11
30-4255-00	12
30-4256-00	12
30-4260-00	12
30-4265-00	12
30-4270-00	12
30-4271-00	12
30-4275-17	12
30-4276-17	12
30-4280-00	12
30-4281-00	12
30-4285-00	13

Code	Page
30-4290-00	13
30-4291-26	13
30-4291-36	13
30-4291-40	13
30-4292-26	13
30-4292-36	13
30-4292-40	13
30-4293-26	13
30-4293-36	13
30-4293-40	13
30-4294-26	13
30-4294-36	13
30-4294-40	13
30-4295-26	13
30-4295-36	13
30-4295-40	13
30-4301-28	13
30-4301-35	13
30-4301-42	13
30-4302-28	13
30-4302-35	13
30-4302-42	13
30-4303-28	13
30-4303-35	13
30-4303-42	13
30-4304-28	13
30-4304-35	13
30-4304-42	13
30-4310-20	14
30-4315-21	14
30-4320-24	14
30-4325-18	14
30-4330-29	14
30-4335-17	15
30-4340-28	15
30-4345-18	15
30-4350-17	15
30-4355-25	15
30-4360-22	15
30-4361-22	15
30-4362-22	15
30-4365-22	15
30-4366-22	15
30-4370-17	15
31-3001-19	16
31-3002-19	16
31-3005-23	17
31-3006-23	17
31-3007-22	17
31-3008-22	17
31-3009-22	17
31-3015-23	17
31-3015-24	17
31-3025-20	18
31-3030-20	18
31-3035-20	18
31-3040-20	18
31-3045-22	19
31-3050-23	19
31-3051-23	19
31-3055-23	19
31-3056-23	19
31-3057-23	19
31-3058-23	19
31-3060-21	20

Code	Page
31-3065-24	20
31-3070-26	20
31-3075-25	21
31-3080-24	21
31-3085-23	21
31-3090-20	22
31-3095-20	22
31-3101-32	23
31-3105-30	23
31-3106-00	23
31-3107-00	23
31-3108-00	23
31-3109-00	23
31-3110-00	23
31-3111-00	23
31-3112-00	23
31-3113-00	23
31-3114-00	23
31-3115-00	23
31-3116-00	23
31-3117-00	23
31-3118-00	23
31-3120-28	23
31-3121-28	23
31-3122-28	23
31-3125-28	24
31-3126-28	24
31-3127-28	24
31-3130-30	24
31-3131-30	24
31-3132-30	24
31-3133-30	24
31-3135-13	24
31-3140-28	24
31-3145-21	24
31-3145-22	24
31-3145-23	24
31-3150-32	25
31-3151-32	25
31-3152-32	25
31-3153-32	25
31-3154-32	25
31-3155-32	25
31-3156-32	25
31-3157-32	25
31-3160-30	25
31-3161-30	25
31-3162-30	25
31-3163-30	25
31-3164-30	25
31-3170-21	26
31-3175-21	26
31-3180-22	26
31-3185-21	26
31-3510-36	62
31-4001-24	27
31-4005-23	27
31-4006-23	27
31-4007-24	27
31-4010-23	27
31-4015-00	28
31-4020-00	29
31-4025-00	29
31-4030-00	29
31-4035-00	30

Index by Code

Code	Page	Code	Page	Code	Page	Code	Page
31-4040-00	30	31-4180-02	36, 62	31-4255-00	35	31-4337-28	37
31-4045-00	30	31-4181-00	36, 62	31-4256-00	35	31-4338-28	37
31-4050-27	31	31-4182-00	36, 62	31-4257-00	35	31-4340-15	37
31-4055-26	31	31-4183-00	36, 62	31-4258-00	35	31-4341-15	37
31-4060-26	31	31-4184-00	36, 62	31-4259-00	35	31-4342-15	37
31-4065-20	32	31-4185-00	36, 62	31-4260-00	35	31-4343-15	37
31-4065-28	32	31-4186-00	36, 62	31-4261-00	35	31-4344-15	37
31-4070-20	32	31-4187-00	36, 62	31-4262-00	35	31-4345-15	37
31-4070-28	32	31-4188-00	36, 62	31-4263-00	35	31-4346-15	37
31-4075-07	32	31-4189-00	36, 62	31-4264-00	35	31-4347-15	37
31-4080-16	32	31-4190-00	36, 62	31-4265-00	35	31-4348-15	37
31-4085-00	32	31-4191-00	36, 62	31-4270-00	35	31-4349-15	37
31-4086-00	32	31-4192-00	36, 62	31-4271-00	35	31-4350-15	37
31-4087-00	32	31-4193-00	36, 62	31-4272-00	35	31-4351-15	37
31-4088-00	32	31-4194-00	36, 62	31-4273-00	35	31-4352-15	37
31-4089-00	32	31-4195-00	36, 62	31-4274-00	35	31-4353-15	37
31-4090-00	32	31-4196-00	36, 62	31-4275-00	35	31-4354-15	37
31-4091-00	32	31-4197-00	36, 62	31-4276-00	35	31-4355-15	37
31-4095-00	32	31-4198-00	36, 62	31-4277-00	35	31-4356-15	37
31-4096-00	32	31-4199-00	36, 62	31-4278-00	35	31-4357-15	37
31-4097-00	32	31-4200-00	36, 62	31-4279-00	35	31-4358-15	37
31-4101-00	33	31-4201-00	36, 62	31-4280-00	35	31-4360-20	37
31-4105-00	33	31-4202-00	36, 62	31-4285-00	35	31-4361-20	37
31-4110-00	33	31-4203-00	36, 62	31-4286-00	35	31-4362-20	37
31-4115-00	33	31-4204-00	36, 62	31-4287-00	35	31-4363-20	37
31-4120-26	34	31-4205-00	36, 62	31-4288-00	35	31-4364-20	37
31-4121-26	34	31-4206-00	36, 62	31-4289-00	35	31-4365-20	37
31-4125-20	34	31-4207-00	36, 62	31-4290-00	35	31-4366-20	37
31-4130-00	34	31-4208-00	36, 62	31-4291-00	35	31-4367-20	37
31-4135-00	34	31-4209-00	36, 62	31-4295-27	37	31-4368-20	37
31-4140-00	34	31-4210-00	36, 62	31-4296-27	37	31-4369-20	37
31-4145-00	35	31-4211-00	36, 62	31-4297-27	37	31-4370-20	37
31-4146-00	35	31-4212-00	36, 62	31-4298-27	37	31-4371-20	37
31-4147-00	35	31-4213-00	36, 62	31-4299-27	37	31-4372-20	37
31-4148-00	35	31-4214-00	36, 62	31-4300-27	37	31-4373-20	37
31-4149-00	35	31-4215-00	36, 62	31-4301-27	37	31-4374-20	37
31-4150-00	35	31-4216-00	36, 62	31-4302-27	37	31-4375-20	37
31-4151-00	35	31-4217-00	36, 62	31-4303-27	37	31-4376-20	37
31-4152-00	35	31-4218-00	36, 62	31-4304-27	37	31-4377-20	37
31-4153-00	35	31-4219-00	36, 62	31-4305-27	37	31-4378-20	37
31-4154-00	35	31-4220-00	36, 62	31-4306-27	37	31-4380-39	37
31-4155-00	35	31-4221-00	36, 62	31-4307-27	37	31-4385-35	37
31-4156-00	35	31-4222-00	36, 62	31-4308-27	37	31-4400-00	35
31-4157-00	35	31-4223-00	36, 62	31-4309-27	37	31-4401-00	35
31-4158-00	35	31-4224-00	36, 62	31-4310-27	37	31-4402-00	35
31-4159-00	35	31-4225-00	36, 62	31-4311-27	37	31-4403-00	35
31-4160-00	35	31-4226-00	36, 62	31-4312-27	37	31-4404-00	35
31-4161-00	35	31-4227-00	36, 62	31-4313-27	37	31-4405-00	35
31-4162-00	35	31-4228-00	36, 62	31-4320-28	37	31-4406-00	35
31-4163-00	35	31-4229-00	36, 62	31-4321-28	37	31-4407-00	35
31-4165-00	35	31-4230-00	36, 62	31-4322-28	37	31-4408-00	35
31-4166-00	35	31-4231-00	36, 62	31-4323-28	37	31-4409-00	35
31-4167-00	35	31-4232-00	36, 62	31-4324-28	37	31-4410-00	35
31-4168-00	35	31-4233-00	36, 62	31-4325-28	37	31-4411-00	35
31-4169-00	35	31-4234-00	36, 62	31-4326-28	37	31-4412-00	35
31-4170-00	35	31-4235-00	36, 62	31-4327-28	37	31-4413-00	35
31-4171-00	35	31-4236-00	36, 62	31-4328-28	37	31-4414-00	35
31-4172-00	35	31-4237-00	36, 62	31-4329-28	37	31-4415-00	35
31-4173-00	35	31-4238-00	36, 62	31-4330-28	37	31-4416-00	35
31-4174-00	35	31-4240-00	35	31-4331-28	37	31-4417-00	35
31-4175-00	35	31-4241-00	35	31-4332-28	37	31-4418-00	35
31-4176-00	35	31-4242-00	35	31-4333-28	37	31-4419-00	35
31-4177-00	35	31-4243-00	35	31-4334-28	37	31-4420-00	35
31-4180-00	36, 62	31-4245-00	35	31-4335-28	37	31-4421-00	35
31-4180-01	36, 62	31-4250-00	35	31-4336-28	37	31-4422-00	35

Code	Page
32-3001-00	38
32-3002-00	38
32-3003-00	38
32-3005-00	38
32-3006-00	38
32-3007-00	38
32-3010-00	38
32-3011-00	38
32-3012-00	38
32-3015-00	38
32-3020-00	38
32-3021-00	38
32-3022-00	38
32-3025-00	38
32-3026-00	38
32-3027-00	38
32-3030-00	38
32-3031-00	38
32-3032-00	38
32-3035-00	39
32-3040-00	39
32-3041-00	39
32-3042-00	39
32-3045-00	39
32-3046-00	39
32-3047-00	39
32-3050-00	39
32-3051-00	39
32-3052-00	39
32-3053-00	39
32-3054-00	39
32-3055-00	39
32-3060-00	40
32-3061-00	40
32-3062-00	40
32-3063-00	40
32-3064-00	40
32-3065-00	40
32-3066-00	40
32-3070-00	40
32-3071-00	40
32-3072-00	40
32-3073-00	40
32-3074-00	40
32-3080-00	40
32-3081-00	40
32-3082-00	40
32-3085-00	40
32-3086-00	40
32-3087-00	40
32-3090-00	40
32-3091-00	40
32-3095-00	41
32-3096-00	41
32-3097-00	41
32-3101-00	41
32-3102-00	41
32-3103-00	41
32-3105-00	41
32-3110-00	42
32-3111-00	42
32-3112-00	42
32-3115-00	42
32-3116-00	42
32-3117-00	42

Code	Page
32-3120-00	42
32-3121-00	42
32-3122-00	42
32-3125-00	42
32-3126-00	42
32-3127-00	42
32-3130-00	42
32-3131-00	42
32-3132-00	42
32-3135-00	43
32-3136-00	43
32-3137-00	43
32-3140-00	43
32-3145-00	43
32-3150-00	44
32-3151-00	44
32-3152-00	44
32-3155-00	44
32-3156-00	44
32-3157-00	44
32-3160-00	44
32-3161-00	44
32-3162-00	44
32-3165-00	44
32-3166-00	44
32-3167-00	44
32-3170-00	45
32-3171-00	45
32-3175-00	45
32-3176-00	45
32-3180-00	45
32-3181-00	45
32-3185-00	46
32-3186-00	46
32-3187-00	46
32-3190-00	46
32-3191-00	46
32-3192-00	46
32-3195-00	46
32-3196-00	46
32-3197-00	46
32-3201-00	47
32-3202-00	47
32-3203-00	47
32-3205-00	47
32-3206-00	47
32-3207-00	47
32-3210-00	47
32-3211-00	47
32-3212-00	47
32-3215-00	48
32-3220-00	48
32-3221-00	48
32-3222-00	48
32-3223-00	48
32-3224-00	48
32-3225-00	48
32-3226-00	48
32-3227-00	48
32-3228-00	48
32-3229-00	48
32-3230-00	48
32-3235-24	48
32-3240-00	49
32-3245-00	49

Code	Page
32-3250-00	49
32-3255-00	49
32-3256-00	49
32-3257-00	49
32-3258-00	49
32-3260-00	50
32-3261-00	50
32-3265-00	50
32-3266-00	50
32-3270-00	50
32-3271-00	50
32-3275-00	50
32-3276-00	50
32-3277-00	50
32-3278-00	50
32-3280-00	50
32-3281-00	50
32-3282-00	50
32-3283-00	50
32-3285-00	51
32-3286-00	51
32-3287-00	51
32-3288-00	51
32-3289-00	51
32-3290-00	51
32-3291-00	51
32-3292-00	51
32-3293-00	51
32-3294-00	51
32-3295-00	51
32-3301-00	51
32-3305-00	52
32-3306-00	52
32-3307-00	52
32-3310-00	52
32-3311-00	52
32-3312-00	52
32-3315-00	52
32-3320-00	52
32-3325-00	52
32-3330-00	53
32-3331-00	53
32-3335-00	53
32-3340-00	53
32-3345-00	54
32-3350-00	55
32-3355-00	55
32-3360-00	55
32-3365-00	55
32-3366-00	55
32-3367-00	55
32-3370-00	55
32-3371-00	55
32-3375-23	56
32-3376-00	56
32-3377-00	56
32-3378-00	56
32-3379-00	56
32-3380-22	56
32-3381-22	56
32-3382-00	56
32-3383-00	56
32-3384-00	56
32-3385-00	57
32-3390-24	57

Code	Page
32-3395-24	57
32-3401-18	57
32-3405-00	57
32-3406-00	57
32-3407-00	57
32-3408-00	57
32-3410-00	58
32-3415-00	58
32-3416-00	58
32-3417-00	58
32-3418-00	58
32-3420-10	59
32-3420-13	59
32-3440-00	60
32-3441-00	60
32-3444-00	60
32-3445-00	60
32-3446-00	60
32-3447-00	60
32-3448-00	60
32-3449-00	60
32-3450-00	60
32-3451-00	60
32-3452-00	60
32-3453-00	60
32-3454-00	60
32-3455-00	60
32-3456-00	60
32-3457-00	60
32-3458-00	60
32-3459-00	60
32-3460-00	60
32-3461-00	60
32-3462-00	60
32-3463-00	60
32-3464-00	60
32-3465-00	60
32-3466-00	60
32-3467-00	60
32-3468-00	60
32-3469-00	60
32-3470-00	60
32-3475-00	60
32-3476-00	60
32-3480-00	61
32-3481-00	61
32-3482-00	61
32-3483-00	61
32-3484-00	61
32-3485-00	61
32-3486-00	61
32-3487-00	61
32-3488-00	61
32-3489-00	61
32-3490-00	61
32-3491-00	61
32-3492-00	61
32-3493-00	61
32-3495-26	61
32-3496-26	61
32-3497-26	61
32-3498-26	61
32-3499-26	61
32-3501-26	61
32-3502-26	61

Index by Code

Code	Page
32-3503-26	61
32-3504-26	61
32-3505-20	61
32-3515-00	63
32-3516-00	63
32-3518-00	63
32-3519-00	63
32-3520-00	63
32-3525-00	63
32-3530-00	63
32-3535-00	63
32-3540-00	63
32-3545-00	63
32-3550-34	64
32-3555-29	64
32-3560-29	64
32-3565-17	65
32-3570-28	65
32-3575-25	65
32-3580-25	65
32-3585-25	65
32-3590-23	66
32-3595-23	66
32-3601-18	66
32-3605-20	66
32-3610-20	67
32-3615-26	67
32-3620-24	67
32-3625-24	68
32-3626-24	68
32-3630-23	68
32-3635-26	68
32-3640-21	69
32-3646-24	69
32-3647-24	69
32-3648-24	69
32-3649-24	69
32-3650-24	69
32-3651-24	69
32-3655-18	69
32-3655-20	69
32-3655-25	69
32-3660-28	70
32-3665-20	70
32-3670-26	70
32-3675-15	70
32-3680-27	71
32-3685-20	71
32-3690-32	71
32-3695-27	75
32-3701-23	75
32-3705-25	76
32-3710-26	76
32-3715-32	77
32-3720-32	77
32-3725-00	77
32-3730-25	77
32-3735-27	77
32-3740-26	77
32-3745-00	78
32-3750-14	78
32-3755-17	78
32-3760-23	79
32-3765-22	79
32-3770-22	79

Code	Page
32-3775-23	79
32-3776-23	79
32-3777-23	79
32-3778-23	79
32-3779-23	79
32-3785-30	80
32-3786-30	80
32-3790-23	80
32-3791-23	80
32-3795-27	80
32-3801-24	80
32-3802-24	80
32-3805-13	81
32-3810-00	81
32-3811-00	81
32-3812-00	81
32-3813-00	81
32-3814-00	81
32-3815-00	81
32-3816-00	81
32-3817-00	81
32-3820-00	81
32-3825-00	81
32-3830-00	81
32-3831-00	81
32-3832-00	81
32-3833-00	81
32-3834-00	81
32-3840-00	81
32-3845-26	82
32-3846-26	82
32-3847-26	82
32-3848-26	82
32-3849-26	82
32-3850-26	82
32-3851-26	82
32-3852-26	82
32-3853-26	82
32-3854-26	82
32-3855-26	82
32-3856-26	82
32-3857-26	82
32-3858-26	82
32-3865-31	82
32-3866-31	82
32-3867-31	82
32-3868-31	82
32-3869-31	82
32-3870-31	82
32-3871-31	82
32-3872-31	82
32-3873-31	82
32-3874-31	82
32-3875-31	82
32-3876-31	82
32-3877-31	82
32-3878-31	82
32-3879-31	82
32-3880-31	82
32-3881-31	82
32-3882-31	82
32-3885-26	82
32-3886-26	82
32-3887-26	82
32-3888-26	82

Code	Page
32-3889-26	82
32-3890-26	82
32-3891-26	82
32-3892-26	82
32-3893-26	82
32-3894-26	82
32-3895-26	82
32-3896-26	82
32-3897-26	82
32-3898-26	82
32-3905-31	82
32-3906-31	82
32-3907-31	82
32-3908-31	82
32-3909-31	82
32-3910-31	82
32-3911-31	82
32-3912-31	82
32-3913-31	82
32-3914-31	82
32-3915-31	82
32-3916-31	82
32-3917-31	82
32-3918-31	82
32-3919-31	82
32-3920-31	82
32-3921-31	82
32-3922-31	82
32-3925-26	82
32-3926-26	82
32-3927-26	82
32-3928-26	82
32-3929-26	82
32-3930-26	82
32-3931-26	82
32-3932-26	82
32-3933-26	82
32-3934-26	82
32-3935-26	82
32-3936-26	82
32-3937-26	82
32-3938-26	82
32-3945-31	82
32-3946-31	82
32-3947-31	82
32-3948-31	82
32-3949-31	82
32-3950-31	82
32-3951-31	82
32-3952-31	82
32-3953-31	82
32-3954-31	82
32-3955-31	82
32-3956-31	82
32-3957-31	82
32-3958-31	82
32-3959-34	82
32-3960-34	82
32-3961-34	82
32-3962-34	82
32-3965-26	82
32-3966-26	82
32-3967-26	82
32-3968-26	82
32-3969-26	82

Code	Page
32-3970-26	82
32-3971-26	82
32-3972-26	82
32-3973-26	82
32-3974-26	82
32-3975-26	82
32-3976-26	82
32-3977-26	82
32-3978-26	82
32-3985-31	82
32-3986-31	82
32-3987-31	82
32-3988-31	82
32-3989-31	82
32-3990-31	82
32-3991-31	82
32-3992-31	82
32-3993-31	82
32-3994-31	82
32-3995-31	82
32-3996-31	82
32-3997-31	82
32-3998-31	82
32-3999-34	82
32-4000-34	82
32-4001-34	82
32-4002-34	82
32-4010-28	84
32-4011-28	84
32-4012-28	84
32-4013-28	84
32-4014-28	84
32-4020-28	84
32-4021-28	84
32-4022-28	84
32-4023-28	84
32-4024-28	84
32-4025-28	84
32-4030-30	85
32-4031-30	85
32-4032-30	85
32-4033-30	85
32-4034-30	85
32-4035-30	85
32-4040-25	85
32-4041-25	85
32-4042-25	85
32-4043-25	95
32-4044-25	85
32-4045-25	85
32-4050-23	86
32-4055-21	86
32-4060-21	86
32-4060-29	86
32-4065-24	86
32-4070-22	87
32-4070-24	87
32-4075-26	87
32-4080-24	87
32-4085-25	88
32-4090-23	88
32-4091-23	88
32-4095-28	88
32-4101-00	89
32-4102-00	89

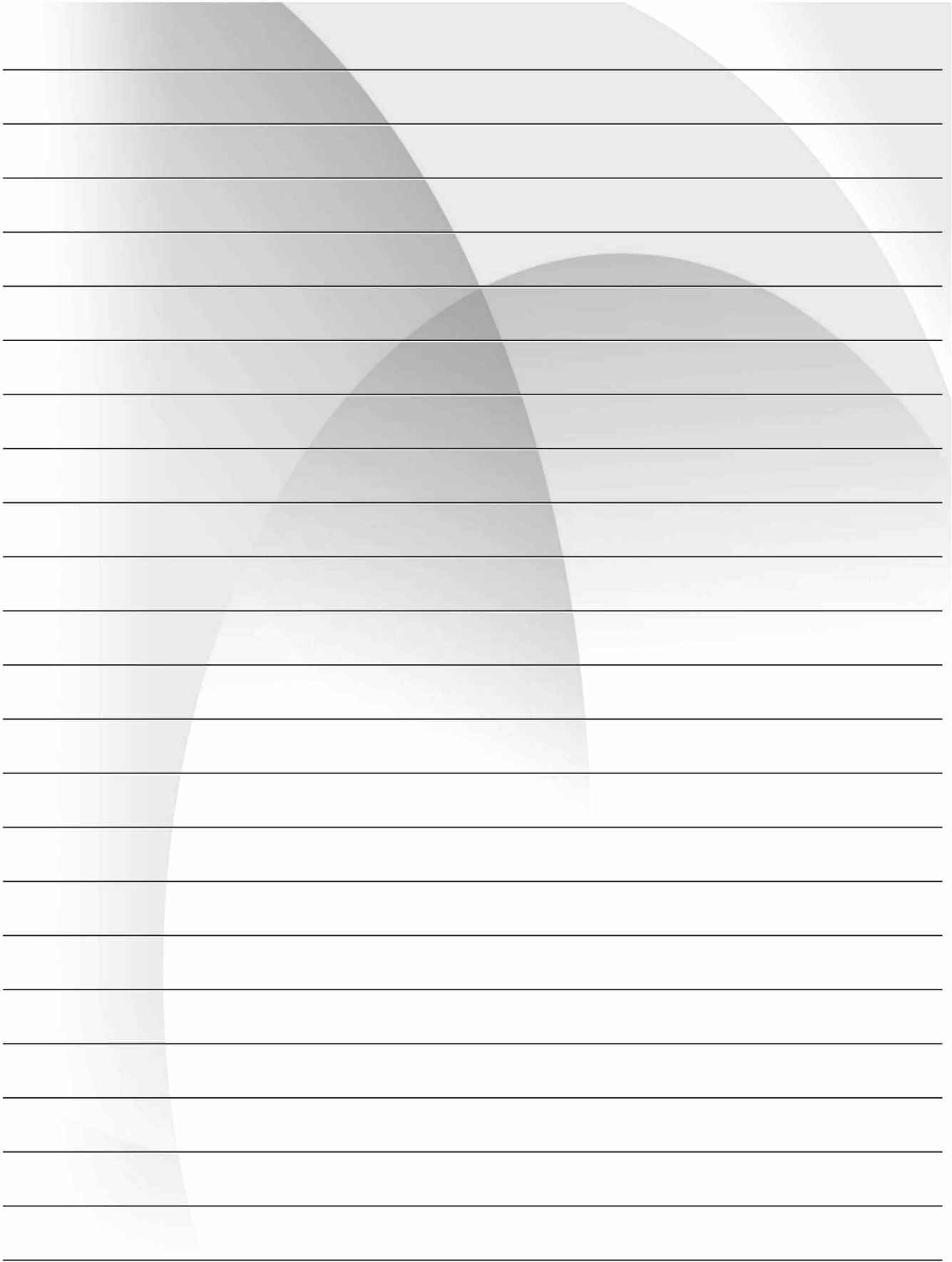

A large rectangular area for taking notes, featuring horizontal lines. The background is decorated with large, overlapping, semi-transparent grey circles.

ASC MEDICAL Surgical Instruments and Implants are guaranteed to be free of defects in materials and workmanship for life.

ASC MEDICAL Surgical Instruments and Implants that are determined to be defective will be replaced or repaired, at our discretion.

ASC MEDICAL Surgical Instruments and Implants not properly cared for or used for purposes not intended will not be covered.

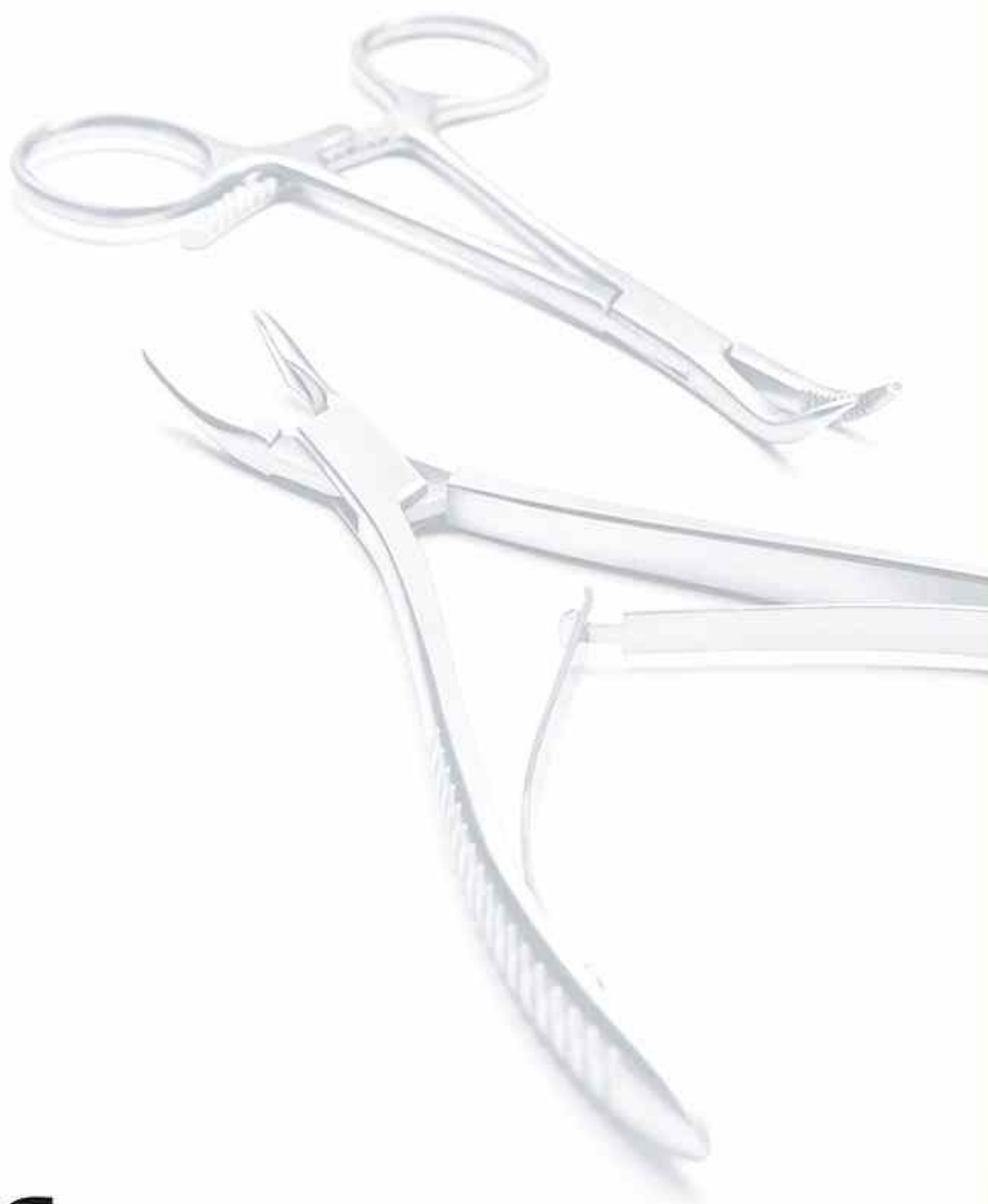

ASC Medical GmbH & Company KG
take-off GewerbePark 2
78579 Neuhausen o.E. | Tuttlingen, Germany

Phone: + 49 (0) 7467 - 94 960 46
Fax: + 49 (0) 7467 - 94 960 49
www.asc-med.com - info@asc-med.com