

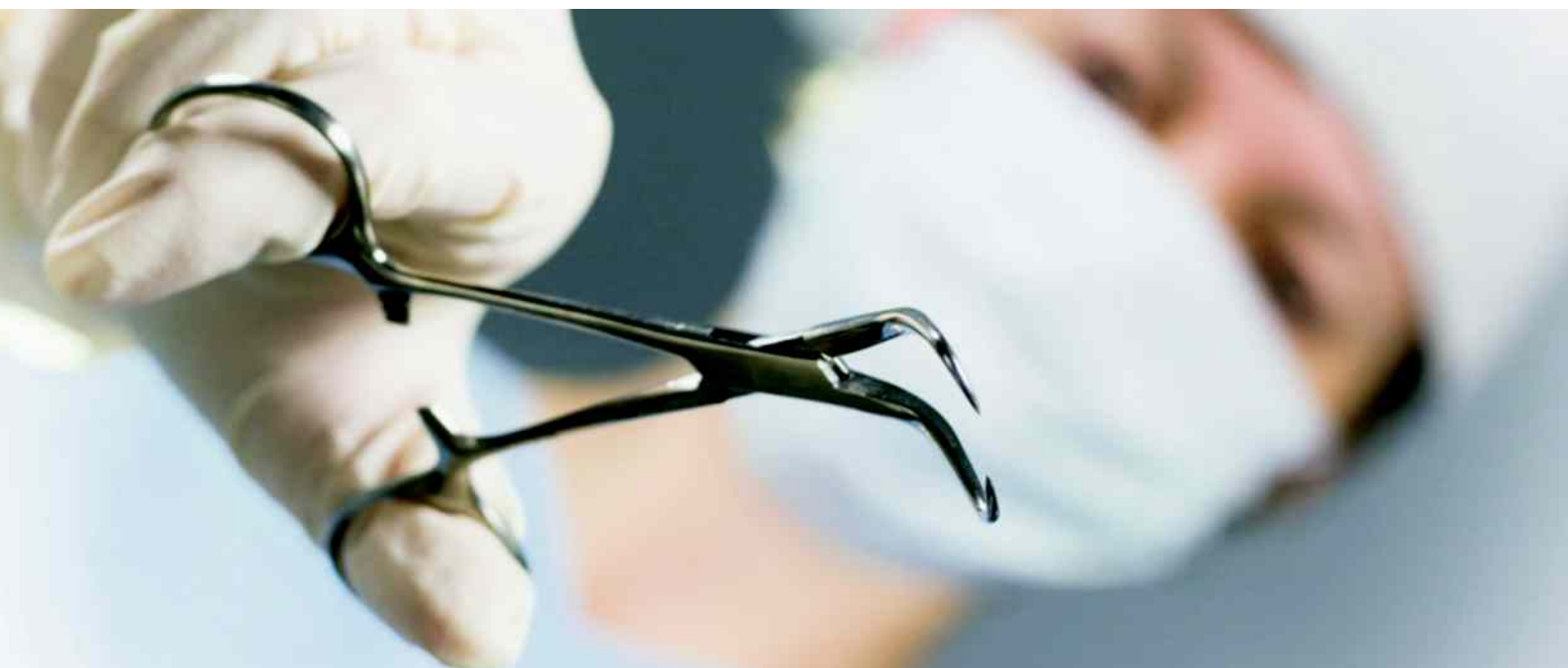

Orthopedic & Neurosurgical Instruments





Welcome to ASC Medical GmbH & Co. KG.

The company was founded by Kurt Bucher in the year 2003.

The **ASC MEDICAL** office is located in the heart of Southern Germany, Neuhausen / Tuttlingen.

ASC MEDICAL is dedicated to educating the market on new and improved techniques, implants and instrumentation.

Since the formation of **ASC MEDICAL**, we have dedicated ourselves of bringing instruments and implants at a competitive value to the Medical Market. We are proud of what we have achieved in the last 7 years and look forward to more of the same for many years to come.

When you purchase from **ASC MEDICAL**, you are guaranteed the best in quality and customer service. We not only meet your expectations, we exceed them!

This is what we set out to deliver and has since become known as the "**ASC MEDICAL Philosophy**".

On behalf of the **ASC MEDICAL** team members and our distribution partners, we thank you for your tremendous trust in the past. And with your support, we will continue to deliver the highest quality surgical instruments and implants on the market.

Kurt Bucher
President

Orthopedic	1-121
Neurosurgery	122-139

Special Note:

ASC is carrying the full range of over 18000 different surgical instruments.

Please do not hesitate to contact us for any instrument which you do not find in this catalogue.



Esmarch
21-3001-18
18 cm / 7"



Reiner
21-3005-18
18.5 cm / 7 1/4"



Hopkins
21-3010-20
20 cm / 8"



21-3015-21
21 cm / 8 1/4"

Bandage Scissors
Verbandscheren
Tijeras para vendajes



Smith
(Mod. USA)
21-3020-20
20 cm / 8"

Bruns
21-0398-24 Plain
23.5 cm / 9¼"
21-2025-24T Serrated
24 cm / 9½"
Open shanks with pin

Bruns
21-3025-24
23.5 cm / 9¼"
Closed shanks, serrated

Bruns
21-3030-24
24 cm / 9½"
Open shanks with pin, serrated



Lorenz
21-3035-23
23 cm / 9"

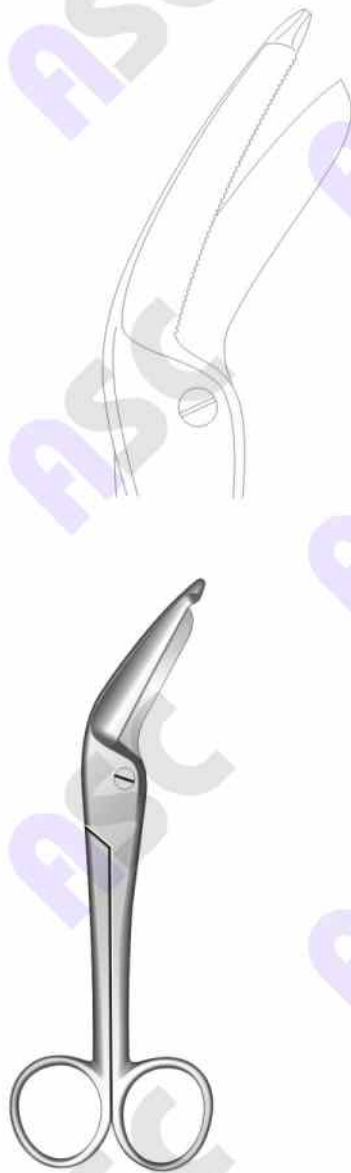

Excentric
21-3040-16 16 cm / 6 1/4"
21-3040-19 19 cm / 7 1/2"



Tomado
21-3045-24
24 cm / 9 1/2"
Undulated cutting edge

Bone Cutting Forceps
Knochenschneidezangen
Pinzas para cortar huesos



Seutin
23-3001-23
23 cm / 9"

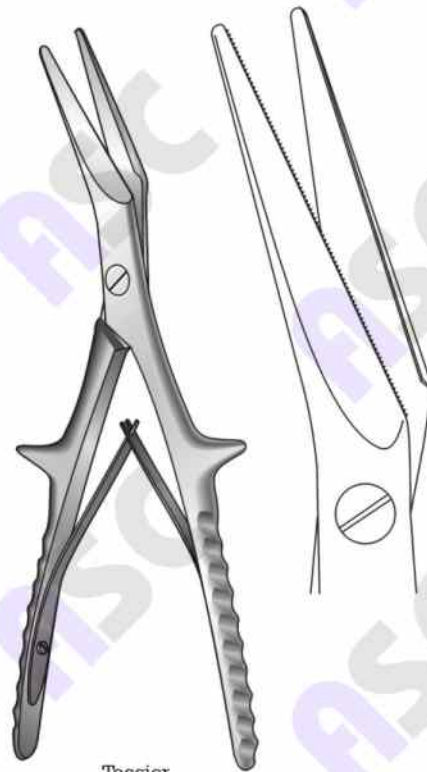

Tessier
23-3005-19
19.5 cm / 7 3/4"
1 serrated cutting edge

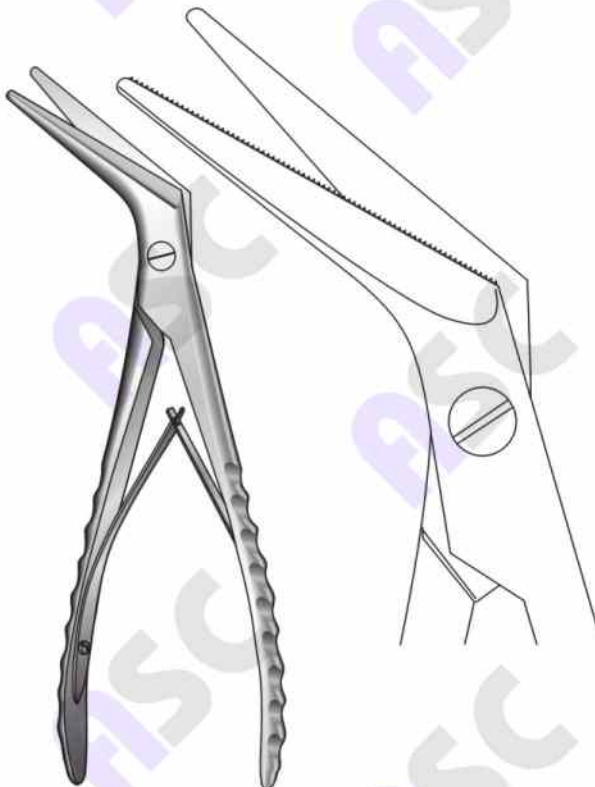

Tessier
23-3010-19
19 cm / 7 1/2"
1 serrated cutting edge

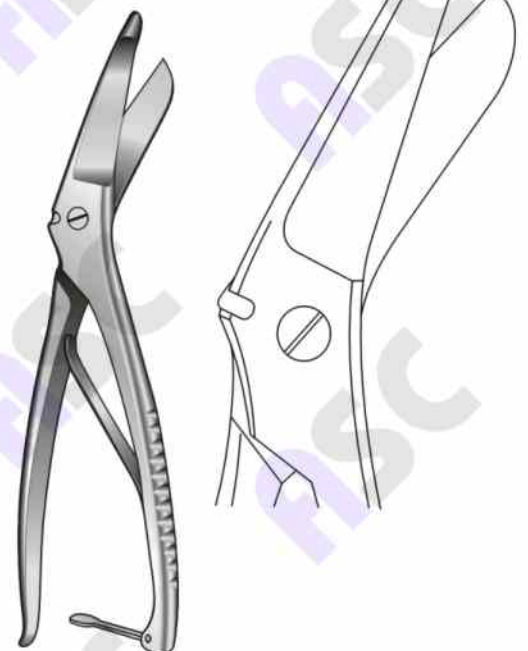

Universal
23-3015-20
20 cm / 8"

Plaster Cast Spreaders
Gipsspreizer
Separadores para yesos



Wolff

23-3020-18
18 cm / 7"

23-3020-24
24 cm / 9 1/2"

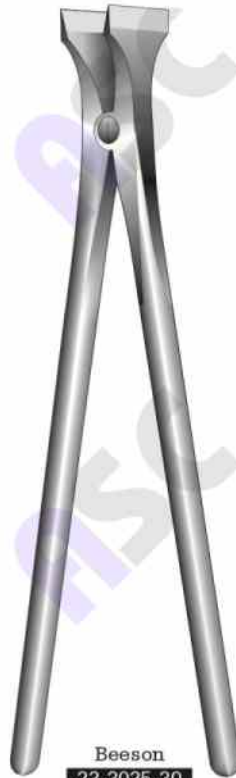

Beeson
23-3025-30
30 cm / 12"



Hennig
23-3030-28
28 cm / 11"



Haglund
23-3035-28
28 cm / 11"



23-3040-23
23 cm / 9"

Plaster of Paris Shears
Gipsscheren
Cizallas para vendajes enyesados

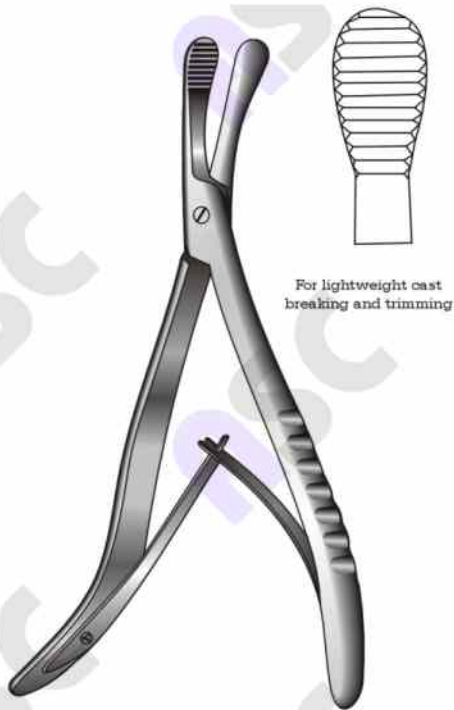

For lightweight cast breaking and trimming

Masson
23-3050-18
18 cm / 7"
Pediatric cast breaker
deep serrated tips



Stille
23-3055-24
24 cm / 9 1/2"



Stille-Mini
23-3060-20
Blade with reinforced back
23-3061-20
Blade without reinforced back
20 cm / 8"



Stille

23-3065-23
Blade with reinforced back
23-3066-23
Blade without reinforced back
23 cm / 9"

23-3065-26
Blade with reinforced back
23-3066-26
Blade without reinforced back
26 cm / 10 1/4"

23-3065-37
Blade with reinforced back
23-3066-37
Blade without reinforced back
37 cm / 14 1/2"

Mallets
Hammer
Martillos, Mazos



23-0317-01
16.5 cm / 6½"
140 gm / 5 oz, 20 mm Ø



Collin
23-0309-20
20 cm / 8"
220 gm / 7¾ oz, 30 mm Ø



Williger
24 cm / 9½"



23-0301-01
26 mm Ø
300 gm / 10½ oz

23-0301-02
28 mm Ø
340 gm / 12 oz

23-0301-03
30 mm Ø
400 gm / 14 oz



Lucae
19 cm / 7½"



23-0315-01
19 mm Ø
230 gm / 8 oz

23-0315-02
25 mm Ø
260 gm / 9 oz



Doyen
21 cm / 8½"

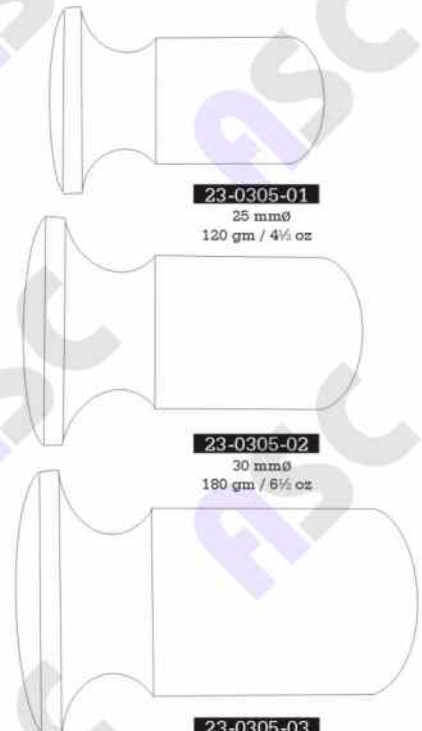

23-0305-01
25 mm Ø
120 gm / 4¼ oz

23-0305-02
30 mm Ø
180 gm / 6½ oz

23-0305-03
35 mm Ø
260 gm / 9 oz

Mallets
Hammer
Martillos, Mazos



Mead
320 gm, 26 mm Ø
23-3070-17
Solid
23-3071-17
17 cm / 6 3/4"
Ferrozell faces only, pair

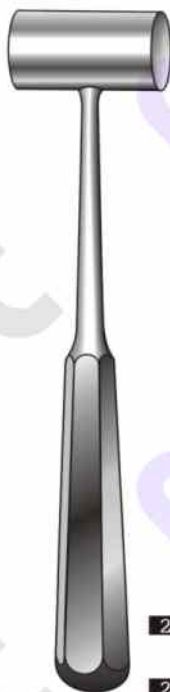

Partsch
22 mm Ø
23-3075-18
18 cm / 7"
200 gm
23-3076-16
16 cm / 6 1/4"
165 gm
23-3077-18
18 cm / 7"
220 gm



Heath
23-3080-18
18.5 cm / 7 1/4"
700 gm, 40 mm Ø
Cooper filled head



Autoclavable to
250°F (121°C)

Mallet Lightweight
19 cm / 7 1/2"
25 mm Ø
23-3085-19
140 gm
23-3086-19
Two replaceable nylon caps
Total weight: 7 oz.
Head weight: 4 oz



Autoclavable to
250°F (121°C)

Combination Mallet
19 cm / 7 1/2"
23-3090-19
Total weight: 9 oz
Head weight: 5 oz
26 mm Ø
23-3091-19
Total weight: 12 oz
Head weight: 8 oz
38 mm Ø
One side nylon cap



23-3095-00
1000 gm
23-3096-00
700 gm
23-3097-00
500 gm



Aluminium handle
23-3100-00
600 gm, 22 oz
Heavy
23-3101-00
300 gm, 11 oz



Cottle
23-3105-19
19 cm / 7 1/2"
240 gm, 30 mm Ø



Gerzog
23-3110-18
18 cm / 7"
250 gm



Kirk
23-3115-19
19 cm / 7½"
750 gm



Ombredanne
23-3120-24
24 cm / 9½"
550 gm, 40 mmØ



Bergmann
23-3125-24
24.5 cm / 9¾"
300 gm, 45 mmØ



Bergmann
23-3130-23
23.5 cm / 9¼"
300 gm, 30 mm Ø



Wagner
23-3135-23
23.5 cm / 9¼"
35 mm Ø



Metal head
23-3140-00
230 gm, 35 mm Ø



Plastic head
23-3141-00
32 gm, 35 mm Ø



Quisling
23-3145-00



23-3150-23
23.5 cm / 9¼"

Mallets
Hammer
Martillos, Mazos



23-3155-26 450 gm
23-3156-26 900 gm
26 cm / 10½"



23-3160-26
26 cm / 10½"
510 gm / 18 oz
30 mm Ø



23-3165-00
Head weight 550 gm
Total weight 750 gm
40 mm Ø



23-3170-00
Head weight 350 gm
Total weight 550 gm
35 mm Ø



23-3175-00
Head weight 300 gm
30 mm Ø



23-3180-00
Head weight 300 gm
Total weight 500 gm
30 mm Ø



23-3185-00
Medium size hammer
Full aluminum
Total weight 200 gm



23-3190-00
Small hammer aluminum handle
with stainless steel head
with rubber side (changeable)
Total weight 125 gm



15.5 cm / 6"

23-0299-02
2 mm \emptyset



23-0299-03
3 mm \emptyset



23-0299-04
4 mm \emptyset



23-0299-05
5 mm \emptyset



23-0299-06
6 mm \emptyset



23-0299-08
8 mm \emptyset



23-0299-10
10 mm \emptyset



Kienny
23-3195-17
17.5 cm / 7"



Trillat
23-3201-20 9 x 9 mm
23-3202-20 9 x 19 mm
20 cm / 8"



Cylindriques Double
23-3205-16 8 x 15 mm \emptyset
16 cm / 6 1/4"
23-3210-21 6 x 8 mm \emptyset
23-3211-21 10 x 12 mm \emptyset
21 cm / 8 1/4"

Bone Files
Knochenfeilen
Limas para huesos



23-3215-28
28 cm / 11"

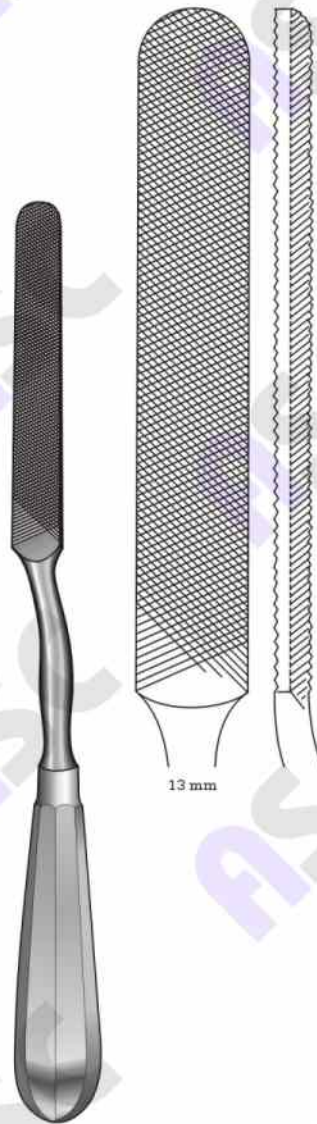

23-3220-24
24.5 cm / 9 3/4"

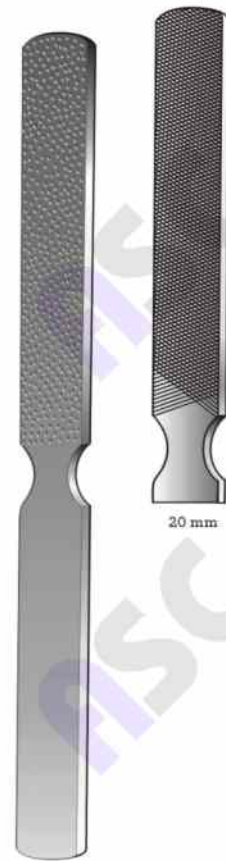

23-3225-22
22 cm / 8 3/4"

Bone Files, Bone Levers
Knochenfeilen, Knochenhebel
Limas para huesos, Elevadores para huesos



Putti
23-3230-30
30 cm / 12"



Putti
23-3235-27
27 cm / 10½"



Fomon
23-3240-21
21 cm / 8¼"
Double ended, fine and coarse teeth 4-side, convex and flat blades 8 mm width



Murphy-Lane
23-3245-30
30 cm / 12"
Bone skid

Nasal Rasps, Bone Files
Nasenraspeln, Knochenfeilen
Escofinas nasales, Limas para huesos



Trochlear
23-3250-17
17 cm / 6½"
Stainless steel



Maltz Improved
23-3255-21
21 cm / 8¼"
Double ended, forward and backward cutting, 8 mm width



Aufrecht
21 cm / 8¼"

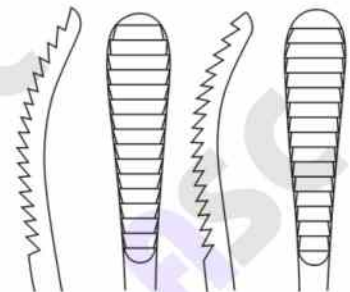

23-3260-21
Single ended forward cutting
9 mm width

23-3261-21
Single ended backward cutting
9 mm width



Maltz
18 cm / 7"
Single ended
10 mm width

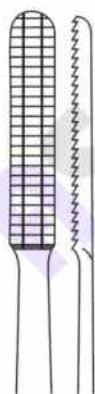

23-3265-18
34 x 7 mm
Backward cutting

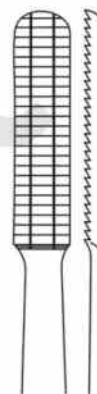

23-3266-18
34 x 7 mm
Forward cutting



Excision Arthroplasty
23-3270-17
17 cm / 6½"
Stainless steel

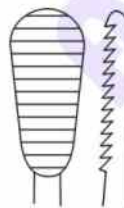

Joseph
23-3275-16
16 cm / 6¼"
Single ended, 8 mm at wide point, fine cross serrations

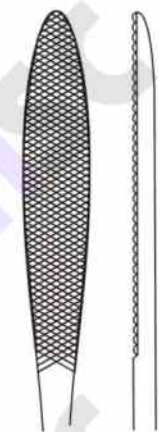

Bone Files
Knochenfeilen
Lima para huesos



Lewis Rasp
19 cm / 7½"

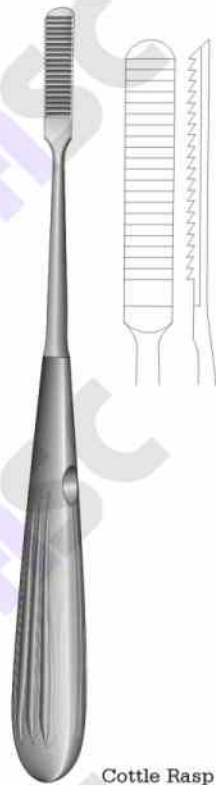
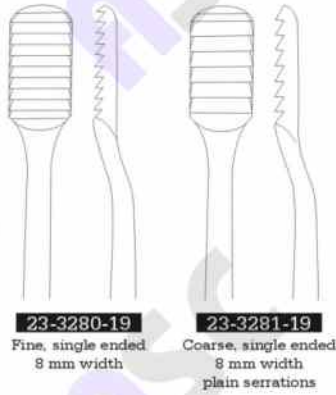

Cottle Rasp
23-3285-20
20.5 cm / 8"
Single ended, backward cutting
9 mm width
plain serrations

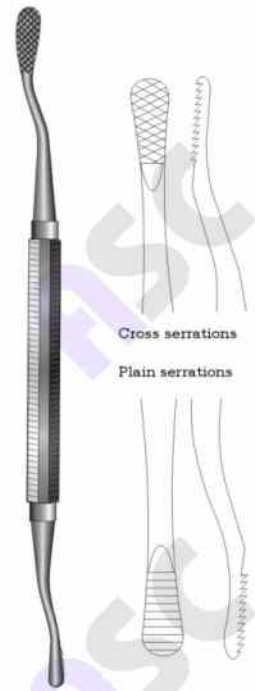

Miller-Colburn
23-3290-18
18 cm / 7"
Double ended, 5 mm width



Miller-Colburn
23-3295-18
18 cm / 7"
Double ended, cross serrations

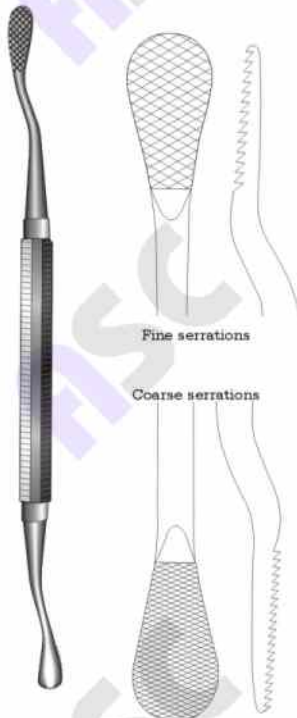
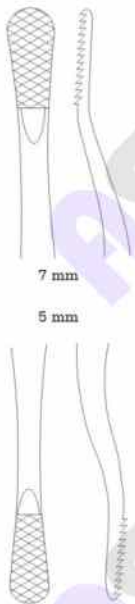

Miller-Colburn
23-3301-21
21.5 cm / 8½"
Double ended, 13 mm width
Cross serrations, for rapid shaping of bone

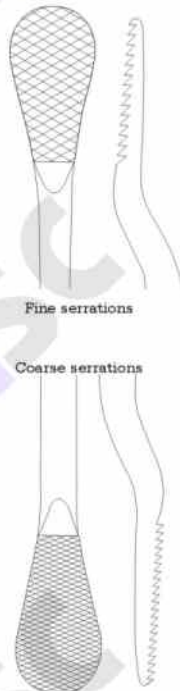

Polokoff Rasp
Double ended, plain serrations

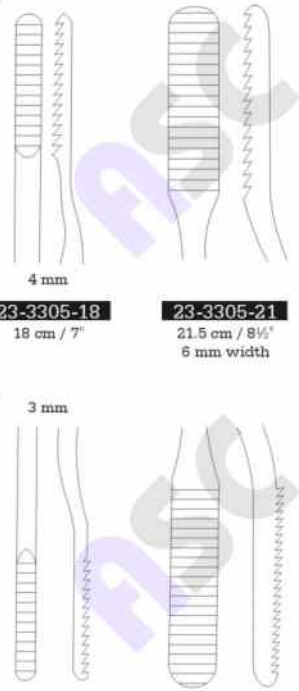

Bone Files
Knochenfeilen
Lima para huesos



Miller-Colburn

23-0591-01

18 cm / 7"

Double ended, plain serrations

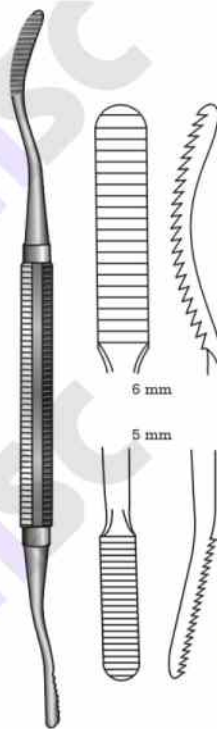

Miller-Colburn

23-0591-02

18.5 cm / 7 1/4"

Double ended, plain serrations

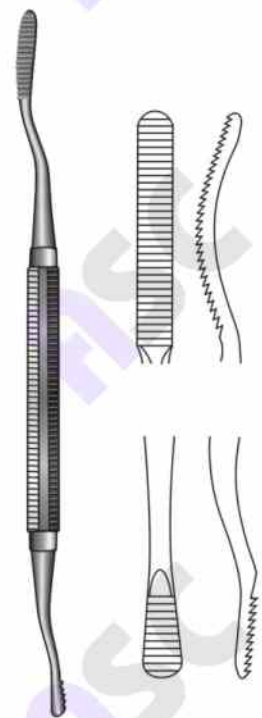

Miller-Colburn

23-0591-03

18 cm / 7"

Double ended, 5 mm width,
plain serrations

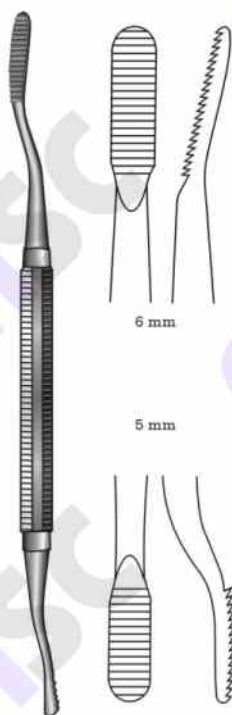

Miller-Colburn

23-0591-04

18 cm / 7"

Double ended, plain serrations

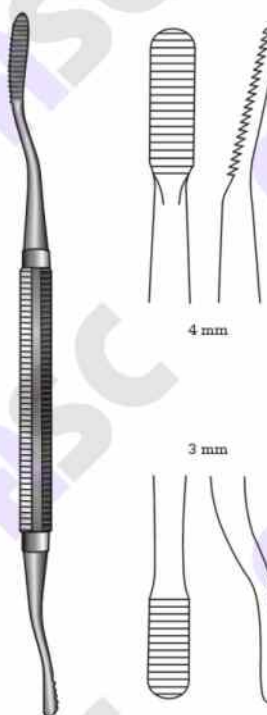

Miller-Colburn

23-3310-18

18 cm / 7"

Double ended

Bone Drills, Reamers, Wire Saws
Bohrinstrumente, Pfierme, Drahtsagen
Instrumentos para perforar, Escariador, Sierras de hilo



Adson
23-3315-15
15 cm / 6"
Drill guide



23-3320-14
14 cm / 5½"



23-3325-14
14 cm / 5½"



23-3330-30
30 cm / 12"
Straight ball spike



Perthes
23-3335-18
18 cm / 7"

Perthes
23-3340-21
21 cm / 8¼"

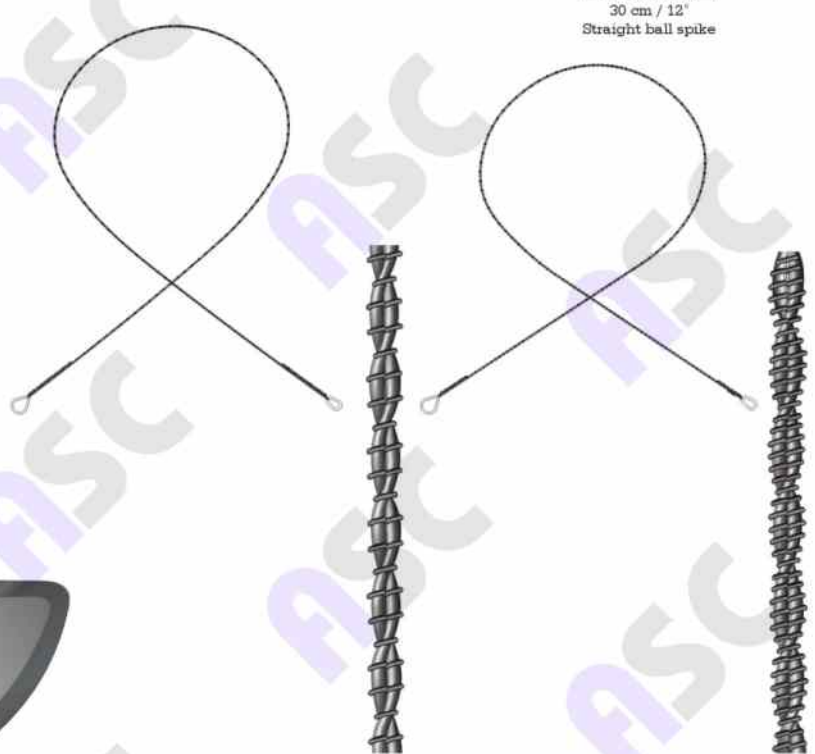

Olivecrona
23-3345-30 30 cm / 12"
23-3345-40 40 cm / 16"
23-3345-50 50 cm / 20"
23-3345-70 70 cm / 28"

Gigli
23-3350-30 30 cm / 12"
23-3350-40 40 cm / 16"
23-3350-50 50 cm / 20"
23-3351-50 50 cm / 20"
Fine, 6 wires twisted

Amputating, Resection Saws, Handles
Amputation-, Resektionssägen, Griffe
Sierras para amputación y resección, Mangos

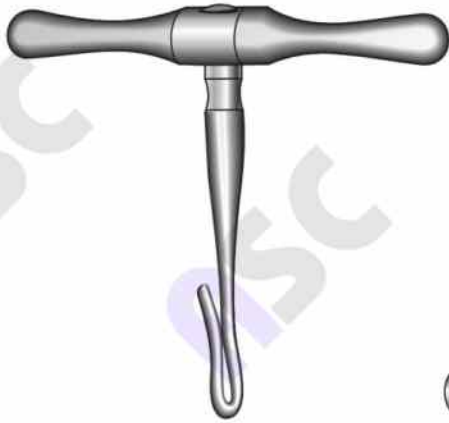

Gigli
23-3355-00
Handle



Gigli
23-3360-00
Handle with lock



Engel
23-3365-00



Lindemann
23-3370-20
20 cm / 8"



Langenbeck
23-3375-23
23 cm / 9"



Charriere
23-3380-35
35 cm / 14"



Charriere
23-3385-27 27 cm / 10 1/2"
23-3385-30 30 cm / 12"
23-3385-34 34 cm / 13 1/2"



Satterlee
23-3390-30
Blade 23 cm / 9"

Retractor, Amputation, Resection Saws
Wundhaken, Amputation- und Resektionssägen
Separadores, Sierras para amputación y resección



23-3395-30
30 cm / 11 3/4"
Blade 20 cm
Post mortem saw



Butcher
23-3401-00
Blade 45 cm
Post mortem saw



23-3405-00
Blade 40 cm
Post mortem saw



Bier
23-3410-42
42 cm / 16 1/2"
Length of blade 27 cm / 10 1/2"
Complete with one saw blade each
4 mm, 6 mm, 8 mm



Rust
23-3415-39
39 cm / 15 1/4"
Length of blade
Complete with one saw blade
each 8 mm, 12 mm

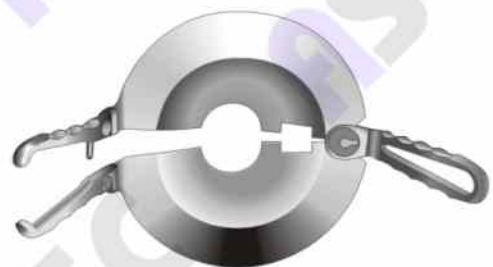

Percy
23-3420-00

Hand Drills
Handbohrapparate
Perforadoras a mano



Hudson
23-3435-00
Extension piece



23-3436-00
9 mm \emptyset
Conical burr



23-3437-00
14 mm \emptyset
Conical burr



23-3438-00
16 mm \emptyset
Spherical burr



23-3439-00
22 mm \emptyset
Spherical burr



23-3440-00
14 mm \emptyset
Flat trephine



23-3441-00
2 mm \emptyset
Twist drill



23-3442-00
13 mm \emptyset
Burr



23-3443-00
16 mm \emptyset
Burr

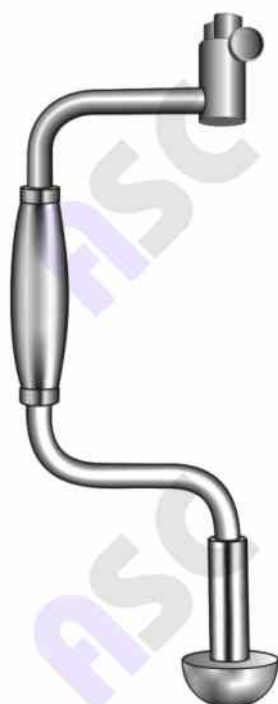

Hudson
27 cm / 10 $\frac{3}{4}$ "
23-3425-27
Complete set with Stainless steel handles
23-3426-27
Complete set with Ferrozell handles
23-3427-27
Complete set with Teflon handles

Hudson
27 cm / 10 $\frac{3}{4}$ "
23-3430-27
Brace only with Stainless steel handles
23-3431-27
Brace only with Ferrozell handles
23-3432-27
Brace only with Teflon handles



Stille-Sherman

23-3445-24
24 cm / 9½"

23-3445-00
Complete set



23-3450-00
2.5 mm Ø
Twist Drill

23-3451-00
3 mm Ø
Twist Drill

23-3452-00
3.5 mm Ø
Twist Drill



Stille

23-3455-20
20 cm / 8"

23-3455-00
Complete set



23-3456-00
2.5 mm Ø
Twist Drill

23-3457-00
3 mm Ø
Twist Drill

23-3458-00
3.5 mm Ø
Twist Drill

23-3459-00
4 mm Ø
Twist Drill

23-3460-00
10 mm Ø
Trephine

23-3461-00
5 mm Ø
Spherical Burr



23-3462-00
8 mm Ø
Spherical Burr

23-3463-00
12 mm Ø
Spherical Burr

23-3464-00
16 mm Ø
Spherical Burr

23-3465-00
1 mm Ø
Twist Drill

23-3466-00
1.5 mm Ø
Twist Drill

23-3467-00
2 mm Ø
Twist Drill

Hand Drills
Handbohrapparate
Perforadoras a mano



23-3470-00

Handle with chuck and key, accommodating up to 6.35 mm (1/4"), perforated, for inserting and extracting nails, guide pins and wire guide drills.



23-3476-00

Key only

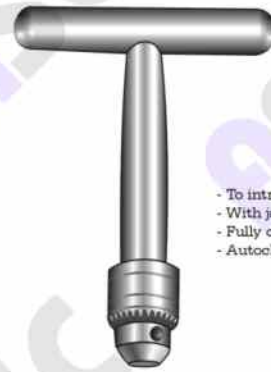

Pin Chuck

23-3475-15

15 cm / 6"

23-3475-14

14 cm / 5 1/2"

- To introduce bone pin
- With jacob chuck
- Fully cannulated
- Autoclaveable

6.35 mm

4.50 mm



23-3480-00

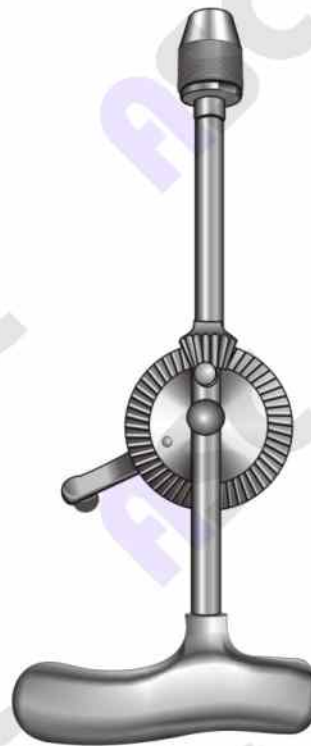

Moore

23-3485-00



23-3486-00

9 cm
3.2 mm Ø



23-3487-00

7 cm
3.2 mm Ø

23-3488-00

Complete with a set of twist drill ref. 23-3486-00, 23-3487-00

Hand Drills, Chuck
Handbohrapparate, Griffe
Perforadoras a mano, Mangos



Bunnell
23-3490-24
24 cm / 9½"



Ralk
23-3495-00 Normal shaft
23-3496-00 Long shaft



Jacobs
23-3501-00 Small
23-3502-00 Large
Stainless steel



23-3505-00
Key for Jacobs chuck
Stainless steel



23-3510-00 Small
23-3511-00 Large
Chuck chrome plated



23-3512-00
Key for
chrome plated chuck



23-3515-00
American model

Screw Drivers
Schraubenzieher
Destornilladores



Williams
23-3520-24
24 cm / 9½"

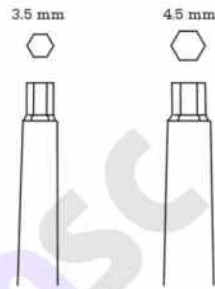
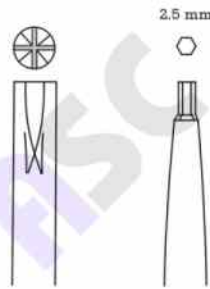
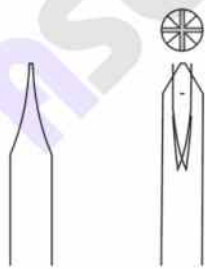

23-3565-00
Sleeve only

23-3566-00
2.5 mm



23-3525-17
17 cm / 6¾"
Ferrozell handle



Lane
23-3530-25
25 cm / 10"
Ferrozell handle



23-3535-17
17 cm / 6¾"
23-3535-25
25 cm / 10"
Ferrozell handle



23-3540-17
17 cm / 6¾"
23-3540-25
25 cm / 10"
Ferrozell handle



Hexagon
23-3545-17
17 cm / 6¾"
23-3545-25
25 cm / 10"
Ferrozell handle



Hexagon
23-3550-17
17 cm / 6¾"
23-3550-25
25 cm / 10"
Ferrozell handle



Hexagon
23-3555-17
17 cm / 6¾"
23-3555-25
25 cm / 10"
Ferrozell handle



Hexagon
23-3560-18
18 cm / 7"
1.5 mm tip
With sleeve



23-3567-00
3.5 mm

23-3568-00
4.5 mm

Lead Hand
Bleihand
Manopla de plomo



23-3570-00 For children
23-3571-00 For adults

Nail Instruments, Finger Ring Saws
Instrumente für Nägel, Fingerringsägen
Instrumentos para unas, Sierras para abrir anillos



23-3575-17
17 cm / 6 1/4"
Ring cutter



Walton
23-3580-16
16 cm / 6 1/4"
23-3581-16
Spare blade for ring cutters



23-3585-17
17 cm / 6 1/4"
Ring cutter

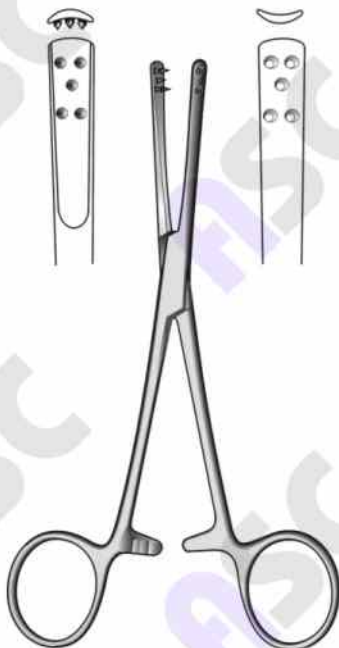

Penner
23-3590-15
15.5 cm / 6"

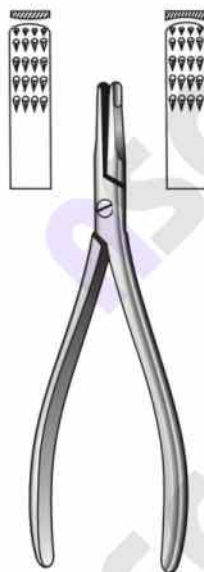

Radolf
23-3595-13
13.5 cm / 5 1/4"



23-3601-14
14.5 cm / 5 3/4"
Nail extracting forceps

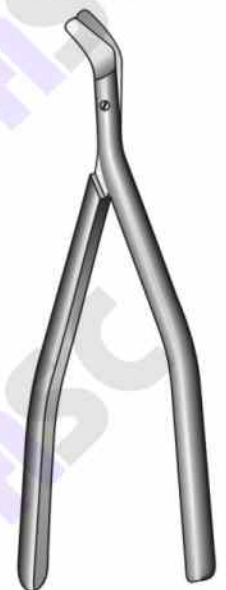

Coupe Clamp
23-3605-14
14 cm / 5 1/2"
Plastic

Bone Curettes, double ended
Scharfe Löffel
Cucharillas cortantes dobles



23-0459-00
Fig. 00/0

23-0459-01
Fig. 0/1

23-0459-12
Fig. 1/2

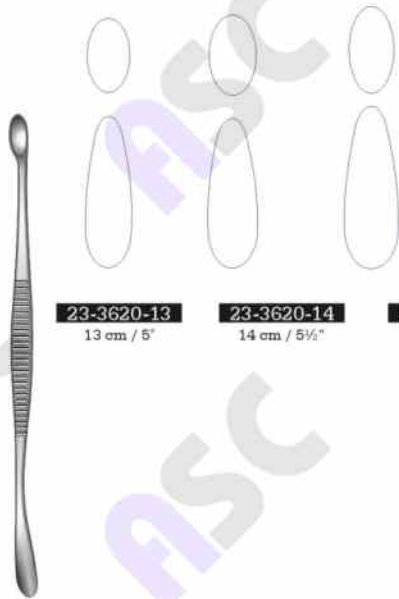
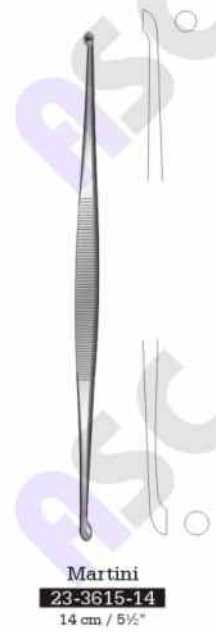

Volkman



Volkman

Bone Currettes
Scharfe Löffel
Cucharillas cortantes



Volkman
17 cm / 6 3/4"

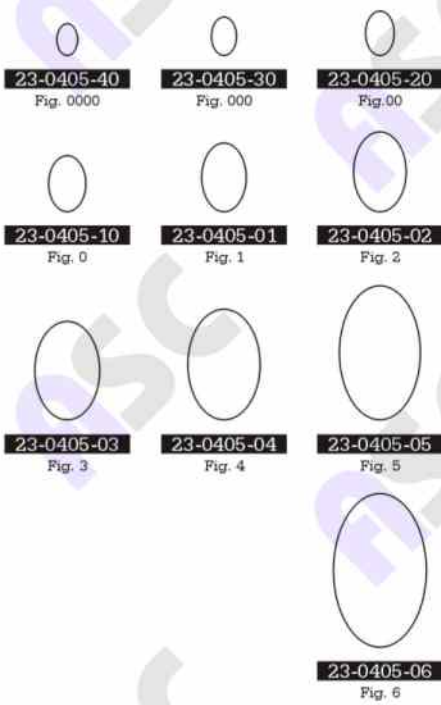

Spratt
17 cm / 6 3/4"

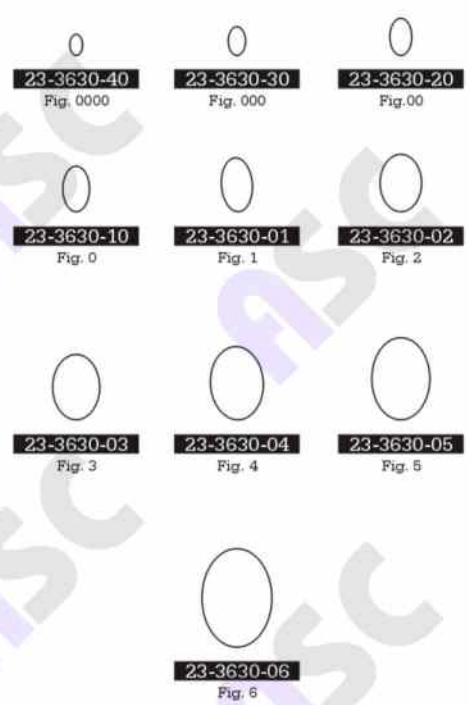

Bruns
17 cm / 6 3/4"

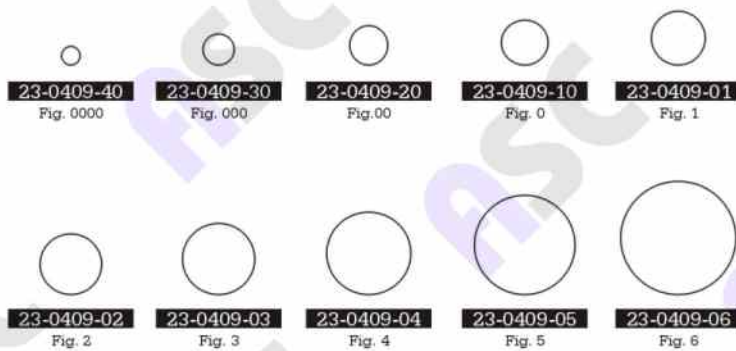



Scheide

23-3635-30
Fig. 000

23-3635-20
Fig.00

23-3635-10
Fig. 0

23-3635-01
Fig. 1

23-3635-02
Fig. 2

23-3635-03
Fig. 3

23-3635-04
Fig. 4

23-2055-00
Fig. 00

23-2056-00
Fig. 00

23-2055-01
Fig. 0

23-2056-01
Fig. 0

23-2055-02
Fig. 1

23-2056-02
Fig. 1

23-2055-03
Fig. 2

23-2056-03
Fig. 2



Williger
17,5 cm / 7"



25 cm / 9 3/4"

Bone Curettes
 Scharfe Löffel
 Cucharillas cortantes

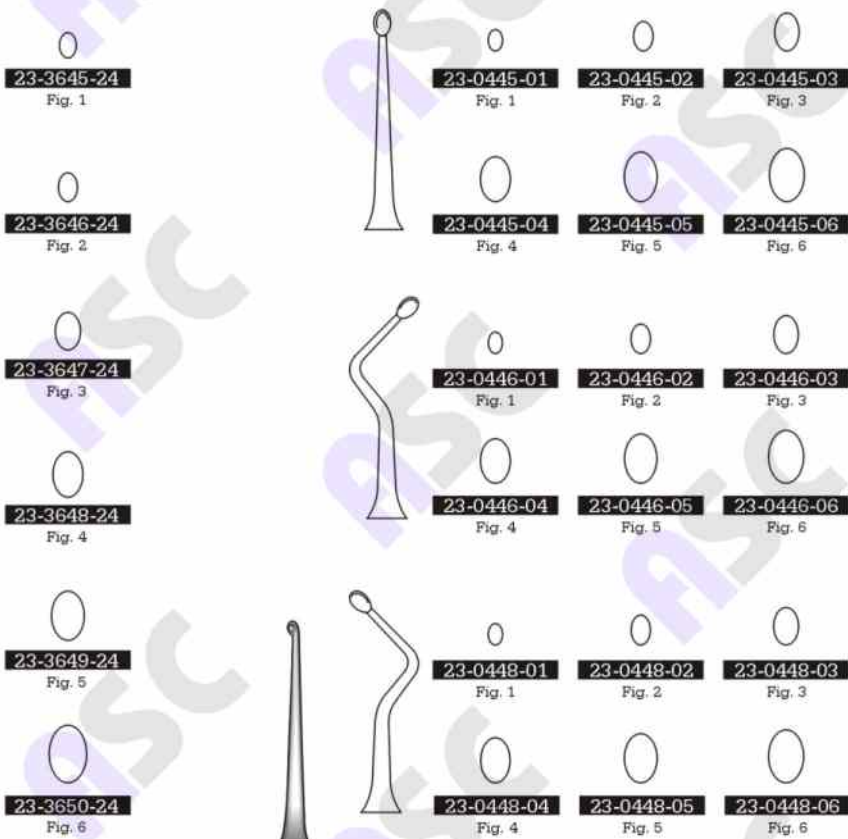

Simon
 24 cm / 9½"



Mod. USA
 16 cm / 6¼"



Halle
 21 cm / 8¼"



			
23-0381-40 Fig. 0000	23-3660-27 Fig. 0	23-3670-23 Straight 23-3680-23 Angled 45° Fig. 000	23-3690-28 Straight 23-3700-28 Angled 45° Fig. 000
23-0381-30 Fig. 000	23-3661-27 Fig. 1	23-3671-23 Straight 23-3681-23 Angled 45° Fig. 00	23-3691-28 Straight 23-3701-28 Angled 45° Fig. 00
23-0381-20 Fig. 00	23-3662-27 Fig. 2	23-3672-23 Straight 23-3682-23 Angled 45° Fig. 0	23-3692-28 Straight 23-3702-28 Angled 45° Fig. 0
23-0381-10 Fig. 0	23-3663-27 Fig. 3	23-3673-23 Straight 23-3683-23 Angled 45° Fig. 1	23-3693-28 Straight 23-3703-28 Angled 45° Fig. 1
23-0381-01 Fig. 1	23-3664-27 Fig. 4	23-3674-23 Straight 23-3684-23 Angled 45° Fig. 2	23-3694-28 Straight 23-3704-28 Angled 45° Fig. 2
23-0381-02 Fig. 2		23-3675-23 Straight 23-3685-23 Angled 45° Fig. 3	23-3695-28 Straight 23-3705-28 Angled 45° Fig. 3
23-0381-03 Fig. 3		23-3676-23 Straight 23-3686-23 Angled 45° Fig. 4	23-3696-28 Straight 23-3706-28 Angled 45° Fig. 4
23-0381-04 Fig. 4		23-3677-23 Straight 23-3687-23 Angled 45° Fig. 5	23-3697-28 Straight 23-3707-28 Angled 45° Fig. 5
23-0381-05 Fig. 5		23-3678-23 Straight 23-3688-23 Angled 45° Fig. 6	23-3698-28 Straight 23-3708-28 Angled 45° Fig. 6
23-0381-06 Fig. 6			

Bone Osteotomes Chisels, Gouges
 Meißel, Osteotome
 Cinceles, Gubias para huesos

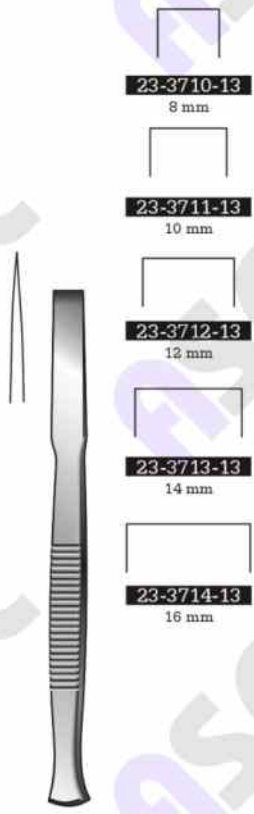

13.5 cm / 5 1/4"
 Osteotomes

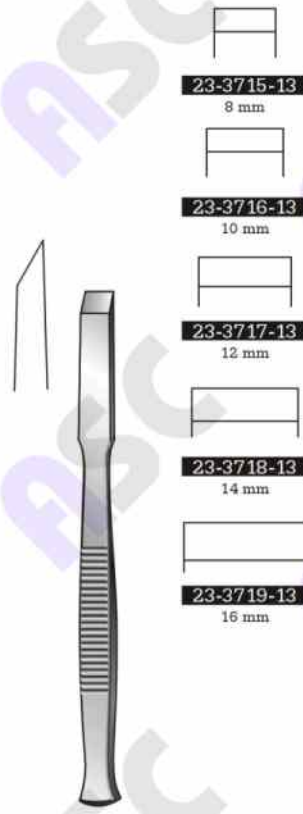

13.5 cm / 5 1/4"
 Chisels



13.5 cm / 5 1/4"
 Gouges



Gillies
 23-3725-14 6 mm
 23-3726-14 7 mm
 23-3727-14 9 mm
 14 cm / 5 1/2"
 Osteotomes

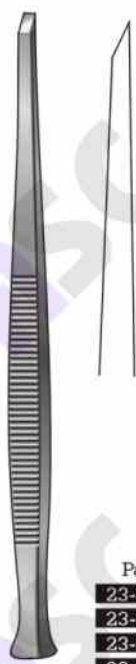

Partsch
 23-3730-17 3 mm
 23-3731-17 4 mm
 23-3732-17 5 mm
 23-3733-17 6 mm
 23-3734-17 7 mm
 17 cm / 6 3/4"
 Chisels

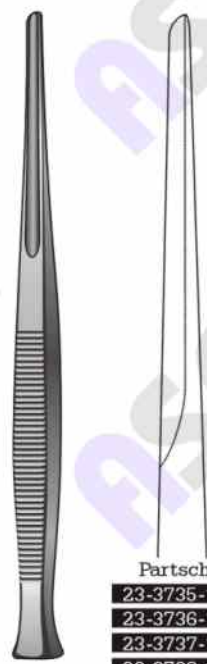

Partsch
 23-3735-17 3 mm
 23-3736-17 4 mm
 23-3737-17 5 mm
 23-3738-17 6 mm
 23-3739-17 7 mm
 17 cm / 6 3/4"
 Gouges

Bone Osteotomes Chisels, Gouges
Meißel, Osteotome
Cinceles, Gubias para huesos

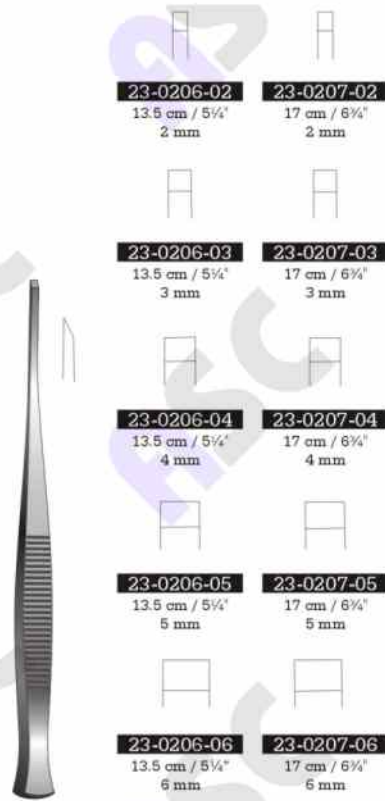

Partsch
Chisels

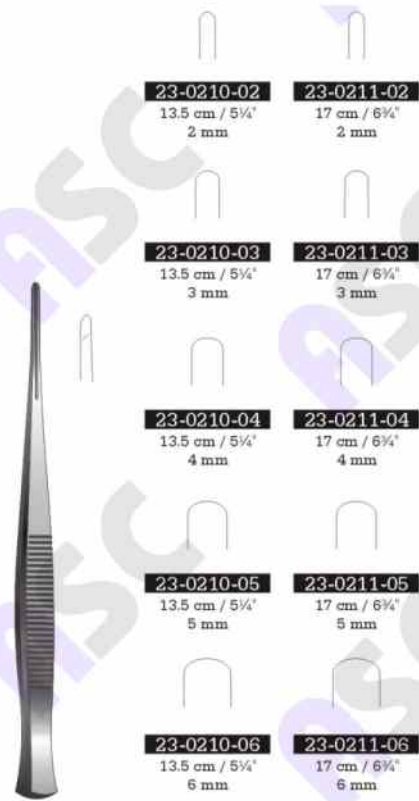

Partsch
Gouge



Alexander
18 cm / 7"
Chisels



Alexander
18 cm / 7"
Gouge



Bone Osteotomes Chisels, Gouges
 Meißel, Osteotome
 Cinceles, Gubias para huesos



Lucas
 23-3760-16 4 mm
 23-3761-16 6 mm
 16 cm / 6 1/4"



Lucas
 23-3765-16 3 mm
 23-3766-16 5 mm
 16 cm / 6 1/4"



Cottle
 23-3770-18 4 mm
 23-3771-18 6 mm
 23-3772-18 8 mm
 23-3773-18 10 mm
 23-3774-18 12 mm
 18 cm / 7"
 With depth markings



Cottle
 23-3780-18 4 mm
 23-3781-18 7 mm
 23-3782-18 9 mm
 23-3783-18 12 mm
 18 cm / 7"
 With depth markings



Cottle
 23-3785-18
 18 cm / 7"
 8 mm
 Fishtail chisel, with protected ends



East Grinstead (Ward)
 23-3790-18 3 mm
 23-3791-18 5 mm
 18 cm / 7"



Eastmann
 23-3795-19 3 mm
 23-3796-19 5 mm
 19 cm / 7 1/2"



East Grinstead (Ward)
 23-3800-18 3 mm
 23-3801-18 5 mm
 18 cm / 7"

Bone Osteotomes Chisels, Gouges
Meißel, Osteotome
Cinceles, Gubias para huesos

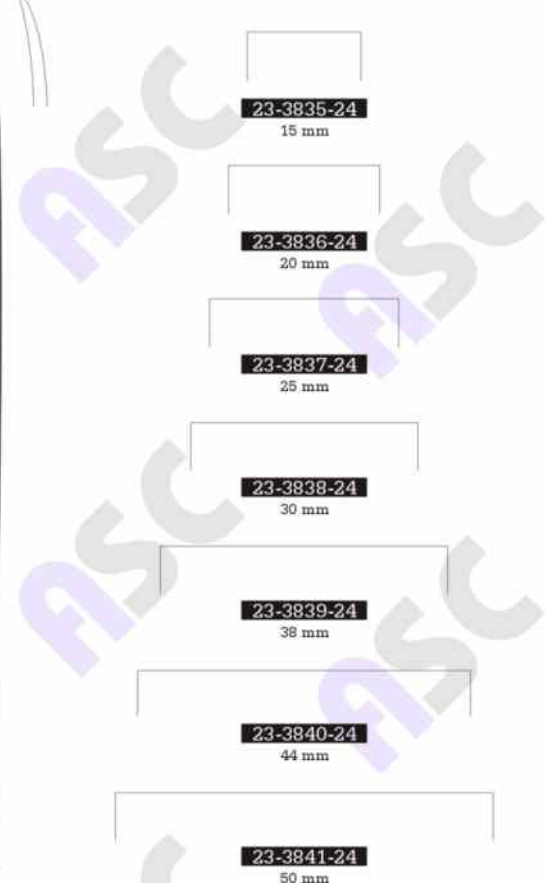
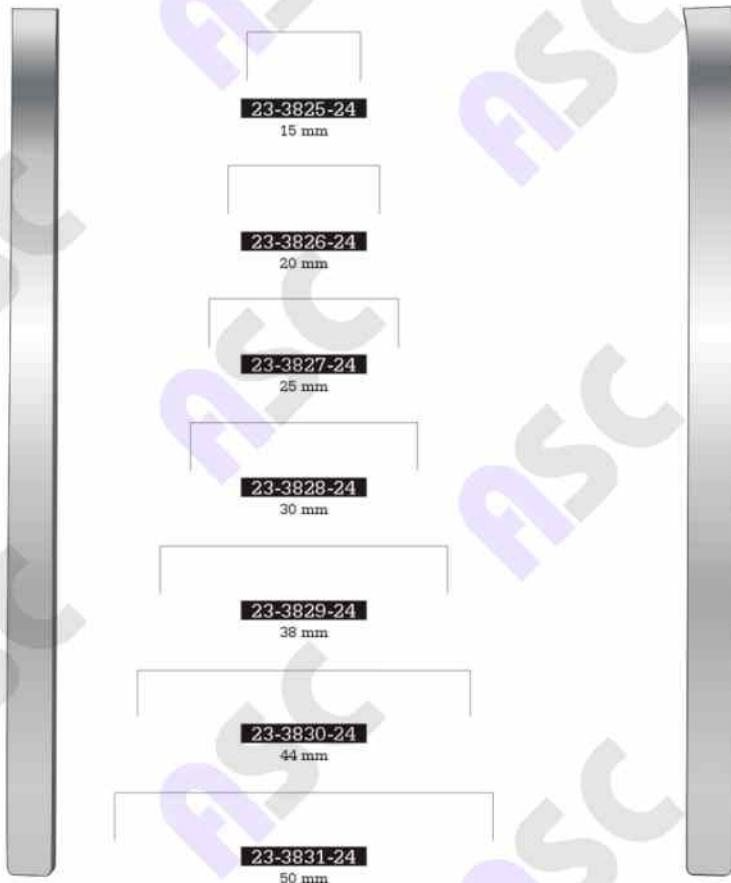
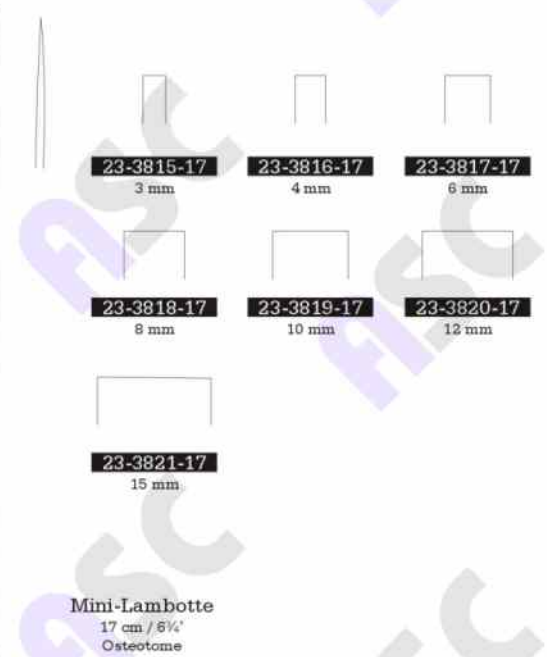
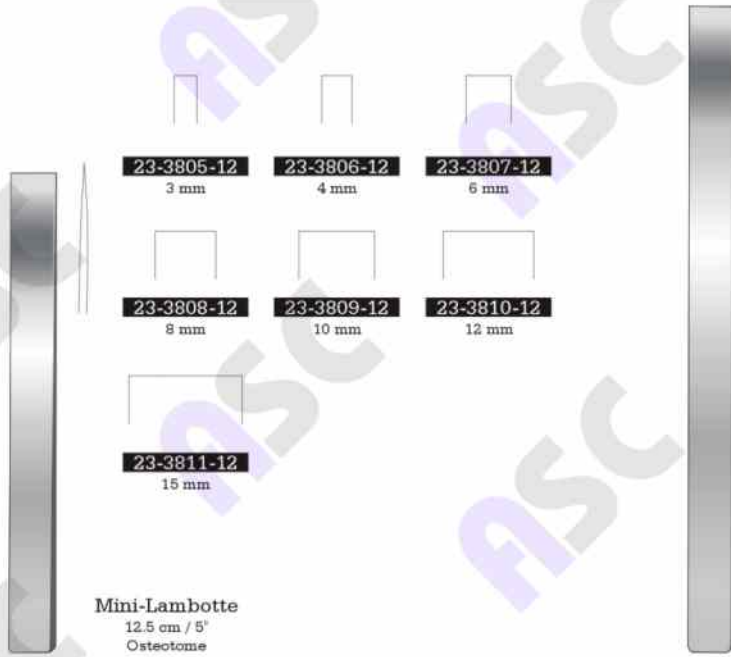

Bone Osteotomes Chisels, Gouges
 Meißel, Osteotome
 Cinceles, Gubias para huesos



Key

- 23-3865-19** 19 cm / 7½"
- 23-3865-21** 21 cm / 8¼"

Periosteal elevator



Stille

- 23-3870-20** 10 mm
- 23-3871-20** 12 mm
- 23-3872-20** 15 mm
- 23-3873-20** 20 mm
- 23-3874-20** 25 mm

20.5 cm / 8"
Chisels



Stille

- 23-3880-20** 10 mm
- 23-3881-20** 12 mm
- 23-3882-20** 15 mm
- 23-3883-20** 20 mm
- 23-3884-20** 25 mm

20.5 cm / 8"
Gouges



Stille

- 23-3890-20** 10 mm
- 23-3891-20** 12 mm
- 23-3892-20** 15 mm
- 23-3893-20** 20 mm
- 23-3894-20** 25 mm

20.5 cm / 8"
Gouges



Stille

- 23-3900-20** 8 mm
- 23-3901-20** 10 mm
- 23-3902-20** 12 mm
- 23-3903-20** 15 mm
- 23-3904-20** 20 mm
- 23-3905-20** 25 mm

20.5 cm / 8"
Osteotomes



Stille

- 23-3910-20** 10 mm
- 23-3911-20** 12 mm
- 23-3912-20** 15 mm
- 23-3913-20** 20 mm
- 23-3914-20** 25 mm

20.5 cm / 8"
Osteotomes, straight



Stille

- 23-3920-20** 10 mm
- 23-3921-20** 12 mm
- 23-3922-20** 15 mm
- 23-3923-20** 20 mm
- 23-3924-20** 25 mm

20.5 cm / 8"
Osteotomes, curved

Bone Osteotomes Chisels, Gouges
Meißel, Osteotome
Cinceles, Gubias para huesos

23-3930-20

23-3940-20
6 mm

23-3931-20
9 mm

23-3941-20
9 mm

23-3932-20
13 mm

23-3942-20
13 mm

23-3933-20
16 mm

23-3943-20
16 mm

23-3950-20
9 mm

23-3955-20
9 mm

23-3934-20
19 mm

23-3944-20
19 mm

23-3951-20
14 mm

23-3956-20
14 mm

23-3935-20
25 mm

23-3945-20
25 mm

23-3952-20
19 mm

23-3957-20
19 mm

23-3936-20
32 mm

23-3946-20
32 mm

23-3953-20
25 mm

23-3958-20
25 mm

Smith Peterson
20 cm / 8"

Smith Peterson
20 cm / 8"

Smith Peterson
20 cm / 8"

Smith Peterson
20 cm / 8"

Bone Osteotomes Chisels, Gouges
 Meißel, Osteotome
 Cinceles, Gubias para huesos

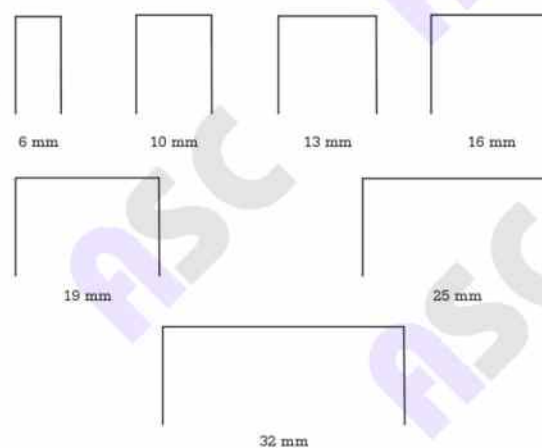
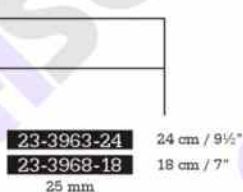
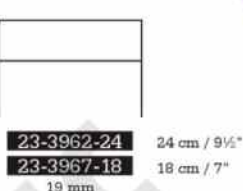
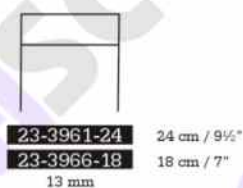
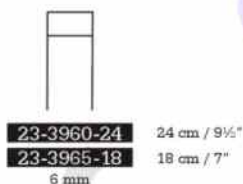

23-3970-24	6 mm	23-3990-24
23-3971-24	10 mm	23-3991-24
23-3972-24	13 mm	23-3992-24
23-3973-24	16 mm	23-3993-24
23-3974-24	19 mm	23-3994-24
23-3975-24	25 mm	23-3995-24
23-3976-24	32 mm	23-3996-24
24 cm / 9 1/2"		24 cm / 9 1/2"
Straight		Curved
23-3980-18	6 mm	23-4001-18
23-3981-18	10 mm	23-4002-18
23-3982-18	13 mm	23-4003-18
23-3983-18	16 mm	23-4004-18
23-3984-18	19 mm	23-4005-18
23-3985-18	25 mm	23-4006-18
23-3986-18	32 mm	23-4007-18
18 cm / 7"		18 cm / 7"
Straight		Curved



Hibbs / Hilder
 Chisel



Hibbs / Hilder
 Osteotome

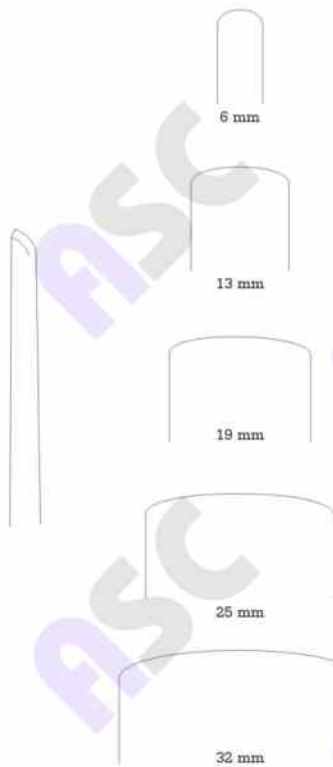

23-4010-18	6 mm	23-4010-23
23-4011-18	13 mm	23-4011-23
23-4012-18	19 mm	23-4012-23
23-4013-18	25 mm	23-4013-23
23-4014-18	32 mm	23-4014-23
18 cm / 7"		23 cm / 9"
Straight		Straight

Hilder
Gouge

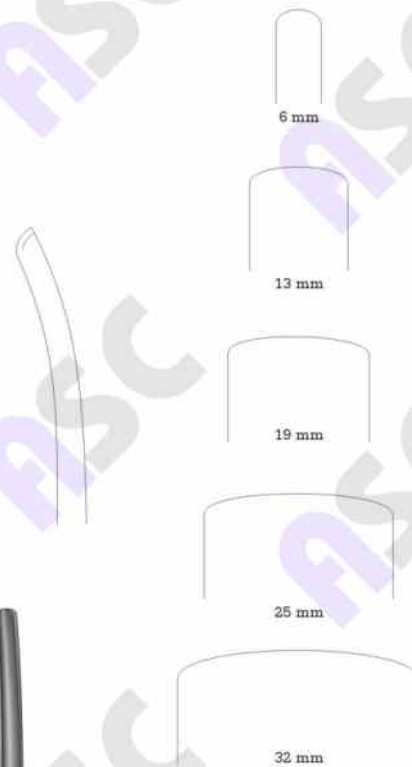

23-4020-18	6 mm	23-4020-23
23-4021-18	13 mm	23-4021-23
23-4022-18	19 mm	23-4022-23
23-4023-18	25 mm	23-4023-23
23-4024-18	32 mm	23-4024-23
18 cm / 7"		23 cm / 9"
Curved		Curved

Hilder
Gouge

Chisels
Flachmeißel
Cinceles



Farabeuf
21 cm / 8 1/4"
Osteotome

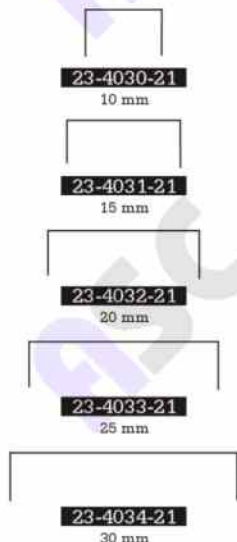

Farabeuf
25 cm / 10"
Chisel



Hautant
13 cm / 5"
Chisel

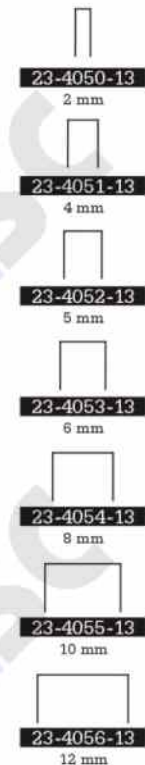

Judet
22 cm / 8 1/4"
Chisel



Letourne
35 cm / 14"
Gouge





23-4075-21
35 mm

Laucas Championniere
21 cm / 8¼"



23-4080-20
10 mm

23-4081-20
15 mm

23-4082-20
20 mm

Maceven
20 cm / 8"



23-4085-13
3.5 mm

Mante
13 cm / 5"



23-4090-14
10 mm

23-4091-14
15 mm

23-4092-14
20 mm

Ombredanne
14 cm / 5½"



23-4100-00 14 cm
23-4105-00 17 cm

2 mm

23-4101-00 14 cm
23-4106-00 17 cm

3 mm

23-4102-00 14 cm
23-4107-00 17 cm

4 mm

23-4103-00 14 cm
23-4108-00 17 cm

6 mm

23-4104-00 14 cm
23-4109-00 17 cm

8 mm

Partsch



23-4115-16
4 mm

23-4116-16
6 mm

23-4117-16
8 mm

23-4118-16
10 mm

23-4119-16
12 mm

23-4120-16
14 mm

Poirier
16 cm / 6¼"



23-4125-16
6 mm

23-4126-16
8 mm

23-4127-16
10 mm

23-4128-16
12 mm

Portmann
16 cm / 6¼"

Gouges
Hohlmeißel
Gubias



- 23-4130-30
Straight
- 23-4131-30
Half curved
- 23-4132-30
Curved



- 23-4135-28
8 mm
- 23-4136-16
10 mm
- 23-4137-16
12 mm

Cobb
30 cm / 11 1/2"
Blade 6 mm

Cobb
28 cm / 11"



- 23-4140-24
2 mm
- 23-4141-24
4 mm
- 23-4142-24
6 mm
- 23-4143-24
8 mm

Guillaume
24 cm / 9 1/2"



- 23-4145-13
2 mm
- 23-4146-13
4 mm
- 23-4147-13
5 mm
- 23-4148-13
6 mm
- 23-4149-13
8 mm
- 23-4150-13
10 mm
- 23-4151-13
12 mm

Hautant
13 cm / 5"



- 23-4155-29
Straight
- 23-4156-29
Concave
- 23-4157-29
29.5 cm / 11 1/2"

Horton
29.5 cm / 5"



Poirier-Trillat
20 cm / 8"

23-4160-20

4 mm

23-4161-20

6 mm

23-4162-20

8 mm

23-4163-20

10 mm

23-4164-20

12 mm

23-4165-20

14 mm



Poirier
16 cm / 6 1/4"

23-4170-16

2 mm

23-4171-16

4 mm

23-4172-16

6 mm

23-4173-16

8 mm

23-4174-16

10 mm

23-4175-16

12 mm

23-4176-16

14 mm



Postel
25 cm / 10"

23-4180-25

Straight

23-4181-25

Angled 135°

23-4182-25

Angled 150°

8 mm



Putti
25 cm / 10"

23-4185-25

30 mm

Osteotomes, Gouges
Meißel, Osteotome
Osteotomos, Gubias

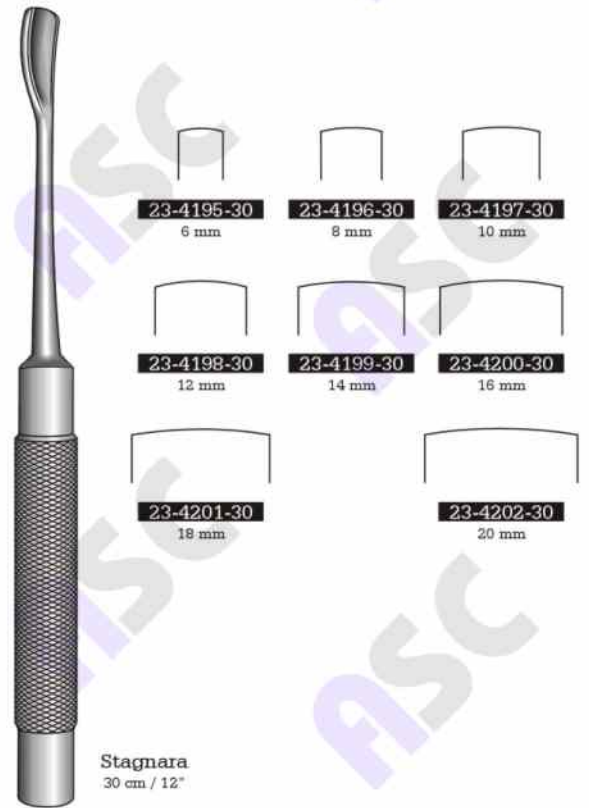
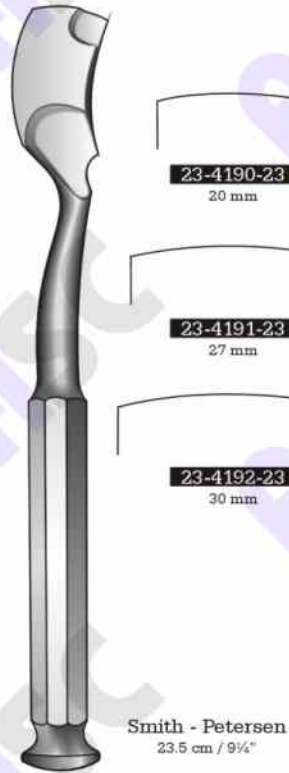

Cauchoix
25 cm / 10"

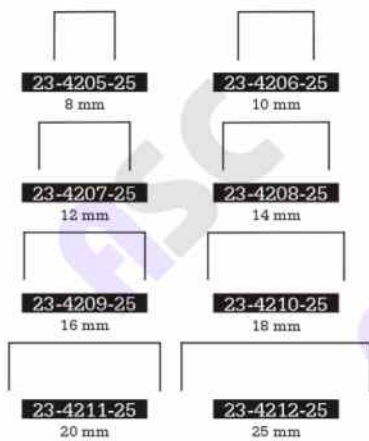

Farabeuf
21 cm / 8 1/4"



Robin
16 cm / 6 1/4"

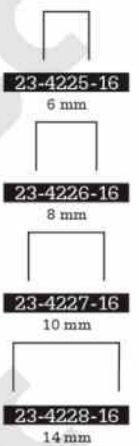

Bone Chisels, Gouges
Meißel, Osteotome
Cinceles, Gubias para huesos



Lebsche
23-4230-24
24.5 cm / 9 1/4"



Virchow
23-4235-00
Skull breaker



23-4240-22
22 cm / 8 3/4"



Brunetti
23-4245-28
28 cm / 11"
Left



Brunetti
23-4250-28
28 cm / 11"
Right



Cobb
23-4255-29 Tip 10 mm
23-4256-29 Tip 13 mm
23-4257-29 Tip 19 mm
29 cm / 11 1/2"
Spinal elevator

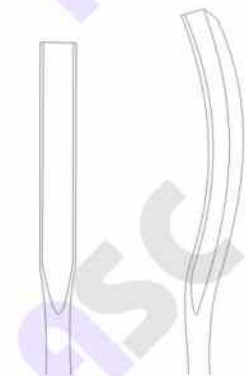

23-4261-28 Straight
23-4262-28 Medium curve



23-4263-28 Strong curve
23-4264-28 Reverse curve

Cobb
23-4260-28
28 cm / 11"
Spinal gouge
7 mm blade width

Bone Osteotomes Chisels, Gouges
Osteotome, Hohlmeißel
Cinceles, Gubias para huesos



Mini-Lexer
18 cm / 7"
Ferrozell handle

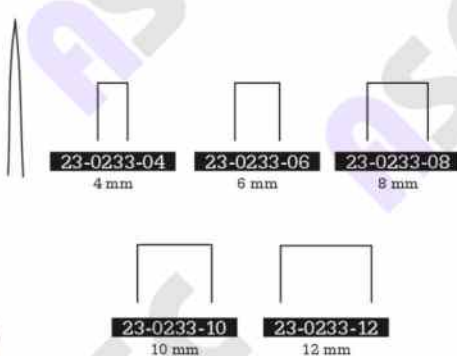

Mini-Lexer
18 cm / 7"
Ferrozell handle



Lexer
22 cm / 8 3/4"
Ferrozell handle

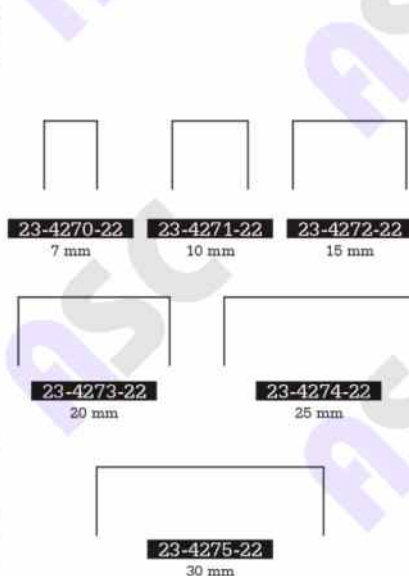

Lexer
22 cm / 8 3/4"
Ferrozell handle

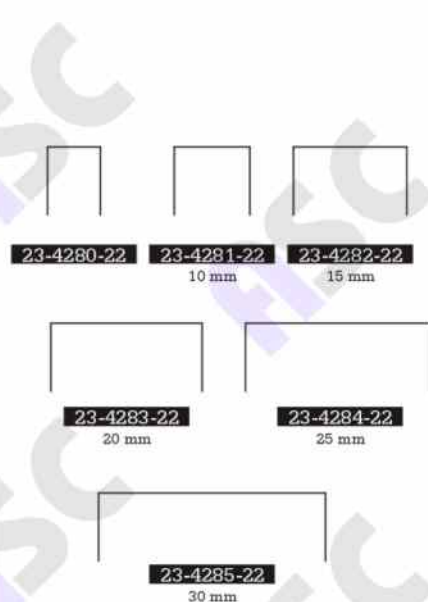



Lexer
25 cm / 10"
Ferrozell handle



23-4300-25
5 mm



23-4301-25
10 mm



23-4302-25
15 mm



Lexer
25 cm / 10"
Ferrozell handle



23-4305-25
5 mm



23-4306-25
10 mm



23-4307-25
15 mm

Bone Osteotome Chisels, Gouges
Meißel, Osteotome
Cinceles, Gubias para huesos



23-4310-24
24.5 cm / 9 1/2"
20 mm
Ferrozell handle

23-4315-26
26.5 cm / 10 1/2"
16 mm
Ferrozell handle, curved

Lexer
23-4320-27 10 mm
23-4321-27 15 mm
27.5 cm / 10 3/4"
Ferrozell handle

Lexer
23-4325-27 10 mm
23-4326-27 15 mm
27.5 cm / 10 3/4"
Ferrozell handle



23-4330-25 5 mm
23-4331-25 10 mm
23-4332-25 15 mm
25 cm / 10"
Ferrozell handle
Spongiosa gouge



Lamina
23-4335-23 6 mm
23-4336-23 8 mm
23-4337-23 11 mm
23-4338-23 16 mm
23.5 cm / 9 1/4"
Ferrozell handle



23-4340-25 5 mm
23-4341-25 10 mm
23-4342-25 15 mm
25 cm / 10"
Curved
Ferrozell handle
Spongiosa gouge

Gouges
Hohlmeißel
Gubias

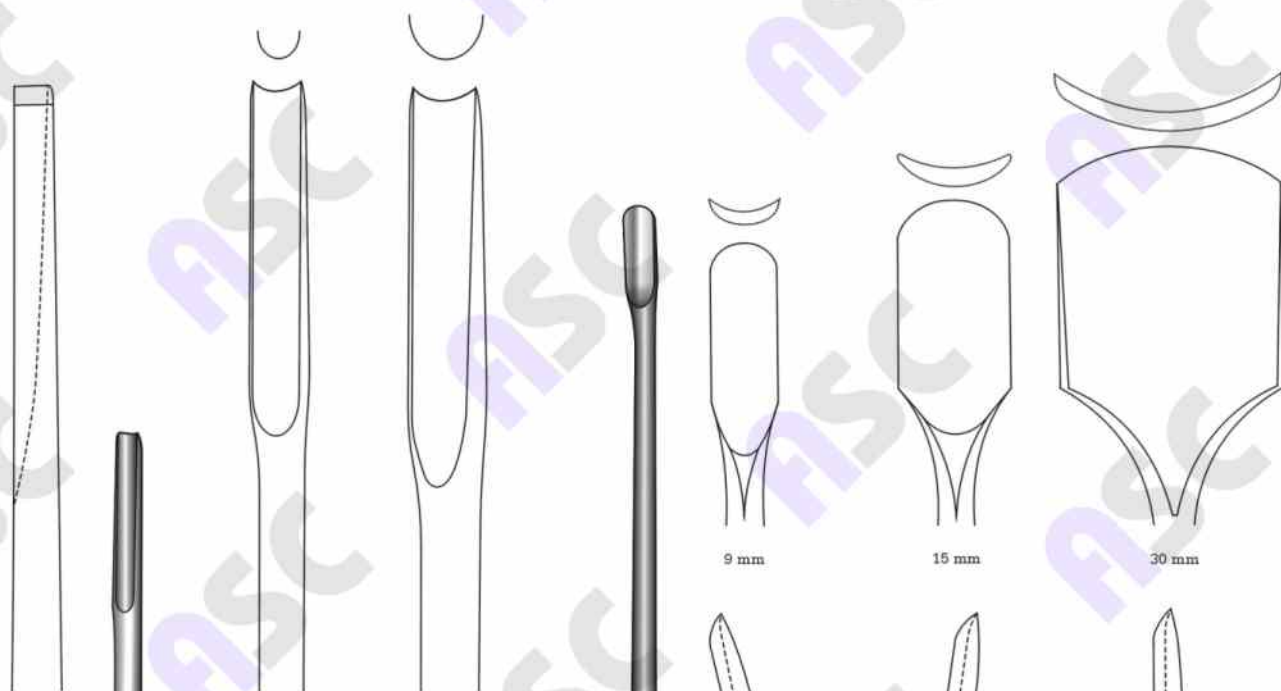

23-4345-28

23-4346-28

9 mm

15 mm

30 mm

23-4350-34	9 mm	23-4355-34	9 mm	23-4360-34	9 mm
23-4351-34	15 mm	23-4356-34	15 mm	23-4361-34	15 mm
23-4352-34	30 mm	23-4357-34	30 mm	23-4362-34	30 mm
Inclined forward		Inclined backward		Straight	



Lexer
28 cm / 11"
Ferozell handle
Spongiosa gouge



Wagner
34 cm / 13½"
Ferozell handle

Chisel Blades, Chisel Handles
Meißelklingen, Meißelgriffe
Hojas de cincel, Mangos para hojas de cincel



23-4365-18
18.5 cm / 7 1/4"
Handle, only
Ferozell handle



5 mm
23-4366-08
8.5 cm / 3 1/4"



10 mm
23-4367-08
8.5 cm / 3 1/4"



16 mm
23-4368-08
8.5 cm / 3 1/4"



25 mm
23-4369-08
8.5 cm / 3 1/4"

Osteotome blades,
interchangeable



5 mm
23-4370-08
8.5 cm / 3 1/4"



10 mm
23-4371-08
8.5 cm / 3 1/4"



16 mm
23-4372-08
8.5 cm / 3 1/4"



25 mm
23-4373-08
8.5 cm / 3 1/4"

Chisel blades,
interchangeable

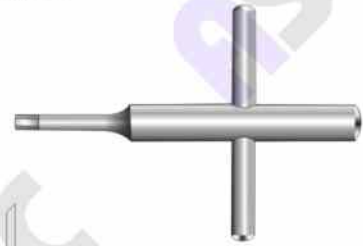

23-4375-09
9 cm / 3 1/2"
Key
23-4376-00
Spare screw



Gouge blades,
interchangeable

Radius 50 mm

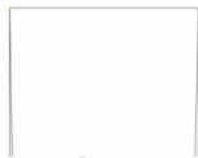

25 mm
23-4380-13
13.5 cm / 5 1/4"

Radius 60 mm



25 mm
23-4381-13
13.5 cm / 5 1/4"

Radius 70 mm



25 mm
23-4382-13
13.5 cm / 5 1/4"

Bone Hooks
Knochenhaken
Ganchos para huesos

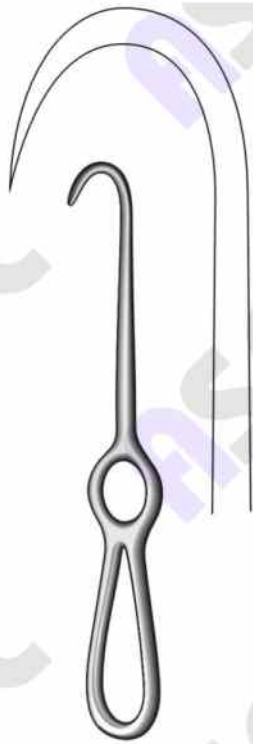

Volkmann
23-4385-20
20 cm / 8"
19 x 27 mm
Sharp

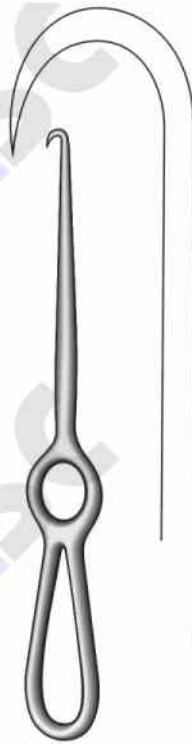

Volkmann
23-4390-23
23 cm / 9"
15 x 20 mm
Sharp



Volkmann
23-4395-25
25 cm / 9 3/4"
15 x 20 mm
Sharp



23 cm / 9"
Sharp
Bone hook with grip handle



23-4400-23
6 x 10 mm
Small



23-4401-23
11 x 18 mm
Medium



23-4402-23
12 x 30 mm
Large

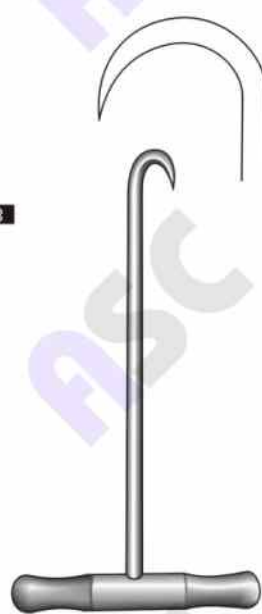

23-4405-18
18 cm / 7"
18 x 21 mm
Sharp with T-handle
large, for femurs



Zygoma
23-4410-17
17 cm / 6 1/2"

Elevators
Elevatoriën
Elevadores



Williger

- 23-4415-16** Tip 4 mm
 - 23-4416-16** Tip 5 mm
 - 23-4417-16** Tip 6 mm
 - 23-4418-16** Tip 7 mm
- 16 cm / 6 1/4"



Langenbeck
20 cm / 8"

23-4420-20
Tip 8 mm



23-4421-20
Tip 10 mm



23-4445-17
17 cm / 6 3/4"



8 mm



Langenbeck

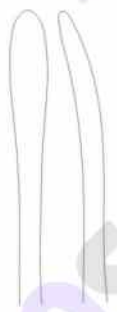

23-4450-17
17 cm / 6 3/4"
5 mm



23-4451-17
17 cm / 6 3/4"
7 mm



23-4450-20
20 cm / 8"
8 mm



23-4451-20
20 cm / 8"
10 mm



23-4455-17



23-4456-17



23-4457-17



23-4458-17



Adson
17 cm / 6 3/4"

Periosteal Elevators
Raspatorien
Legras, Periostotomos

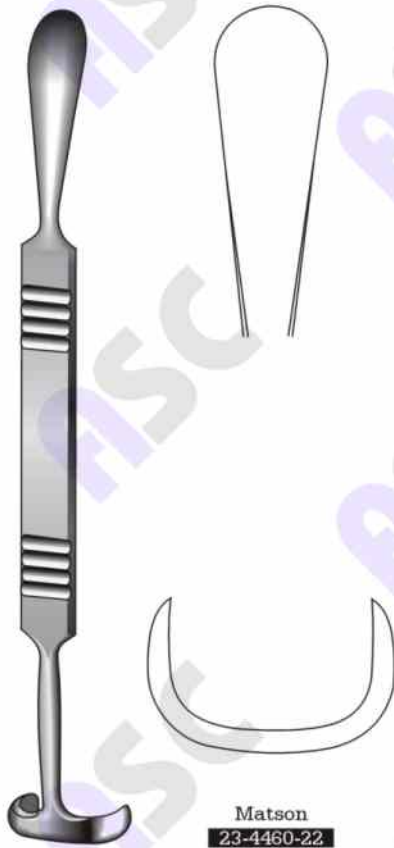

Matson
23-4460-22
22 cm / 8 3/4"

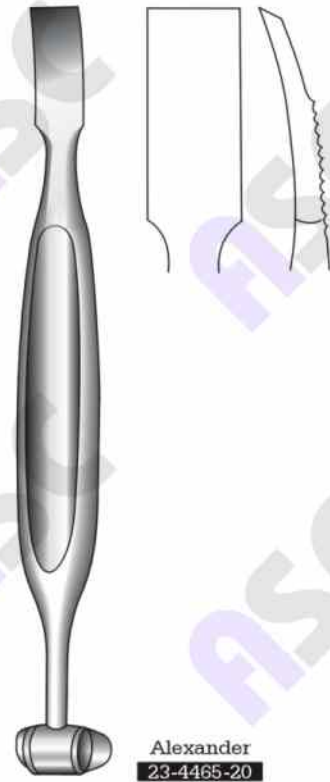

Alexander
23-4465-20
20 cm / 8"



Semb



23-4470-17
17,5 cm / 7"



23-4471-21
21 cm / 8 1/4"



23-4472-17
17,5 cm / 7"



23-4473-21
21 cm / 8 1/4"



23-4474-20
20,5 cm / 8"



Doyen
17 cm / 6 1/2"



Williger
23-4485-13
13 cm / 5"
5 mm

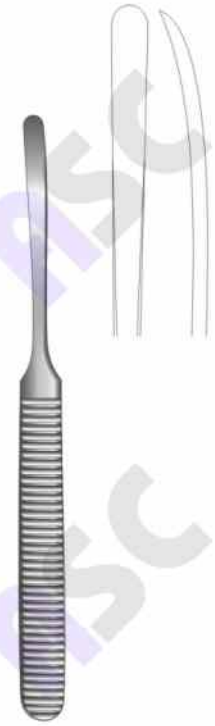

Williger
23-4490-16 4 mm
23-4491-16 5 mm
23-4492-16 6 mm
23-4493-16 7 mm
15 cm / 6 1/4"

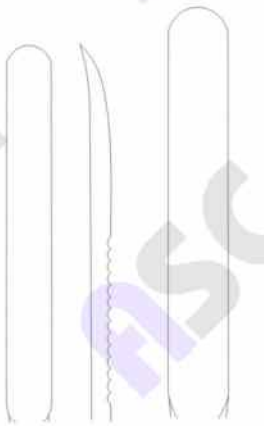

17 cm / 6 1/2"



Lambotte
21 cm / 8 1/4"



Konig
23-4505-15
15.5 cm / 6"

Periosteal Elevators
Raspatorien
Periostotomos, Legras

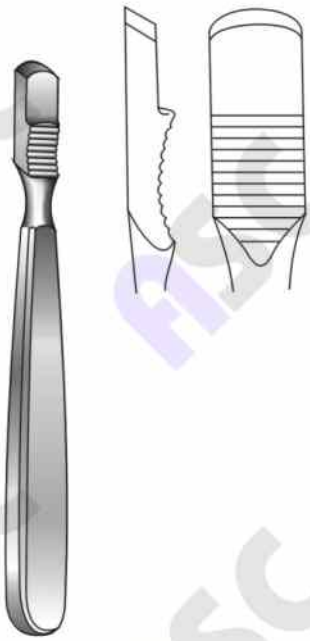

Parabeuf
23-4510-15
15 cm / 6"
Straight



Parabeuf
23-4515-15
15 cm / 6"
Curved

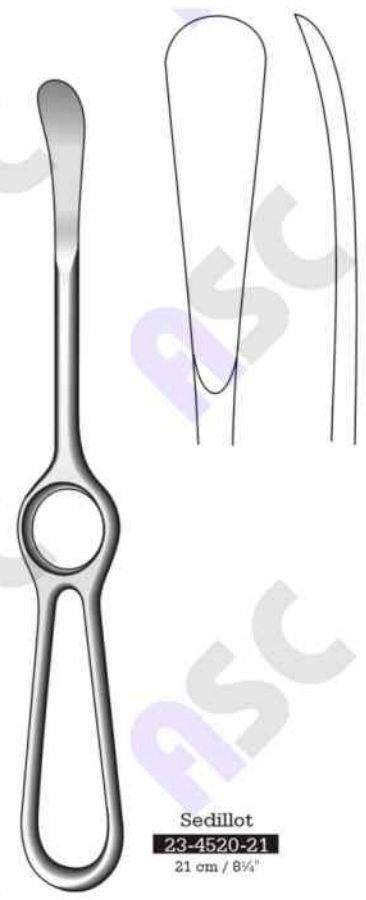

Sedillot
23-4520-21
21 cm / 8 1/4"



16 cm / 6 1/4"
Delicate, Solid

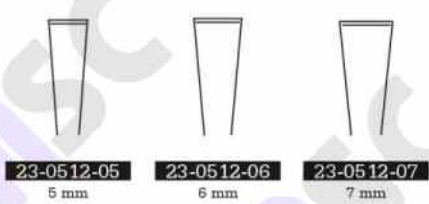

23-0512-05
5 mm

23-0512-06
6 mm

23-0512-07
7 mm



Langenbeck
23-4525-18
18 cm / 7"



Cushing
23-4530-17
17 cm / 6½"



Cushing



Langenbeck



Hoen



Periosteal Elevators
Raspatorien
Periostotomos, Legras



23-4550-18
18 cm / 7"
Ferozell handle



23-4555-18
18 cm / 7"
Ferozell handle



23-4560-18
18 cm / 7"
Ferozell handle



23-4565-20
20 cm / 8"
Ferozell handle



23-4570-20
20 cm / 8"
Ferozell handle



23-4575-20
20 cm / 8"
Ferozell handle



23-4580-00
16 mm



23-4585-14
14 cm / 5 1/2"



23-4590-15
15 cm / 6"
5 mm



23-4595-15
15 cm / 6"
7 mm



Buck-Gramcko
23-4601-15
15 cm / 6"



7.5 mm



23-4605-00
15 mm



Mini-Hohmann
16 cm / 6 1/2"



23-4610-16
6 mm



23-4611-16
8 mm



Freer
23-4615-18
18.5 cm / 7 1/4"
Sharp/Blunt

Bone Levers
Knochenhebel
Elevadores para huesos



Hohmann
23-4620-00
22 cm / 8 3/4"
8 mm

Hohmann
23-4625-00
23.5 cm / 9 1/4"
18 mm

Hohmann
23-4630-00
23.5 cm / 9 1/4"
43 mm

Hohmann
23-4635-00
23.5 cm / 9 1/4"
70 mm



Hohmann
23-4640-00
23.5 cm / 9¼"
43 mm

Hohmann
23-4645-00
25.5 cm / 10"
22 mm

Hohmann
23-4650-00
29 cm / 11"
33 mm

Hohmann
23-4655-00
27.5 cm / 10¾"
24 mm

Lange-Hohmann
23-4660-00
25.5 cm / 10"
22 mm

Bone Levers, Retractors
Knochenhebel, Wundhaken
Elevadores para huesos, Separadores

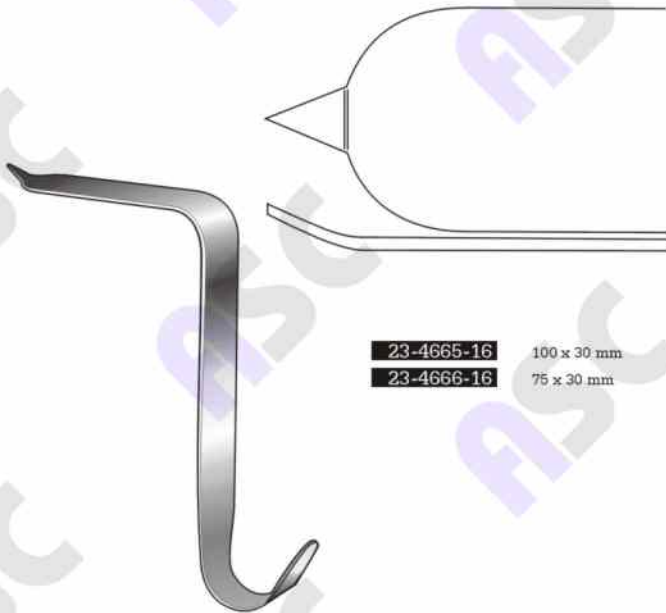

23-4665-16 100 x 30 mm
23-4666-16 75 x 30 mm

Taylor
16.5 cm / 6½"

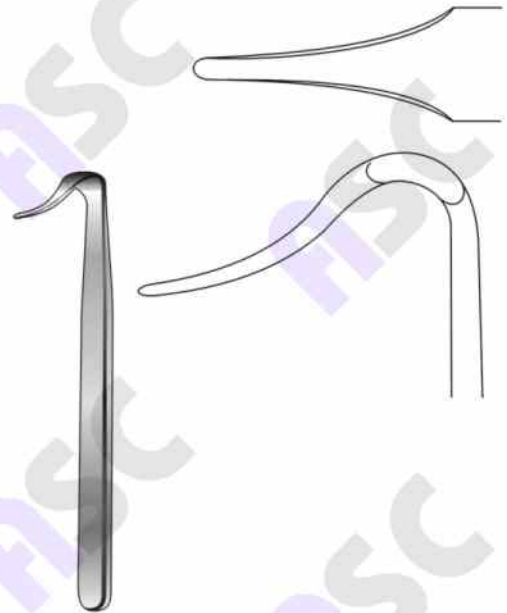

Blount
23-4670-17
17.5 cm / 7"



Bennett
23-4675-24 Small
23-4676-24 Large
24 cm / 9½"



Blount
23-4680-26
26 cm / 10¼"



Blount
23-4685-26
26 cm / 10¼"
Blunt



Smillie
23-4690-17
17 cm / 6 3/4"



Straight



23-4691-17
Curved left



23-4692-17
Curved right



23-4695-17



23-4696-17



Bircher
19 cm / 7 1/2"



23-4701-19



23-4702-19



Salenius
23-4705-22
22 cm / 8 3/4"



Salenius
23-4710-22
22 cm / 8 3/4"

Meniscotomy Knives
Meniskotome
Bisturies para meniscos

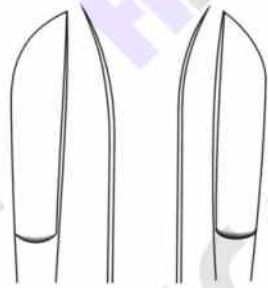

23-4715-22

23-4716-22



Neff
22 cm / 8 3/4"



23-4720-18
18 cm / 7"

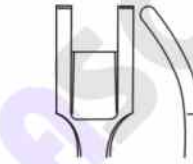

Lowe-Breck
23-4725-25
25 cm / 10"

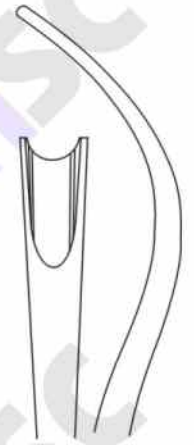

Downing
23-4730-25
25 cm / 10"

Tendon Seizing Instruments
Sehnenfaßinstrumente
Instrumentos para coger tendones



20 cm / 8"

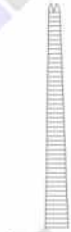

23-4735-20



23-4736-20

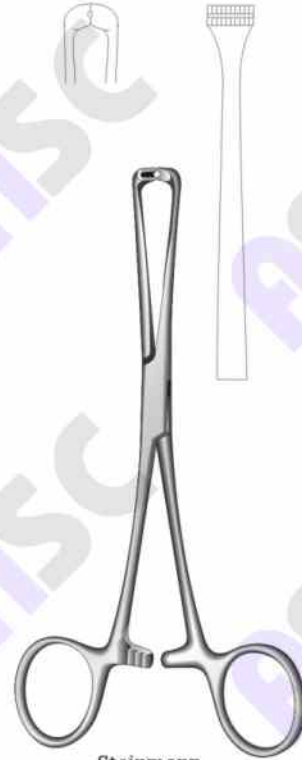

Steinmann
23-4740-16
16 cm / 6 1/4"



Brand



23-4745-15
15 cm / 6"



23-4745-19
19 cm / 7 1/2"



23-4745-24
24 cm / 9 1/2"



23-4750-10
1.5 mm



23-4751-10
2.5 mm



23-4752-10
4.5 mm



23-4753-10
5.5 mm



10 cm / 4"

Bone Holding and Reduction Forceps
Knochenhaltezangen
Pinzas para huesos



9.5 cm / 3 3/4"
Reposition forceps
with stepped tips



23-4760-13
13.5 cm / 5 1/2"

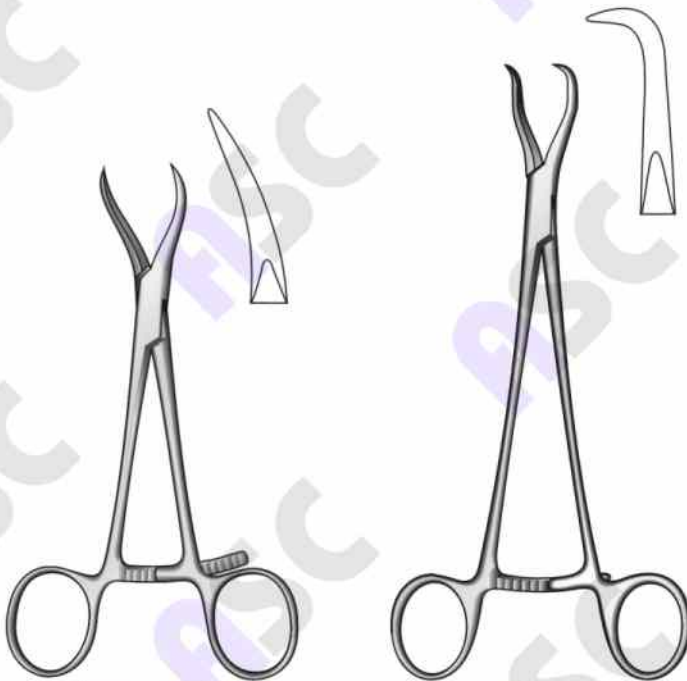

23-4765-13
13.5 cm / 5 1/4"
Reposition forceps,
especially for maxillary reposition

Haase
23-4770-16
16.5 cm / 6 1/2"
Reposition forceps
for mandibular fractures

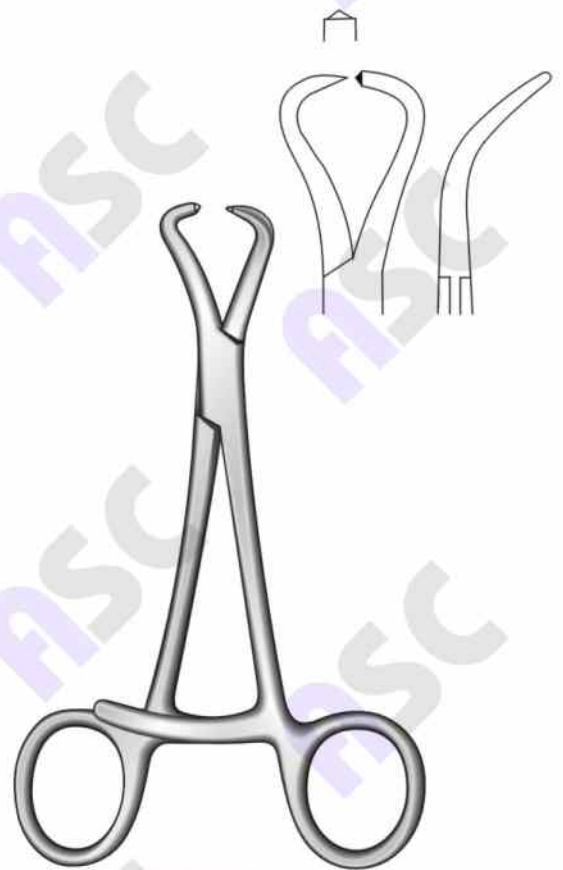

23-4775-14 14 cm / 5 1/2"
23-4775-16 16.5 cm / 6 1/2"
Curved
Bone reduction forceps

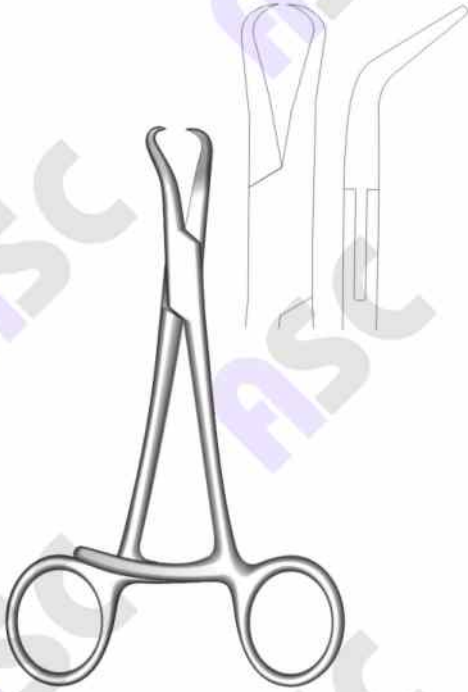

Stagbeetle
23-4780-12
12 cm / 4 1/4"
Bone reduction forceps
Curved, pointed tips



23-4785-13
13 cm / 5 1/4"
Bone holding forceps
Curved, with 1.6 mm k-wire guide



23-4790-00
Bone holding forceps

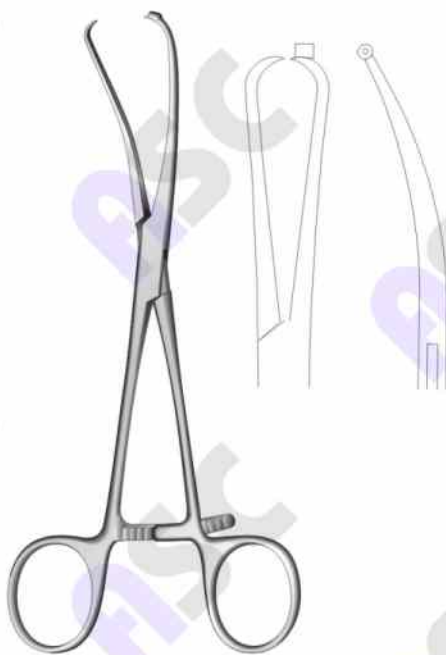

23-4795-17
17 cm / 6 3/4"
Bone holding forceps
Curved, with 1.1 mm k-wire guide

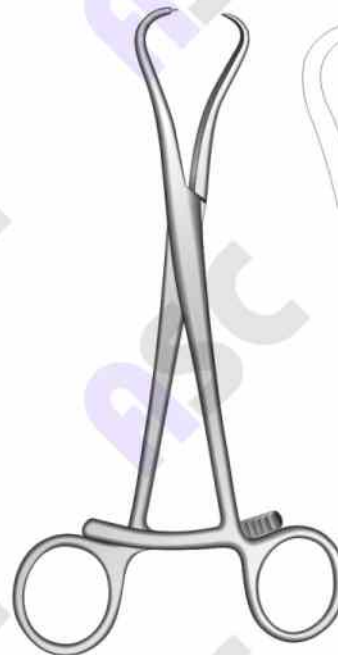

23-4800-15 15 cm / 6"
23-4800-17 17.5 cm / 7"
23-4800-20 20 cm / 8"

Bone Holding and Reduction Forceps
 Knochenhaltezangen
 Pinzas para huesos

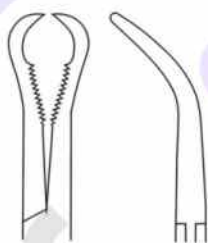
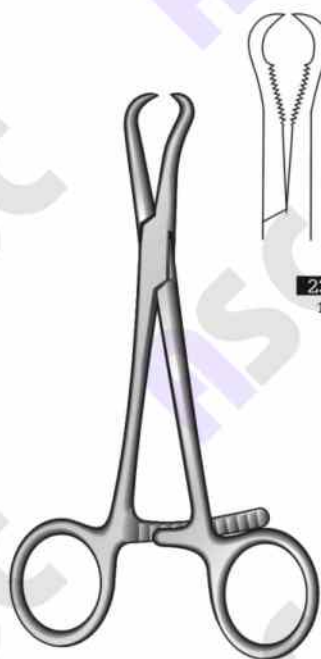

23-4805-12
 12.5 cm / 5"

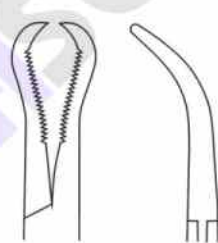

23-4805-14
 14 cm / 5½"

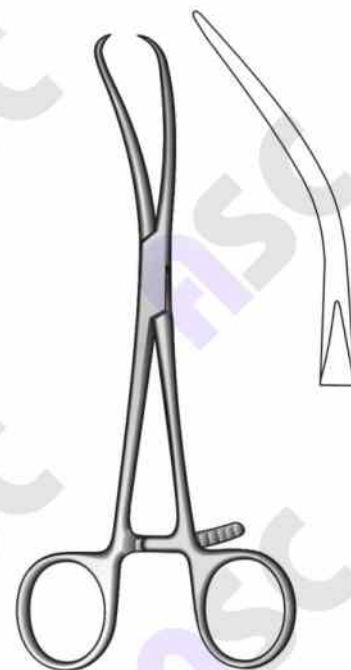

Reill
23-4810-17
 17.5 cm / 7"
 Bone reposition forceps
 curved, pointed tips



Steinhauser
23-4815-13
 13 cm / 5"

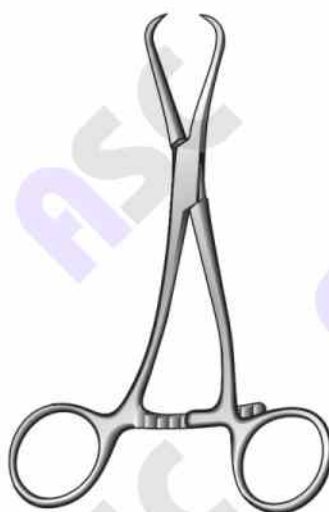

Steinhauser
23-4820-13
 13 cm / 5"

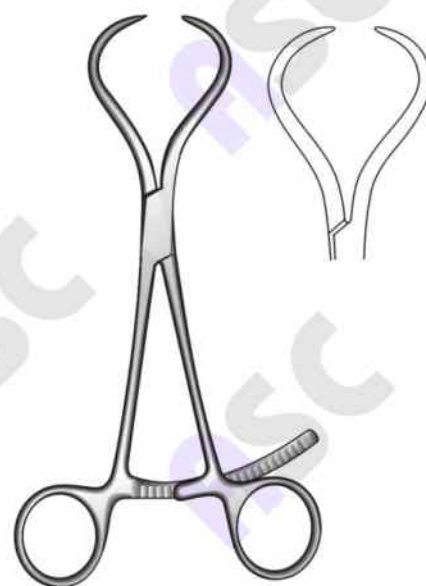

23-4825-16
 16 cm / 6¼"
 Bone fragment forceps

Bone Holding and Reduction Forceps
Knochenhaltezaugen
Pinzas para huesos

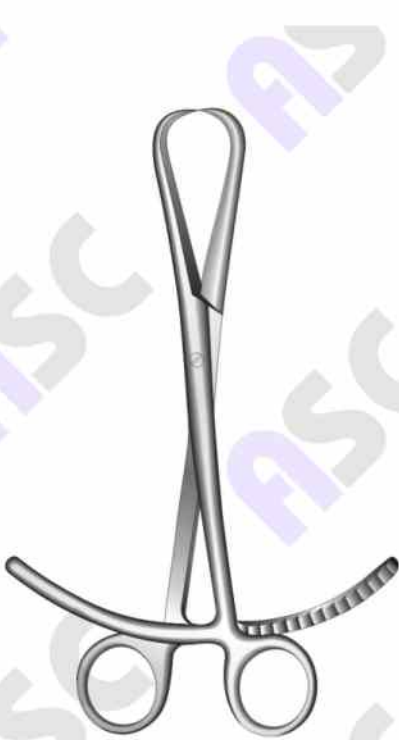

23-4830-15 15 cm / 6"
23-4830-18 18 cm / 7"
23-4830-20 20 cm / 8"
23-4830-30 30 cm / 12"
Bone reduction forceps



Malleolar
23-4835-21

21 cm / 8 1/4"
1 x 1 sharp points.
Grasping forceps for small bones

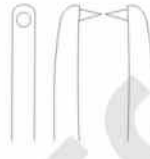

Meyer
23-4840-17

17 cm / 6 3/4"
Reposition forceps for gers,
with drill guide for Kirschner wires
up to diameter 1.0 mm

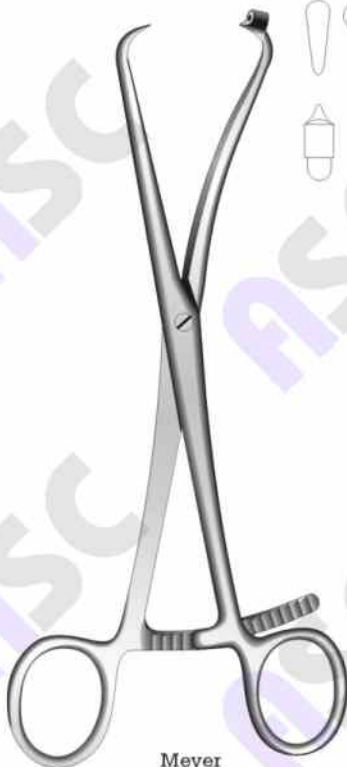

Meyer
23-4845-20

20.5 cm / 8"
Reposition forceps
with drill guide for Kirschner
wires up to diameter 2.0 mm



23-4850-14

14 cm / 5 1/2"



Locke
23-4855-15

15 cm / 6"
Phalangeal forceps serrated jaws
1:1 Teeth



Bone Holding and Reduction Forceps
Knochenhaltezangen
Pinzas para huesos



Bone Holding Forceps
Knochenhaltezaugen
Pinzas para huesos



Requistum
20 cm / 8"

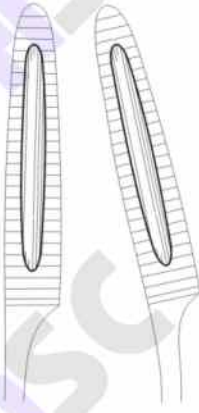

23-4905-20
Straight

23-4906-20
Curved



Van Buren
23-4910-23
23 cm / 9"



23-4915-20
20 cm / 8"



Langenbeck
23-4920-21
21 cm / 8 1/4"



Fergusson
23-4925-21
21 cm / 8 1/4"

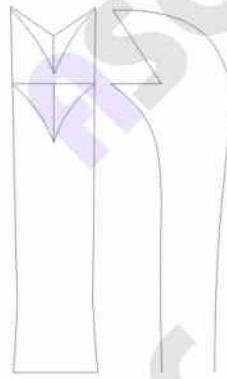

Frosch
23-4930-18
18 cm / 7"



Bone Holding and Reduction Forceps
Knochenhaltezaugen
Pinzas para huesos



Semb
23-4935-19
19 cm / 7½"
Without ratchet



Semb
23-4940-19
19 cm / 7½"
Curved sideways
23-4940-20
20 cm / 8"
Deep teeth with ratchet



Kern
23-4945-12 12 cm / 4¾"
23-4945-15 15 cm / 6"
23-4945-17 17 cm / 6¾"
23-4945-21 21 cm / 8¼"
Without ratchet



Kern
23-4950-12 12 cm / 4¾"
23-4950-15 15 cm / 6"
23-4950-17 17 cm / 6¾"
23-4950-21 21 cm / 8¼"
23-4950-23 23 cm / 9"
With ratchet

Bone Holding Forceps
Knochenhaltezangen
Pinzas para huesos

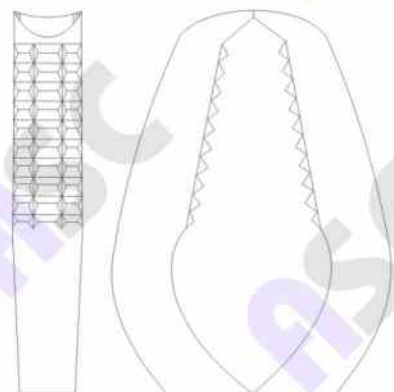
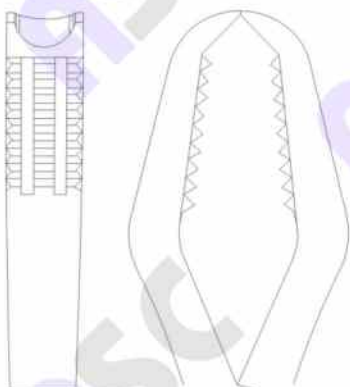

Lane
23-4955-32
32.5 cm / 13"
Bone holding forceps
Light model, without ratchet
23-4956-32
32.5 cm / 13"
Light model, with ratchet
23-4957-42
42.5 cm / 17"
Without ratchet



Lane
23-4960-30
30 cm / 11 1/4"
23-4961-32
32.5 cm / 13"
Bone holding forceps
Standard model, without ratchet
23-4962-32
32.5 cm / 13"
Standard model, with ratchet
23-4963-42
42.5 cm / 17"
With ratchet

Bone Holding and Reduction Forceps
Knochenhaltezaugen
Pinzas para huesos





Verbrugge
16 cm / 6¼"



23-4980-16
Both jaws serrated



23-4981-16
1 jaw serrated
1 jaw plain



Verbrugge Prehenseur

- 23-4985-18** 18 cm / 7"
- 23-4985-24** 24 cm / 9½"
- 23-4985-26** 26 cm / 10¼"
- 23-4985-28** 28 cm / 11"

Serrated jaws



Bone Holding and Reduction Forceps
Knochenhaltezaugen
Pinzas para huesos

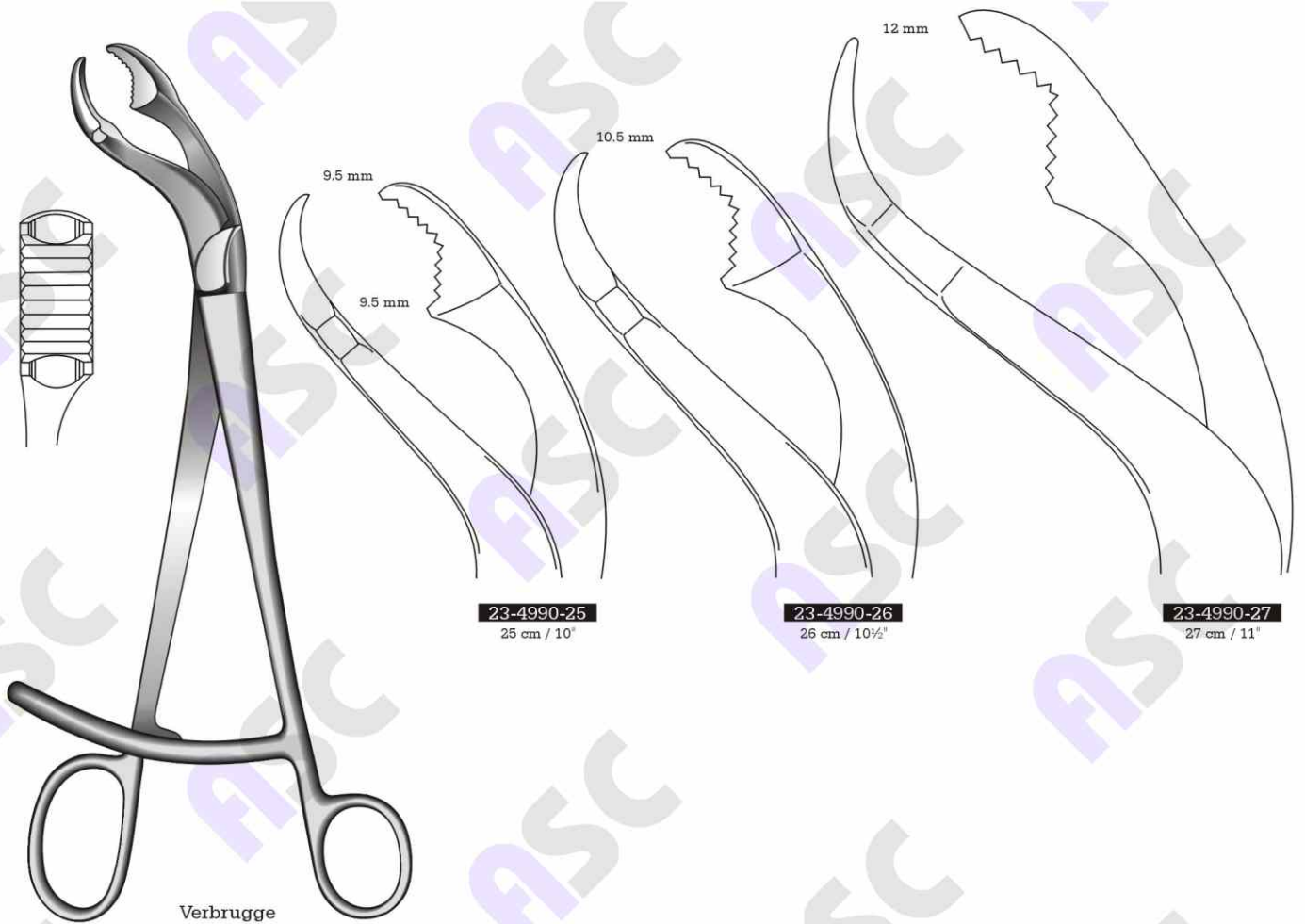

23-4990-25
25 cm / 10"

23-4990-26
26 cm / 10½"

23-4990-27
27 cm / 11"

Verbrugge

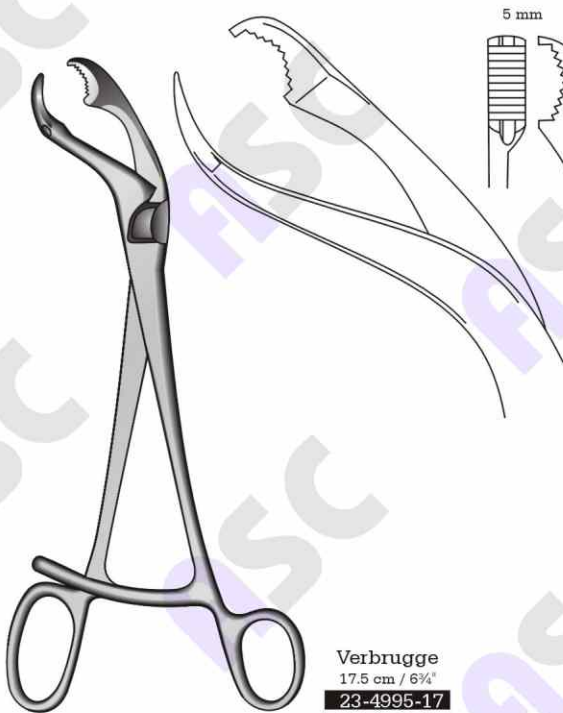

5 mm

23-4995-17
17.5 cm / 6¾"

23-4996-17

Screw joint



Bishop
Adjustable jaw



23-5001-23

23 cm / 9"

23-5001-32

32.5 cm / 13"

Bone Holding Forceps
Knochenhaltezaugen
Pinzas para huesos



23-5005-16 16 cm / 6¼"
23-5005-18 18 cm / 7"

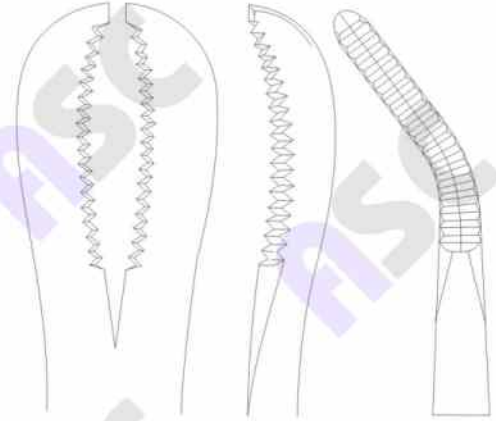
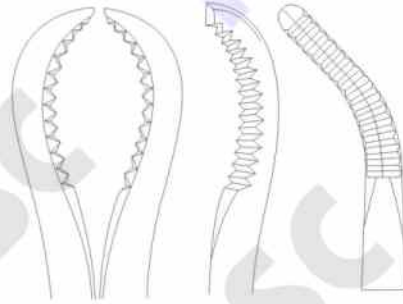

23-5005-20 20 cm / 8"
23-5005-22 22 cm / 8½"
23-5005-24 24 cm / 9½"



Patella Forceps
23-5010-18
18 cm / 7"
2 x 2 sharp teeth
with speed lock



Ollier
23-5015-19 19 cm / 7½"
23-5015-22 22 cm / 8¾"
23-5015-27 27 cm / 10¾"

Bone Holding and Reduction Forceps
Knochenhaltezangen
Pinzas para huesos

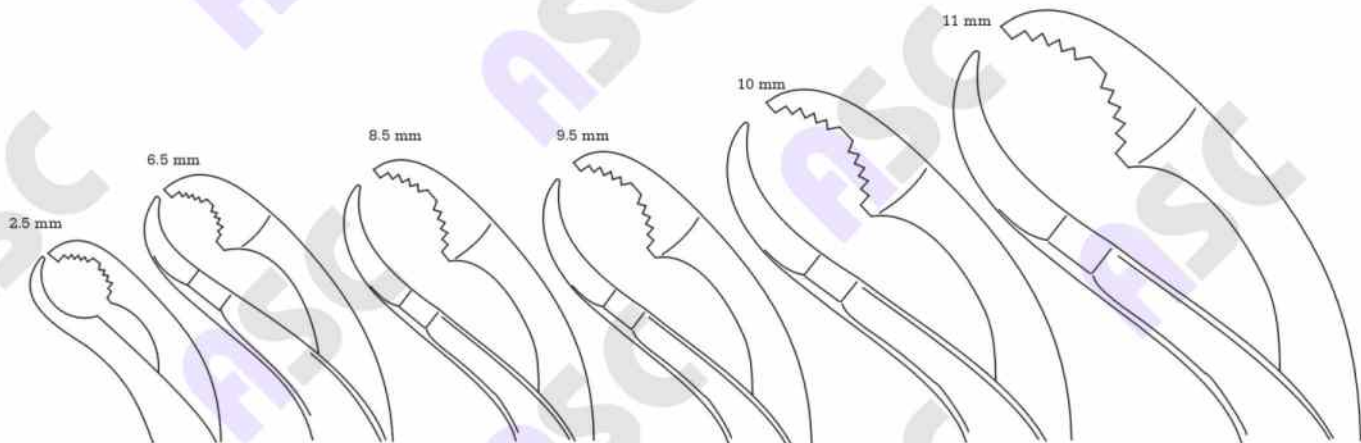

23-5025-15
Standard jaws
23-5026-15
Reverse jaws
23-5027-15
Moveable jaws
15 cm / 6"

23-5025-19
Standard jaws
23-5026-19
Reverse jaws
23-5027-19
Moveable jaws
19 cm / 7½"

23-5025-22
Standard jaws
23-5026-22
Reverse jaws
23-5027-22
Moveable jaws
22 cm / 8½"

23-5025-24
Standard jaws
23-5026-24
Reverse jaws
23-5027-24
Moveable jaws
24 cm / 9½"

23-5025-26
Standard jaws
23-5026-26
Reverse jaws
23-5027-26
Moveable jaws
26 cm / 10¼"

23-5025-28
Standard jaws
23-5026-28
Reverse jaws
23-5027-28
Moveable jaws
28 cm / 11"

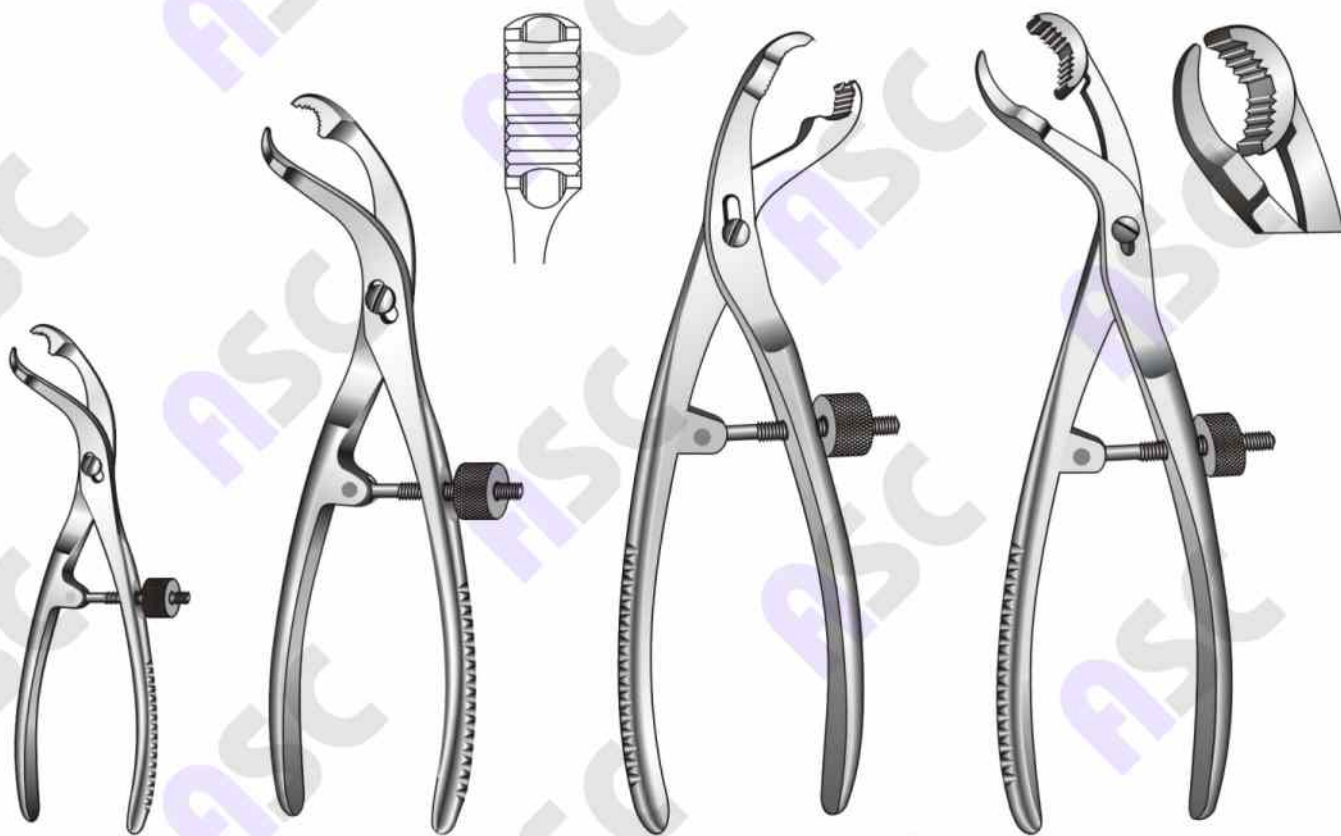

Mini
23-5020-12
12 cm / 4¾"
Special size

Self-Centering Forceps
Standard jaws

Self-Centering Forceps
With thread fixation
Reverse jaws

Verbrugge
28 cm / 11"
With moveable jaws



15 cm / 6"
Mini



18 cm / 7 1/4"

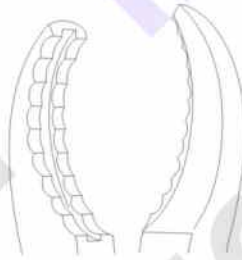

23 cm / 9"



25 cm / 10"

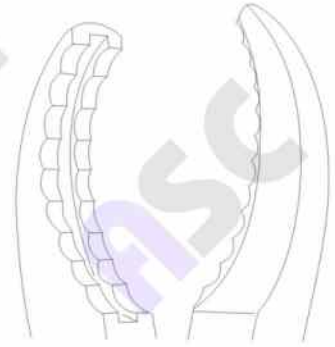

27 cm / 11"



Ulrich
23-5030-13 13 cm / 5", Mini
23-5030-15 15 cm / 6"
23-5030-18 18 cm / 7 1/4"
23-5030-23 23 cm / 9"
23-5030-25 25 cm / 10"
23-5030-27 27 cm / 11"
 Straight



Ulrich
23-5035-13 13 cm / 5",
23-5035-15 15 cm / 6"
23-5035-18 18 cm / 7 1/4"
23-5035-23 23 cm / 9"
23-5035-25 25 cm / 10"
23-5035-27 27 cm / 11"
 Angled



Ulrich
23-5040-27 27 cm / 11"
 Self-retaining forceps
 angular, moveable jaw

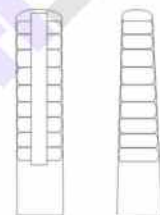

With speed lock
and swivel jaw

Bone Holding and Reduction Forceps
Knochenhaltezaugen
Pinzas para huesos

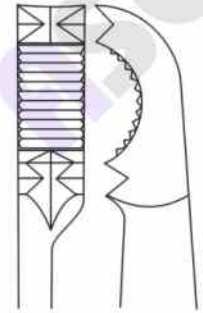
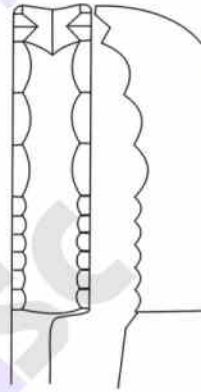
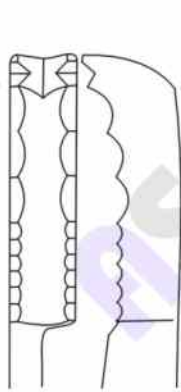

Farabeuf

- 23-5045-19** 19 cm / 7½"
- 23-5045-23** 23 cm / 9"
- 23-5045-26** 26 cm / 10¼"

Adjustable

Farabeuf Lambotte

- 23-5050-19** 19 cm / 7½"
- 23-5050-23** 23 cm / 9"
- 23-5050-26** 26 cm / 10¼"

Adjustable

Tuffier

- 23-5055-27**

27 cm / 10½"

Adjustable



Lambotte
23-5060-22 22 cm / 8³/₄"
23-5060-27 27 cm / 10¹/₂"
23-5060-30 30 cm / 12"
Adjustable

Lambotte
23-5065-22 22 cm / 8³/₄"
23-5065-26 26 cm / 10¹/₂"
23-5065-33 33 cm / 13"

Lambotte
23-5070-19 19 cm / 7¹/₂"
23-5070-23 23 cm / 9"
23-5070-26 26 cm / 10¹/₄"

Bone Holding Clamps, Traction Bar
Knochenhalteklammern, Distraktionsklammern
Pinzas para huesos, Barras de tracción

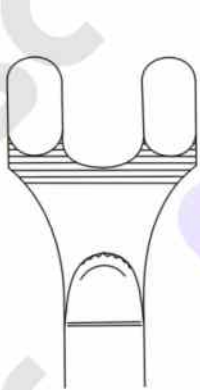

23-5075-08
8,5 cm / 3¼"
Special mini

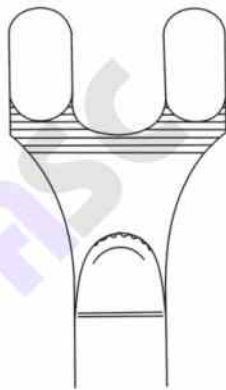

23-5075-12
12 cm / 4"

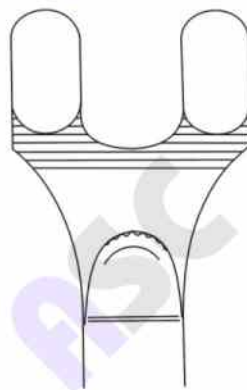

23-5075-18
18 cm / 7"

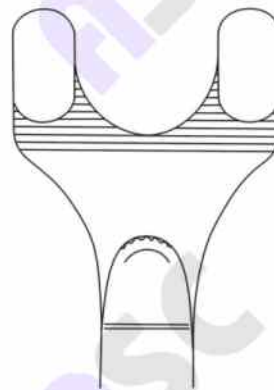

23-5075-20
20 cm / 8"

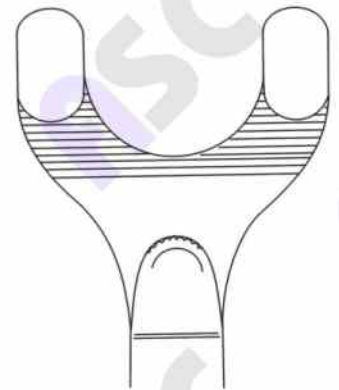

23-5075-22
22 cm / 8½"



Gerster - Lowmann
1 x 2 jaws

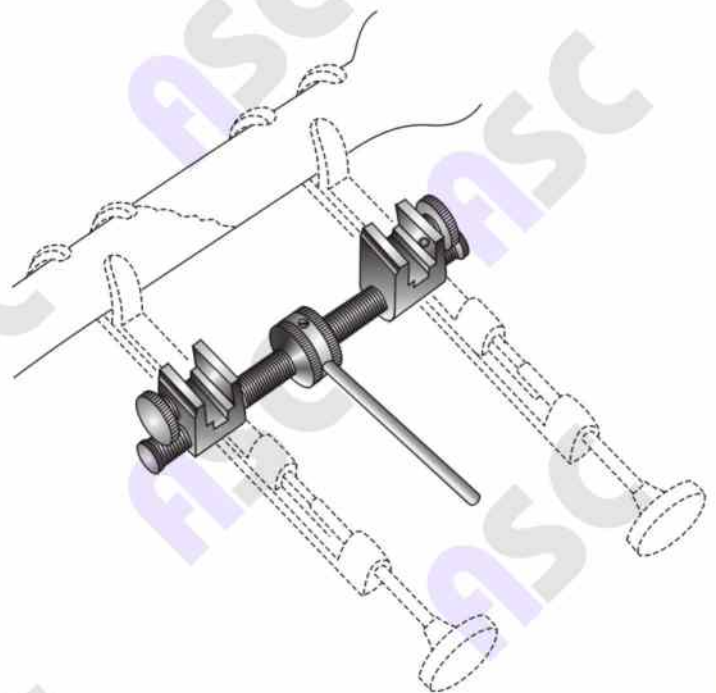
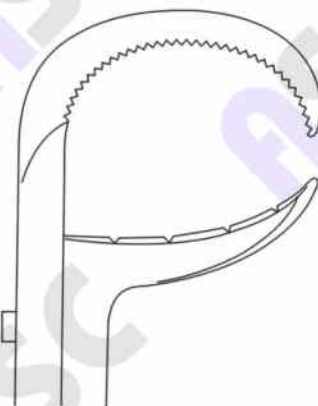

Gerster
23-5080-00

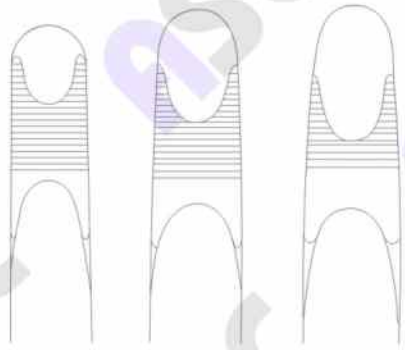

23-5085-12
12 cm / 4 1/4"

23-5085-18
18 cm / 7 1/4"

23-5085-20
20 cm / 8"

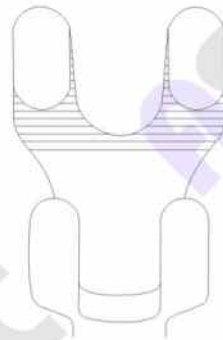

23-5090-18
18.5 cm / 7 1/4"

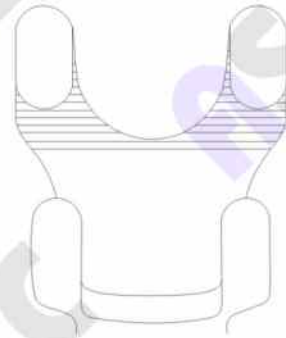

23-5090-20
20 cm / 8"



Lowmann
Bone clamp
1 x 1 jaws



Lowmann
Bone clamp
2 x 2 jaws



Lowman Hoglund
23-5095-12 12 cm / 4 1/4"
23-5095-18 18 cm / 7 1/4"
23-5095-20 20 cm / 8"
Moveable jaws

Pelvic Reposition Forceps
Becken Repositionszangen
Pinzas de enderezamiento



23-5101-19 19 cm / 7½"
23-5101-23 23 cm / 9"
23-5101-25 25 cm / 10"



23-5105-23 23 cm / 9"
23-5105-25 25 cm / 10"



23-5110-40
40 cm / 15"

Pelvic Reposition Forceps
Becken Repositionszangen
Pinzas de enderezamiento

A new shifting technique permits adjusting of the holding area within seconds and without dismantling the instrument.
Easy and quick fixation in both direction by means of 2 nuts



23-5115-40
40 cm / 16"



23-5120-40
40 cm / 16"

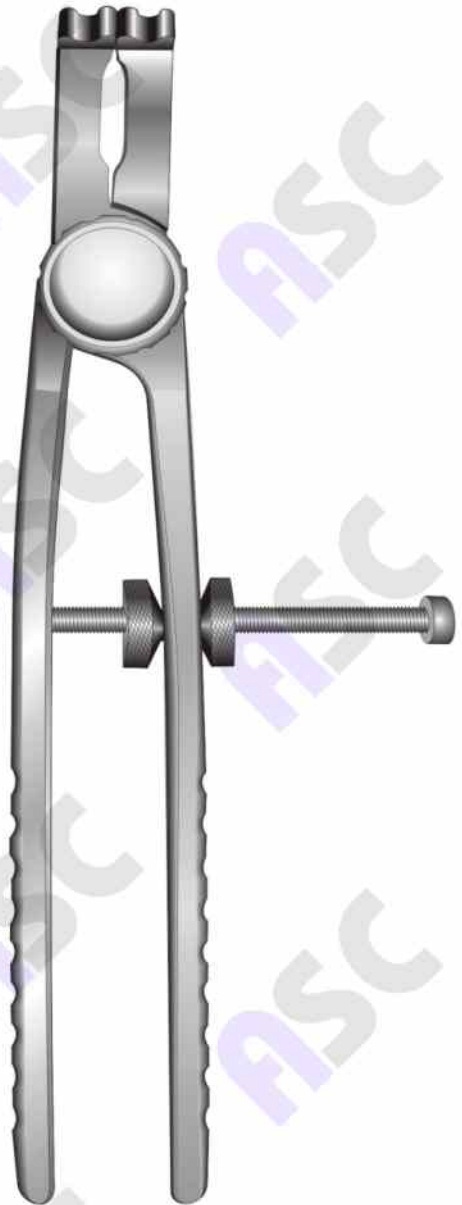

23-5125-00
Reposition forceps

Bone Rongeur Forceps
Hohlmeißelzangen
Pinzas gubias



Mini-Friedman
23-0900-12
12.5 cm / 5"



Friedman
23-0902-14
14 cm / 5½"



Micro Friedman
15 cm / 6"
2 x 6 mm bite
Delicate



23-5140-15
Straight



23-5141-15
Curved



Micro-Friedman
14 cm / 5½"
Extremely delicate



23-5145-14
1.5 x 5 mm bite
Straight



23-5146-14
1.5 x 5 mm bite
Angled 30°



23-5147-14
1.5 x 5 mm bite
Angled 90°

For soft tissue and cancellous bone only



23-5148-00



23-5149-00

Bone Rongeur Forceps
Hohlmeißelzangen
Pinzas gubias



Bone Rongeur Forceps
Hohlmeißelzangen
Pinzas gubias

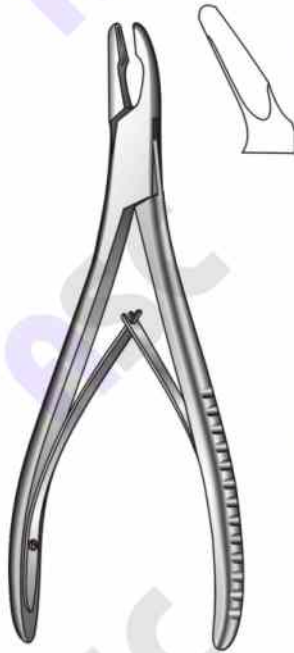

Cleveland
23-0908-17
17 cm / 6 3/4"



Hartmann
23-0920-18
18.5 cm / 7 1/4"

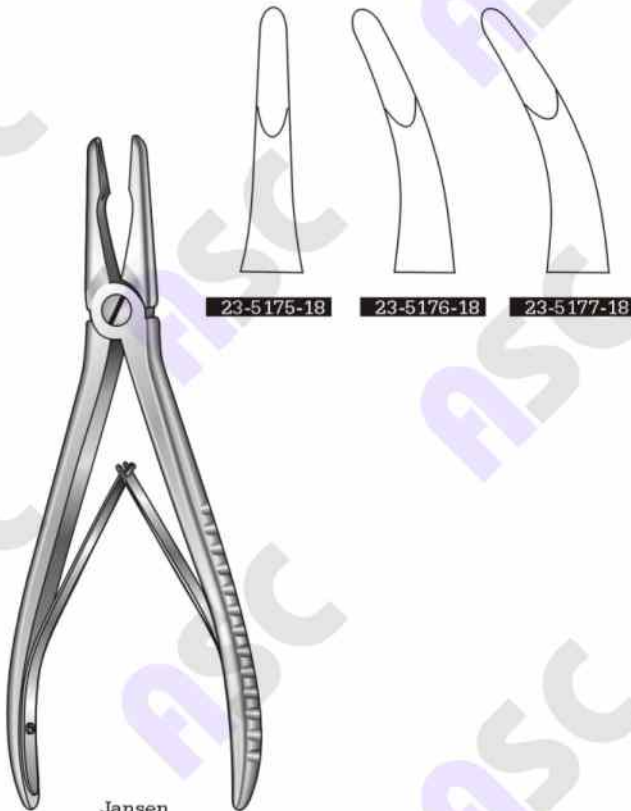

Jansen
18 cm / 7"

23-5175-18

23-5176-18

23-5177-18

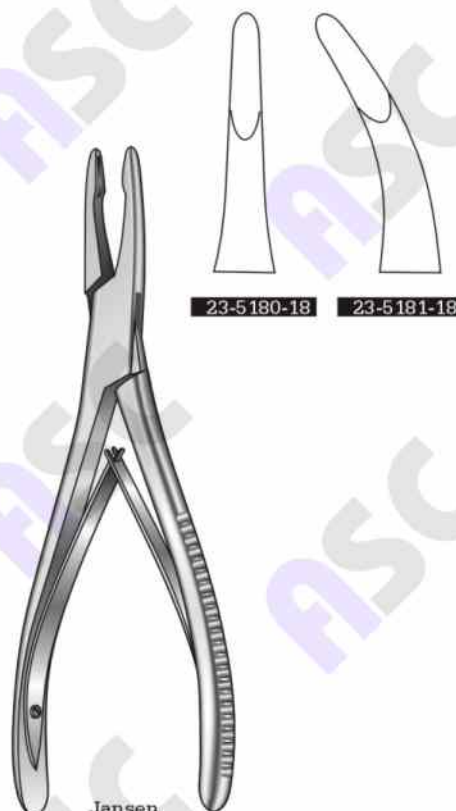

Jansen
18 cm / 7"

23-5180-18

23-5181-18



Marchac
23-5185-18
18 cm / 7"



Blumenthal
15 cm / 6"



Luer
15 cm / 6"

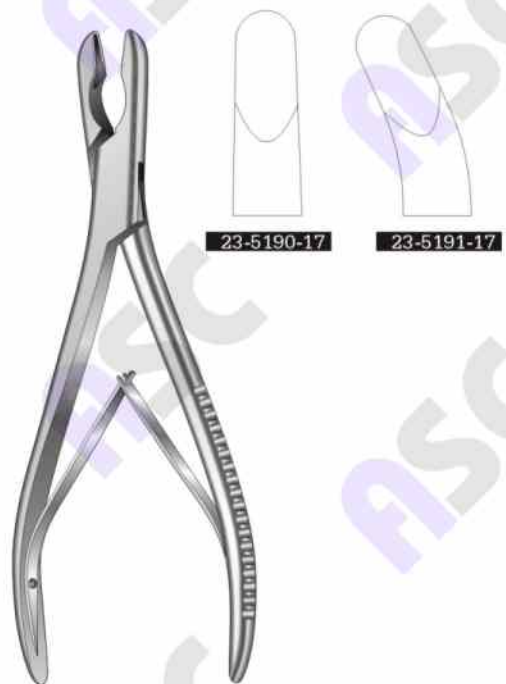

Luer
17 cm / 6 1/2"

Bone Rongeur Forceps
Hohlmeißelzangen
Pinzas gubias

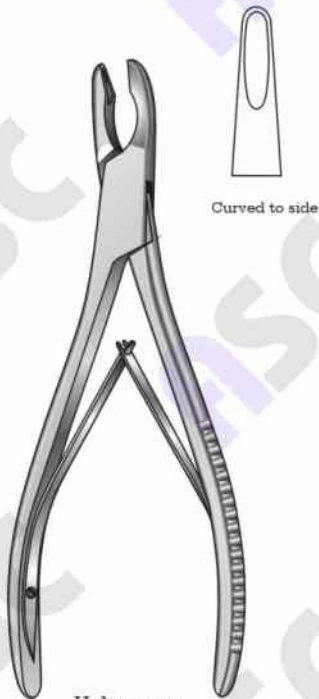

23-5195-17
17 cm / 6 3/4"

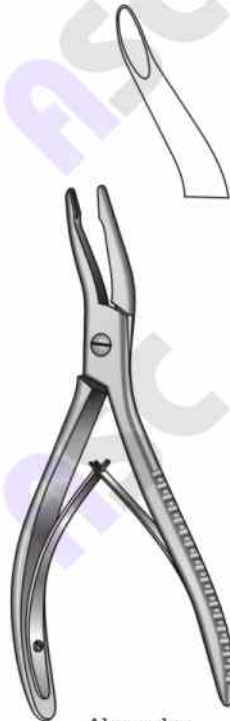

23-5201-14
14 cm / 5 1/2"

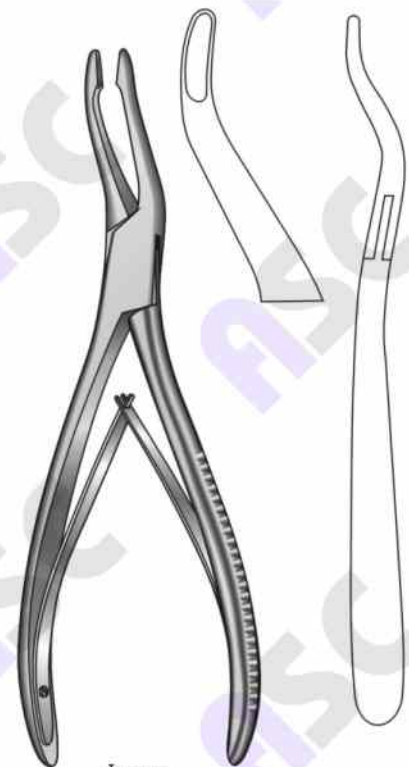

23-5205-19
19 cm / 7 1/2"



23-2145-18
18 cm / 7"



23-5210-20
20.5 cm / 8"



23-5215-20
20.5 cm / 8"



Bone Rongeur Forceps
Hohlmeißelzangen
Pinzas gubias

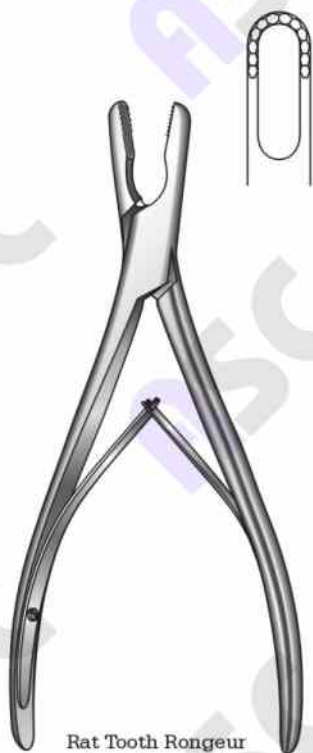

Rat Tooth Rongeur
23-5240-20
20.5 cm / 8"
With teeth 8 x 15 mm bite
Straight

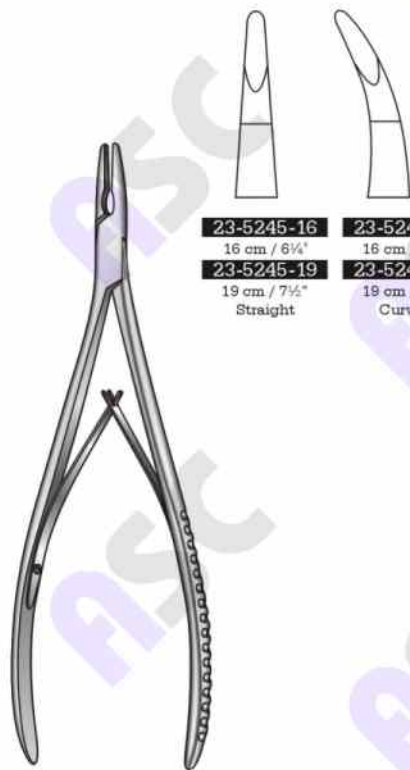

23-5245-16 16 cm / 6 1/4" 23-5245-19 19 cm / 7 1/2" Straight	23-5246-16 16 cm / 6 1/4" 23-5246-19 19 cm / 7 1/2" Curved
--	--

Lempert
2.5 mm bite

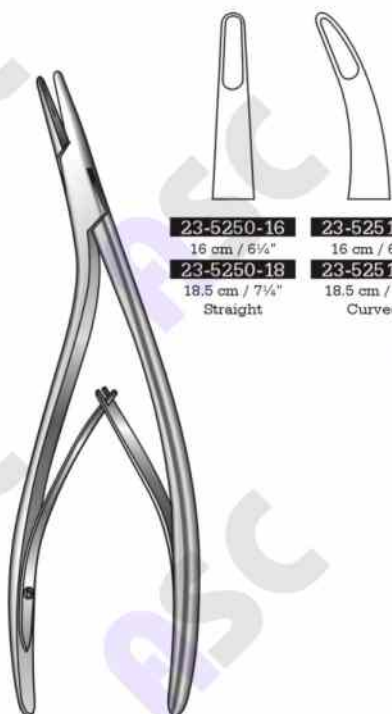

23-5250-16 16 cm / 6 1/4" 23-5250-18 18.5 cm / 7 1/4" Straight	23-5251-16 16 cm / 6 1/4" 23-5251-18 18.5 cm / 7 1/4" Curved
--	--

Juers-Lempert
Straight jaws on curved
handles, delicate, 2.5 mm bite



23-5255-15 2 mm tip 23-5256-15 3 mm tip 23-5257-15 4 mm tip	23-5260-15 2 mm tip 23-5261-15 3 mm tip 23-5262-15 4 mm tip
---	---

Bohler
15 cm / 6"



Zaufal-Jansen
23-0980-18
18 cm / 7"



Mayfield
23-5265-17
17 cm / 6 3/4"



Beyer
18 cm / 7"



23-5270-18 Straight
23-5271-18 Curved



Ruskin
Delicate



- | | | | |
|-------------------|--------------|-------------------|--------------|
| 23-2150-15 | 2 mm | 23-5295-15 | 2 mm |
| 23-5275-15 | 3 mm | 23-5296-15 | 3 mm |
| 23-5276-15 | 4 mm | 23-5297-15 | 4 mm |
| | 15 cm / 6" | | 15 cm / 6" |
| 23-5280-18 | 2 mm | 23-5300-18 | 2 mm |
| 23-2155-18 | 3 mm | 23-0988-18 | 3 mm |
| 23-5281-18 | 4 mm | 23-5301-18 | 4 mm |
| 23-5282-18 | 6 mm | 23-5302-18 | 6 mm |
| 23-5283-18 | 8 mm | 23-5303-18 | 8 mm |
| | 17.5 cm / 7" | | 17.5 cm / 7" |
| 23-5285-20 | 2 mm | 23-5305-20 | 2 mm |
| 23-5286-20 | 3 mm | 23-5306-20 | 3 mm |
| 23-5287-20 | 4 mm | 23-5307-20 | 4 mm |
| 23-5288-20 | 6 mm | 23-5308-20 | 6 mm |
| 23-5289-20 | 8 mm | 23-5309-20 | 8 mm |
| | 20 cm / 8" | | 20 cm / 8" |
| | Straight | | Curved |

Bone Rongeur Forceps
Hohlmeißelzangen
Pinzas gubias



Ruskin
23-5315-23
23 cm / 9"



Smith-Peterson
24 cm / 9½"
3 x 16 mm bite
Laminectomy rongeur

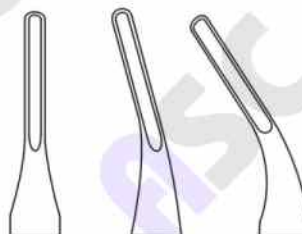

23-5320-24 Straight
23-5321-24 Curved
23-5322-24 Full curved



Marquard
23-5325-20
20 cm / 8"

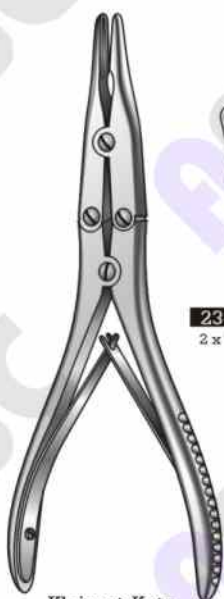

Kleinert-Kutz
15 cm / 6"
Synovectomy rongeur
Slight curve, delicate

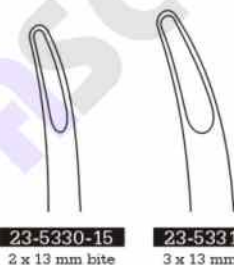

23-5330-15 2 x 13 mm bite
23-5331-15 3 x 13 mm bite



23-5335-15
15 cm / 6"
3 x 8 mm bite
Full curved
Delicate



Kleinert-Kutz
23-5340-15
15 cm / 6"
2 x 10 mm bite
Synovectomy rongeur
Curved on side
Delicate



23-5345-23
2 mm

23-5346-23
3 mm

23-5347-23
4 mm



Echin
23 cm / 9"



Stille-Ruskin
23-5350-23
23 cm / 9"



Semb
23-5355-22
22.5 cm / 9"



Stille
23-5360-23
23 cm / 9"



Frykholm
23-5365-24
24 cm / 9½"

Bone Rongeur Forceps
Hohlmeißelzangen
Pinzas gubias



Leksell-Stille
24 cm / 9½"
Curved 15°

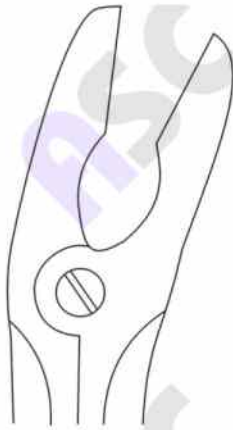

23-5370-24
3 x 16 mm bite



23-5371-24
4 x 16 mm bite



23-5372-24
5 x 16 mm bite



23-5373-24
6 x 16 mm bite



23-5374-24
7 x 16 mm bite



23-5375-24
8 x 16 mm bite



Leksell
23 cm / 9"
Curved 50°



23-5380-23
3 x 13 mm bite



23-5381-23
4 x 13 mm bite



23-5382-23
5 x 13 mm bite



23-5383-23
6 x 13 mm bite



23-5384-23
7 x 13 mm bite



23-5385-23
8 x 13 mm bite

Bone Rongeur Forceps
Hohlmeißelzangen
Pinzas gubias



23-5401-23 23 cm / 9"
23-5401-27 27 cm / 10½"



23-5402-23
23-5402-27



23-5390-22
23-5391-22
23-5392-22
23-5393-22
23-5394-22

4 mm
6 mm
8 mm
10 mm
12 mm



23-5395-22
23-5396-22
23-5397-22
23-5398-22
23-5399-22



Stille-Luer
22 cm / 8½"
8 mm



Stille-Luer

Bone Rongeur Forceps
Hohlmeißelzangen
Pinzas gubias

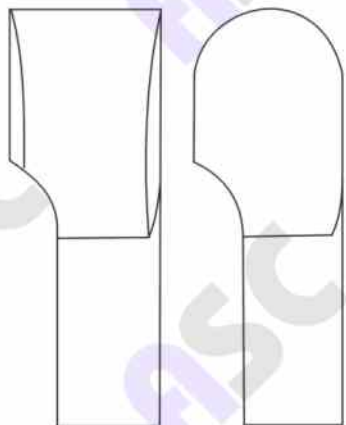

23-5405-30

23-5406-30



23-5410-36

3 mm



23-5415-00

3 mm



23-5411-36

5 mm



23-5416-00

5 mm



23-5412-36

6 mm



23-5417-00

6 mm



23-5413-36

8 mm



23-5418-00

8 mm

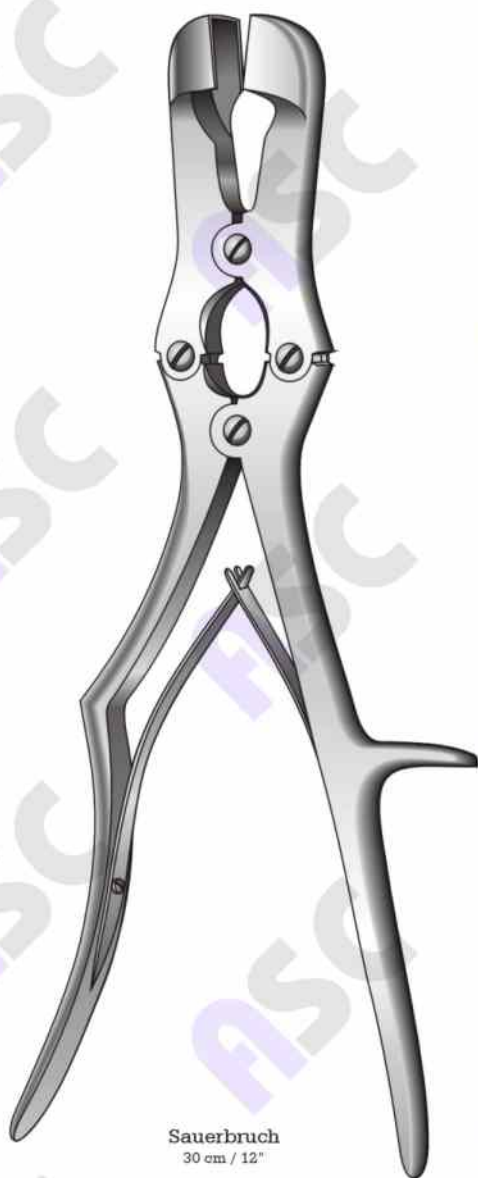

Sauerbruch
30 cm / 12"



Syvert
36 cm / 14 1/2"

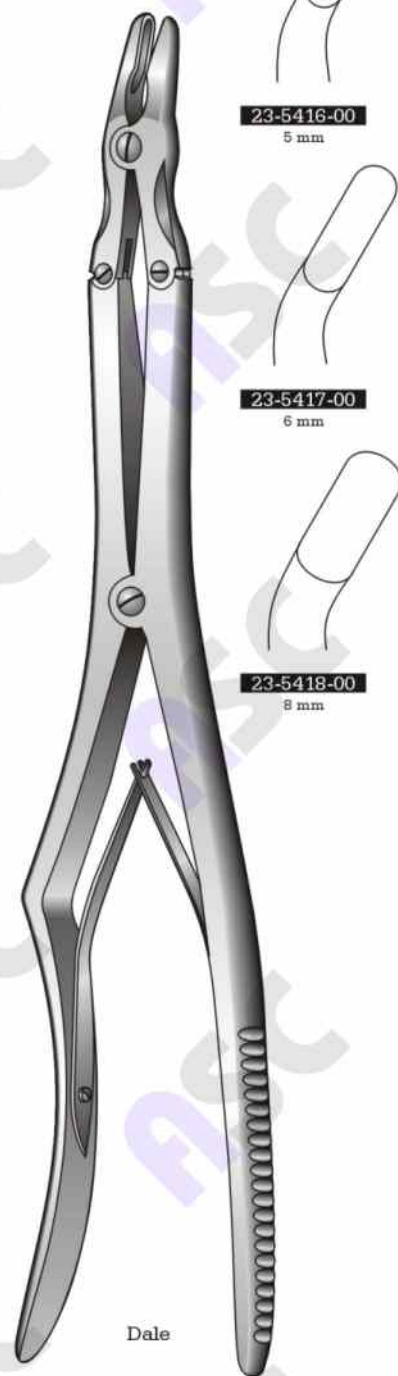

Dale

Bone Cutting Forceps
Knochensplitterzangen
Pinzas cortantes para huesos



Liston



23-5420-14
14 cm / 5½"

23-5420-17
17 cm / 6¾"

23-5420-19
19 cm / 7½"

23-5420-22
22 cm / 8¾"



Liston



23-5425-14
14 cm / 5½"

23-5425-17
17 cm / 6¾"

23-5425-19
19 cm / 7½"

23-5425-22
22 cm / 8¾"



Markwalder
23-5430-12
12 cm / 4¾"



Cleveland
23-5435-15
15 cm / 6"



Cleveland
23-1040-15
15 cm / 6"
23-1040-17
17 cm / 6¾"



Bone Cutting Forceps
 Knochen splitterzangen
 Pinzas cortantes para huesos

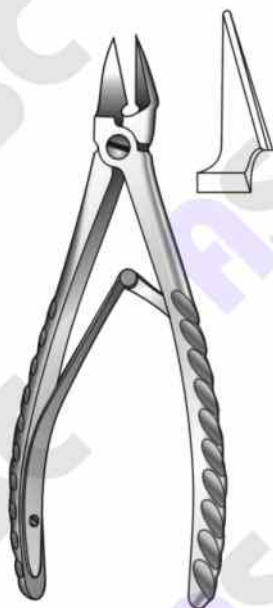

Stamm
 23-5440-15
 15 cm / 6"



Kazanjian
 23-5445-18
 18.5 cm / 7 1/4"

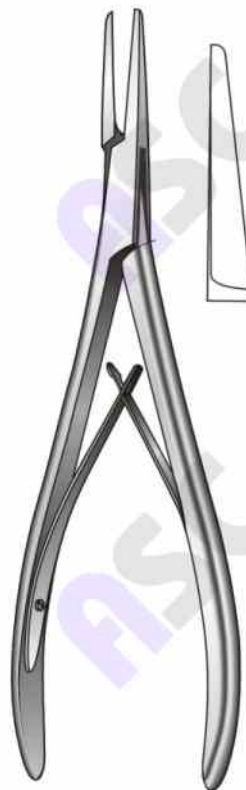

Tessier
 23-5450-20
 20.5 cm / 8"
 Slim pattern



Markwalder
 23-5455-20
 20 cm / 8"

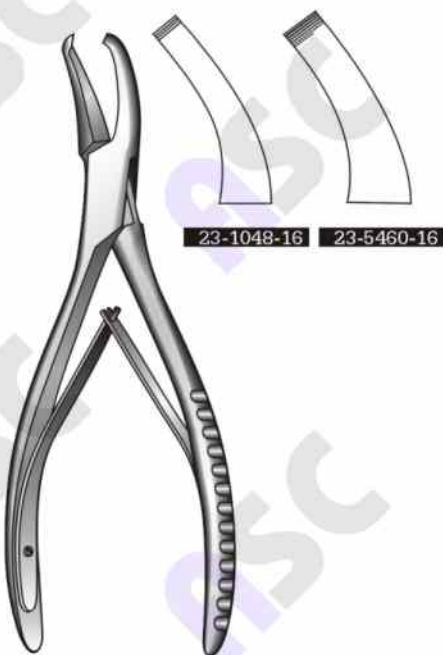

Cleveland
 23-1048-16 23-5460-16
 16 cm / 6 1/4"



Bohler
 23-5465-15
 15 cm / 5 1/4"



Bohler
 23-5470-14
 14.5 cm / 5 3/4"



Velpeau
 23-5475-24
 24 cm / 9 1/2"

Bone Cutting Forceps
Knochensplitterzangen
Pinzas cortantes para huesos



Böhler
23-5480-14
14.5 cm / 5 7/8"



23-5485-17
17 cm / 6 3/4"



McIndoe
23-5490-17
17.5 cm / 7"



Ruskin-Liston
18.5 cm / 7 1/4"

23-1051-18 **23-1052-18**



Liston
23-5495-24
24 cm / 9 1/2"

Bone Cutting Forceps
Knochensplitterzangen
Pinzas cortantes para huesos

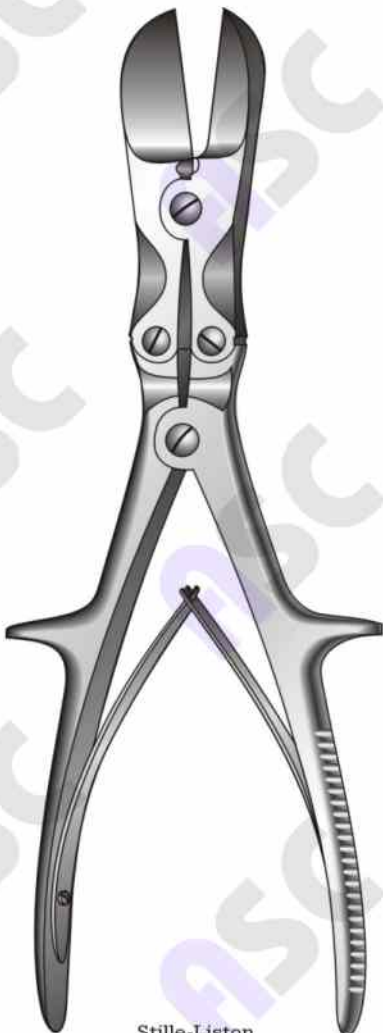
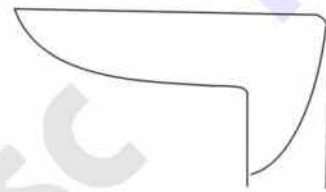

Stille-Liston
23-5501-27
27 cm / 10 1/2"

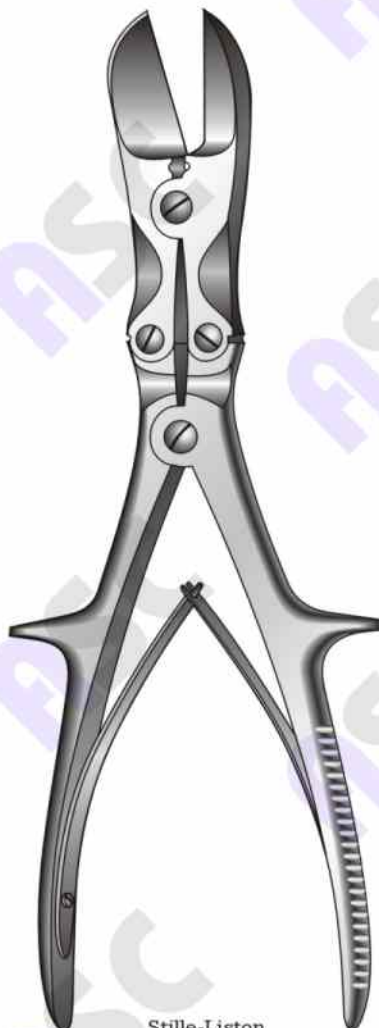

Stille-Liston
23-5505-27
27 cm / 10 1/2"

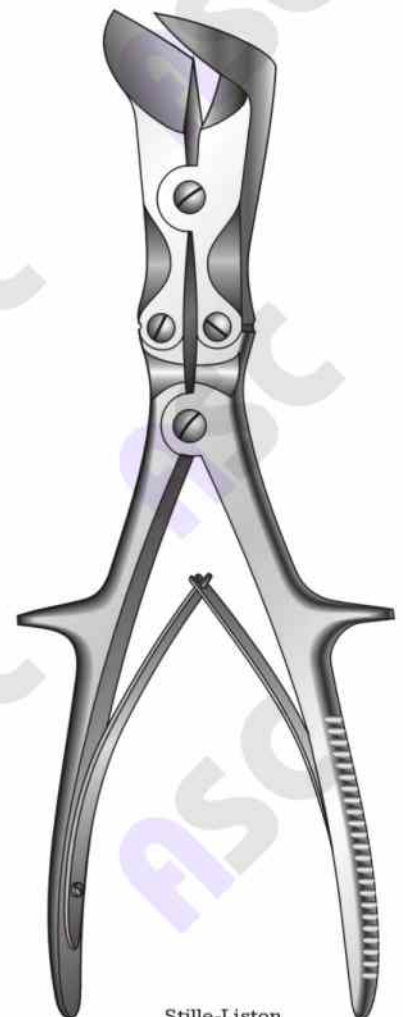

Stille-Liston
23-5510-27
27 cm / 10 1/2"

Bone Cutting Forceps
Knochensplitterzangen
Pinzas cortantes para huesos



Liston-Key
23-5515-27
27 cm / 10½"



Semb
23-5520-24
24 cm / 9½"

Wire Twisting Forceps
Drahtzwirbelzangen
Pinzas para torcer hilos



23-5525-15T
15.5 cm / 6"



Corwin
23-5530-16T
16 cm / 6 1/4"



23-0601-15T
15 cm / 6"



23-0621-20T
20 cm / 8"



23-5535-18T
18.5 cm / 7 1/4"
23-5535-20T
20 cm / 8"

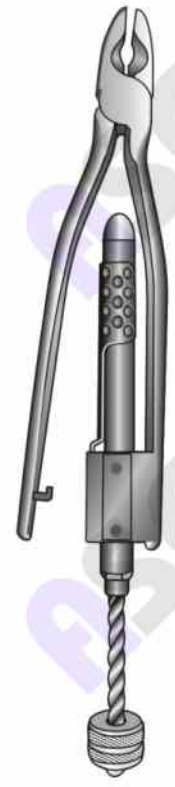

23-5540-00T
Jet wire twister

Wire Tightening Pliers, Flat Nose Pliers
Drahtspannerzangen, Flachzangen
Hilos tensores, Alicates de pico plano

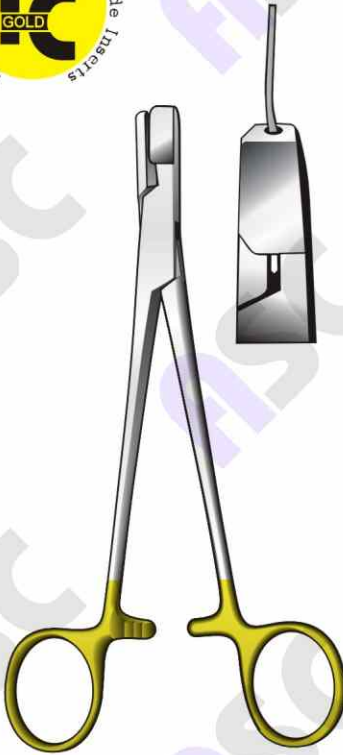

23-5550-17T

17 cm / 6 3/4"

Holding forceps for cerclage wire, with lateral jaws to avoid wire slipping off

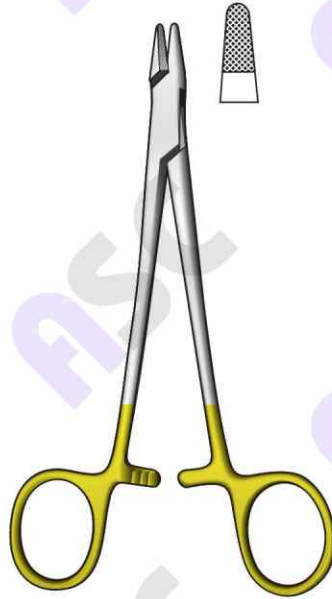

23-5545-15T

15 cm / 6"

Wire tightening pliers
ligature pliers



Baumgartner
23-5560-20T

20 cm / 8"

Wire twister, ligature forceps



18 cm / 7"
Parallel grip



23-5565-18T



23-5566-18T



23-5567-18T

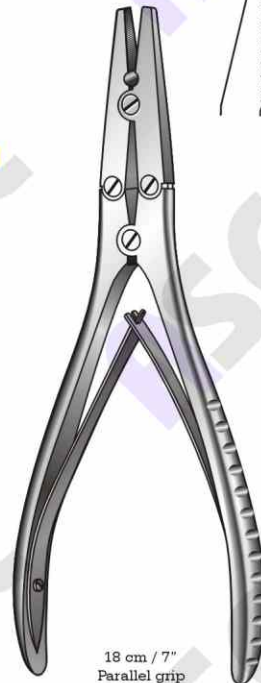

18 cm / 7"
Parallel grip



23-5570-18T



23-5571-18T

Wire Twister, Flat Nose Pliers, Wire Cutting Pliers
Flachzangen, Drahtkneifzangen
Alicates planos, Alicates para cortar alambre



23-5575-16
16 cm / 6 1/4"
Heavy pattern



23-5580-15
15 cm / 6"
For bending & cutting



23-5585-16
16.5 cm / 6 1/2"

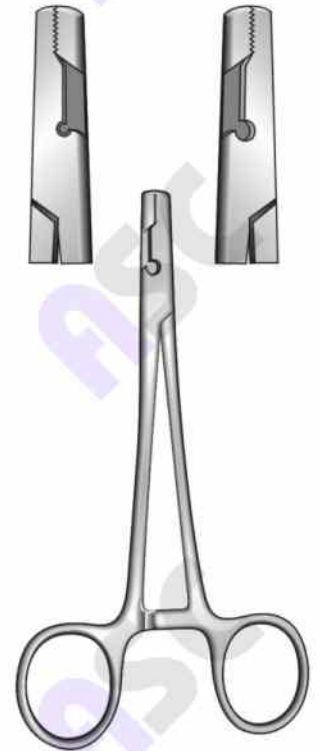

23-5590-00
Wire twister / Shear cutter
cuts wire up to 18g, twisted double



17 cm / 6 3/4"



23-5595-17



23-5596-17
With crosswise
groove



Hakstock
23-5601-16
16 cm / 6 1/4"
With longitudinal groove

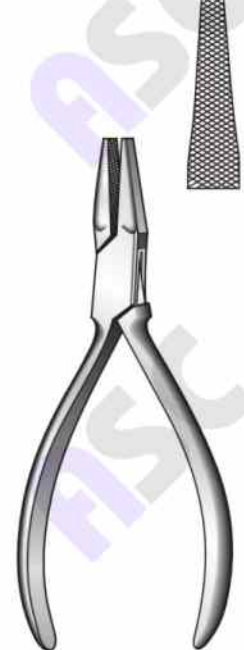

23-5605-14
14 cm / 5 1/2"

Flat Nose Pliers, Wire Cutting and Twisting Pliers
Flachzangen, Drahtkneifzangen, Drahtzangen
Alicates planos, Alicates para cortar alambre

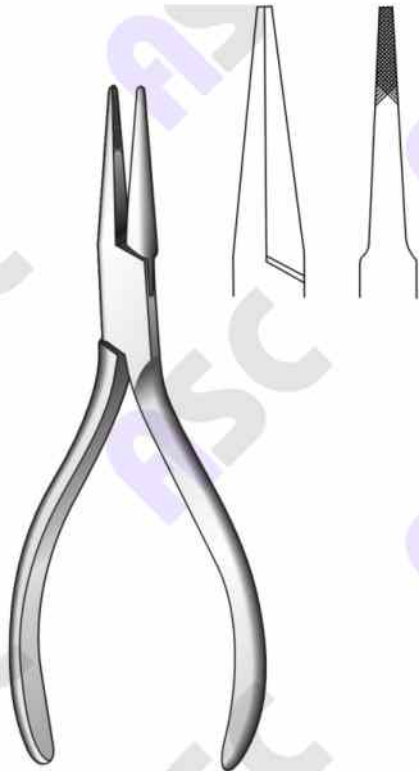

23-5625-15
15 cm / 6"
Flat nose plier
2 mm tip for cerage wire
Delicate

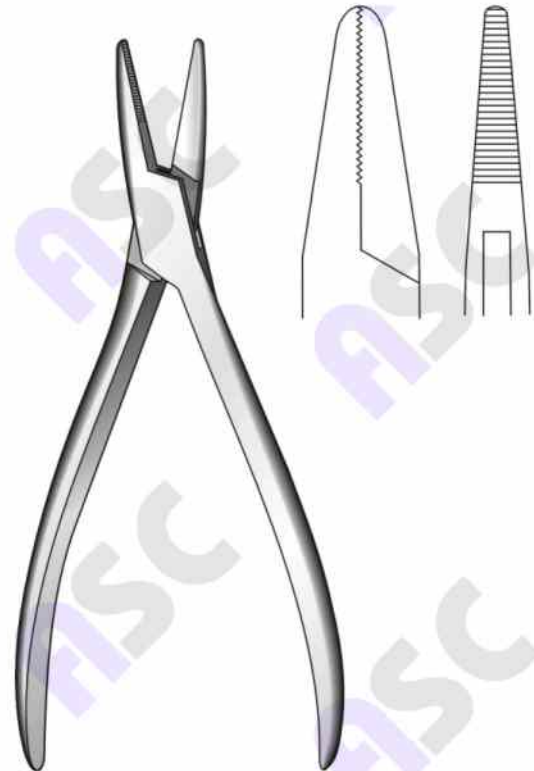

23-5630-19
19 cm / 7½"
3 mm tip
Narrow nose
wire pulling forceps

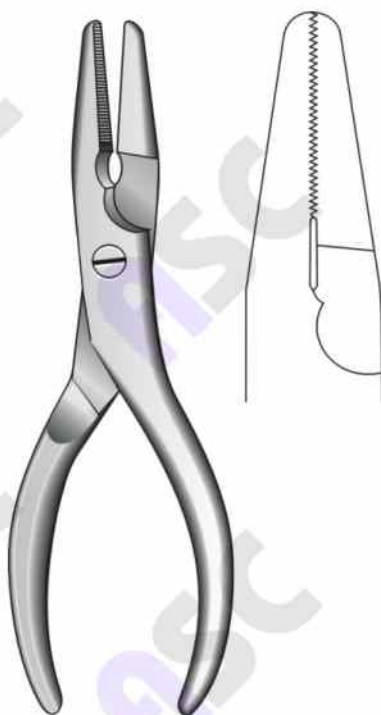

23-5635-16
16.5 cm / 6½"
3 mm tip
Flat nose plier

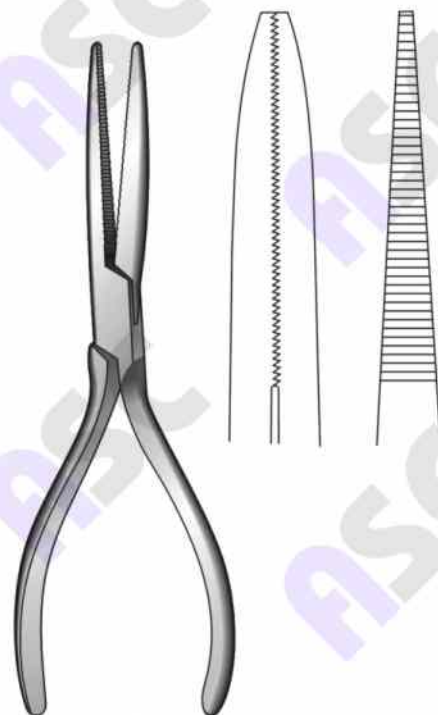

23-5640-18
18 cm / 7"
Jaw length: 2½"
2 mm tip
Parallel grooved jaws
Long jaw needle nose plier

Wire Tighteners, Drill Chucks, Wire Twisters
Drahtspanner, Spannfutter, Drahtzwirbel
Hilos tensores, Mandril de sujeción, Torcer de alambre



Jacobs

23-3501-00

Small

23-3502-00

Large

Stainless steel



23-3505-00

Key for Jacobs chuck
Stainless steel



23-5655-00

Wire tightener



23-3510-00

Small

23-3511-00

Large

Chuck chrome plated



23-3512-00

Key for
chrome plated chuck



23-5670-18

18 cm / 7"

Small cerclage wire twister
anodized aluminum handle



23-5675-00

Large

anodized aluminum handle



23-5680-00

23-5685-00

Wire twister small
Stainless steel



23-5690-18

18 cm / 7"

Large cerclage wire twister
anodized aluminum handle
Stainless steel tip

Drill Guide, Wire Twister and Wire Cutting Pliers, Trephines
Flachzangen, Drahtkneifzangen, Trephine
Alicates planos, Alicates para cortar alambre, Trepanos



Hudson
10 cm / 4"
Trephine

	Hole size
23-4030-12	12.7 mm / 1/2"
23-4030-19	19 mm / 3/4"
23-4030-25	25.4 mm / 1"
23-4030-31	31.75 mm / 1 1/4"
23-4030-38	38.1 mm / 1 1/2"

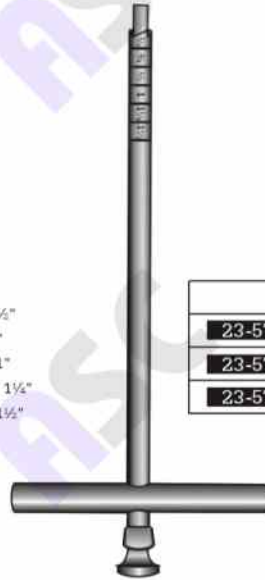

Michele
Trephine

		Inside Ø	Outside Ø
23-5730-00	Small	3 mm	5 mm
23-5731-00	Medium	4 mm	6 mm
23-5732-00	Large	6 mm	8 mm

Facilitates removal of wire and broken bone screws.

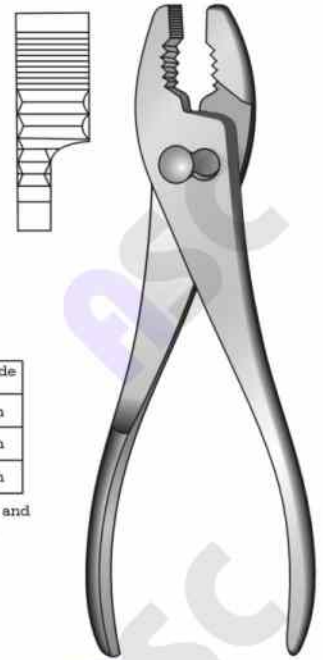

23-5695-20
20 cm / 8"
Slip joint plier
10 mm tip
Maximum opening 2"

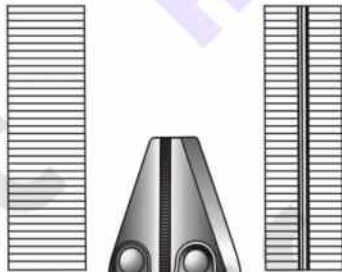

23-5710-13 13 cm / 5 1/4"
23-5710-17 17 cm / 6 1/2"



23-5715-17 17 cm / 6 1/2"
23-5715-12 12.5 cm / 5"
With side cutter



23-5720-18
18 cm / 7"

Heavy Duty Locking Pliers & Needle Nose Locking Pliers
with a new reinforced, more durable jaw.

- Heavy duty jaws lock securely onto pins.
- Reinforced jaw hinge and housing are more rigid to
- Help prevent side to side shifting.
- Made from 300 and 400 series Surgical grade
- Stainless steel.
- Will not chip or contaminate other instrumentation
- Adjustment screw for easy control of jaw opening
- One handed, quick release self-locking lever.
- Available in three sizes.



23-5760-17
17.5 cm / 6 7/8"
Tip width 7 mm
Maximum opening 1"
Small



23-5760-20
20 cm / 8"
Tip width 9 mm
Maximum opening 1"
Medium

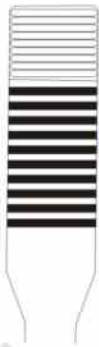

23-5760-25
25.5 cm / 10"
Tip width 13 mm
Maximum opening 1"
Large



23-5765-24
24 cm / 9 1/2"
Length of jaw 2 1/2"
Tip width 5 mm
Jaws are parallel at 3 mm



23-5765-30
30 cm / 12"
Length of jaw 3"
Tip width 7 mm
Jaws are parallel at 5 mm
Large



Locking plier



Needle nose locking plier

Wire Cutting Pliers
Drahtkneifzangen
Alicates para cortar alambre



"Diamant"
23-5770-16
16 cm / 6 1/4"



23-5775-16
16 cm / 6 1/4"
for soft wires up to 2.5 mm Ø
for hard wires up to 2.0 mm Ø



23-5780-00
16 cm / 6 1/4"
for soft wires up to 2.4 mm Ø
for hard wires up to 1.8 mm Ø



23-5785-16T 16 cm / 6 1/4"
23-5785-18T 18 cm / 7"
23-5785-20T 20 cm / 8"



23-5790-14T 14 cm / 5 1/2"
23-5790-16T 16 cm / 6 1/4"
23-5790-18T 18 cm / 7"



For up to
1.6 mm

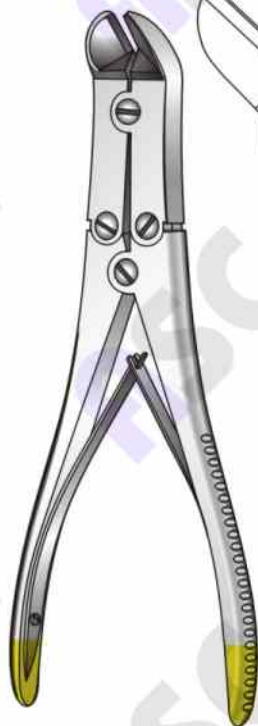

23-5795-22T
22 cm / 8 3/4"
For soft wires up to 2.6 mm Ø
For hard wires up to 2.2 mm Ø

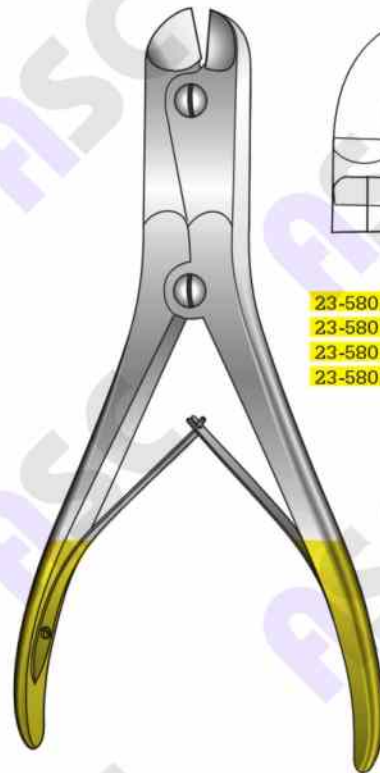
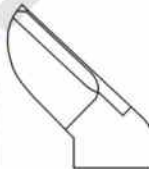

23-5801-14T 14 cm / 5 1/2"
23-5801-16T 16 cm / 6 1/4"
23-5801-18T 18 cm / 7"
23-5801-22T 22 cm / 8 1/2"



For soft wires up to 3 mm Ø
For hard wires up to 2.2 mm Ø

Wire Cutting Pliers
Drahtkneifzangen
Alicates para cortar alambre



23-5805-15

15 cm / 6"

For soft wires up to 2.0 mm Ø
For hard wires up to 1.2 mm Ø



23-5810-24

24 cm / 9½"



23-5815-18T

18 cm / 7"

For soft wires up to 2 mm Ø
For hard wires up to 1.5 mm Ø



23-5820-17T

17 cm / 6¾"

Angled slender pattern for wire removal (for soft wire up to 0.9 mm Ø) after sternum suture



23-5825-22T

22 cm / 8¾"

For soft wire up to 3.5 mm Ø
For hard wire up to 2.5 mm Ø

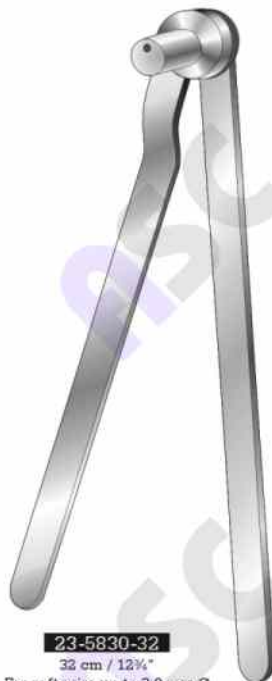

23-5830-32

32 cm / 12¾"

For soft wire up to 3.0 mm Ø
For hard wire up to 3.0 mm Ø

Cutter for cutting off Kirschner wires tibia head screws, bolts & pins up to 3 mm Ø

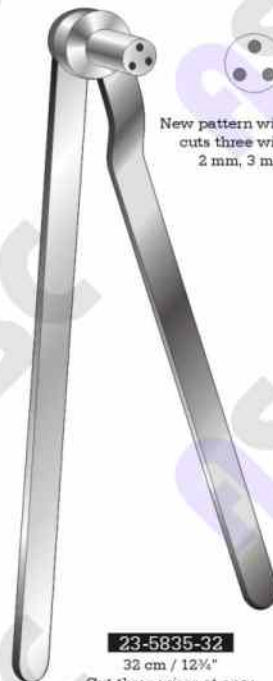

23-5835-32

32 cm / 12¾"

Cut three wires at once
For soft wire up to 4.0 mm Ø
For hard wire up to 3.0 mm Ø

New pattern with three holes cuts three wires at once
2 mm, 3 mm, 4 mm Ø

Wire Cutting Pliers
Drahtkneifzangen
Alicates para cortar alambre

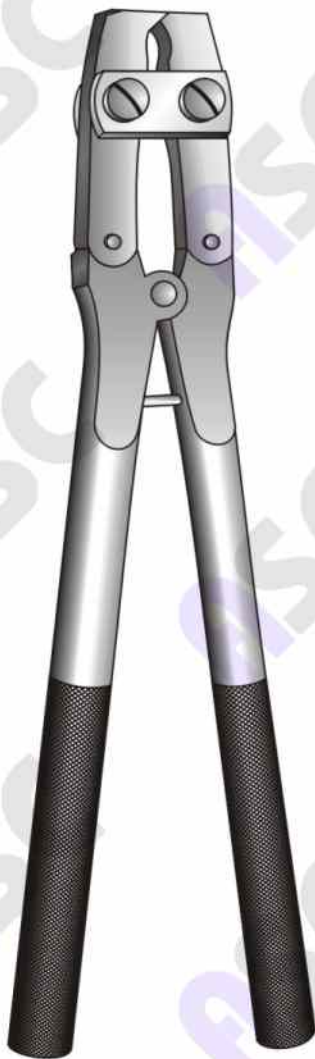

23-5840-25
25 cm / 10"
For wires up to 3.0 mm
Head cutter

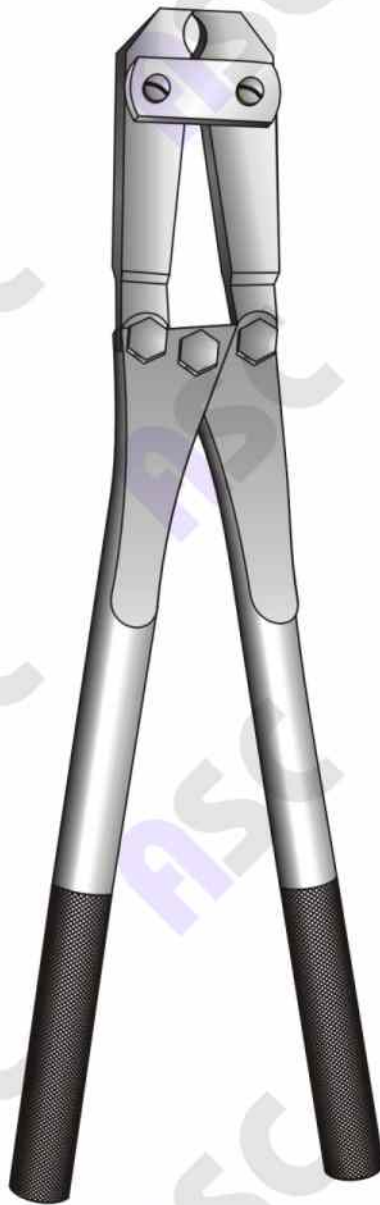

23-5845-38
38 cm / 15"
For wires up to 4.0 mm
Head cutter

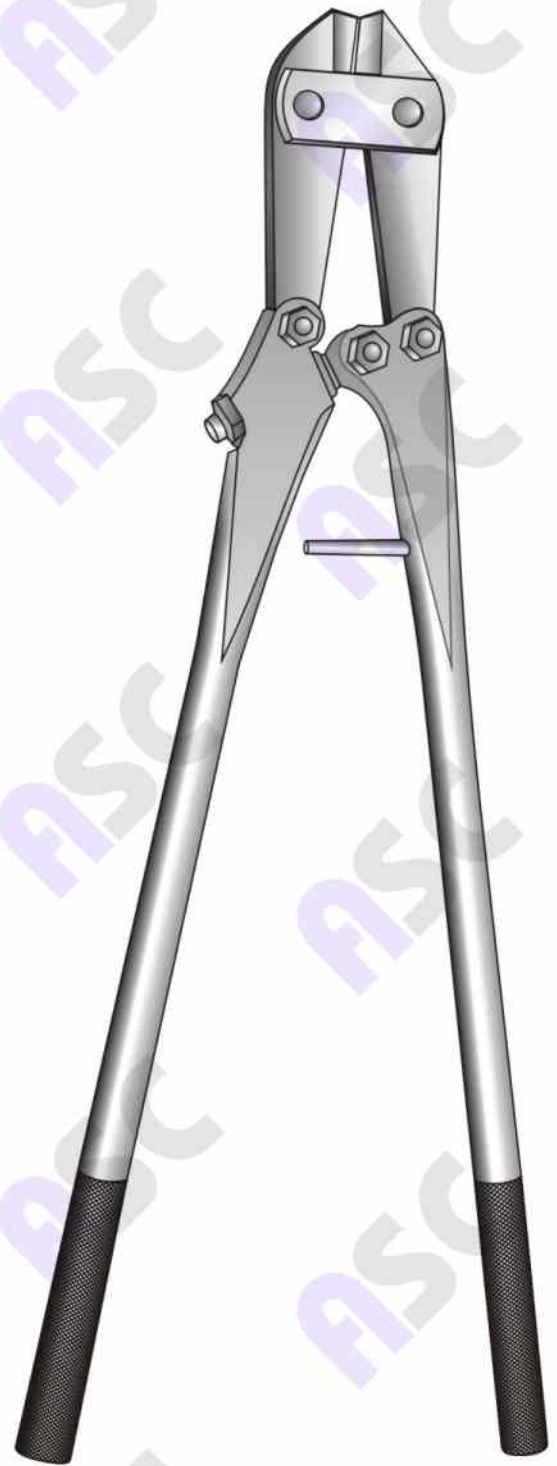

23-5850-38T 38.5 cm / 15" For wire 5 mm
23-5850-45T 45 cm / 17½" 6 mm
23-5850-56T 56 cm / 22" 7.5 mm
TC wire cutter



23-5855-30
30 cm / 12"

23-5855-47
47 cm / 18½"

Cutter for cutting off kirschner wires,
tibia head screws
bolts, pins up to 6 mmØ

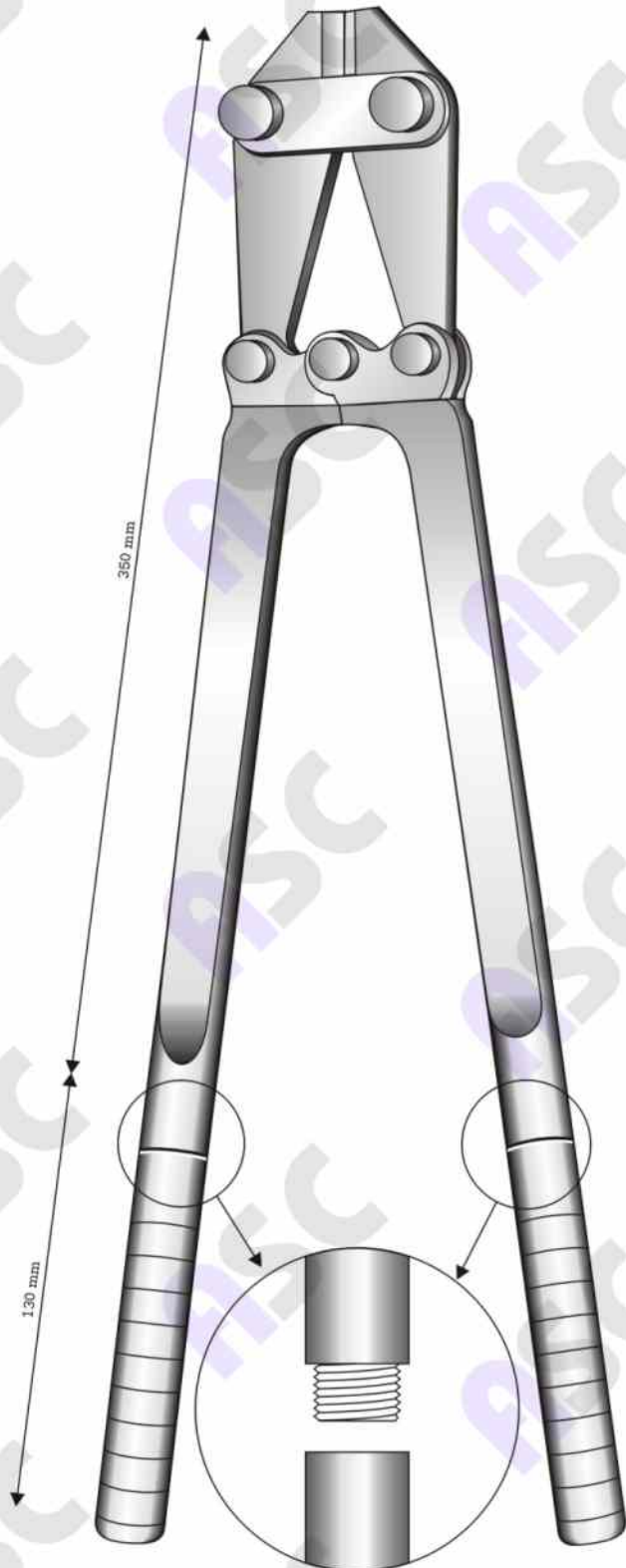

23-5860-48
48 cm / 19"

Cutter for cutting off wires,
head screws
and pins up to 6 mm

Wire Cutting Pliers
Drahtkneifzangen
Alicates para cortar alambre



23-5865-24
24 cm / 9½"
Plate cutting forceps
For cutting stainless steel
mini plates up to 1 mm



23-5870-38
38 cm / 15"
Double action pin cutter
Heavy duty with Carb-N-Sert cutting blades
cut upto 3/16"Ø
Stainless steel

Extension Bows
Extensionsbügel
Estribos para extensión

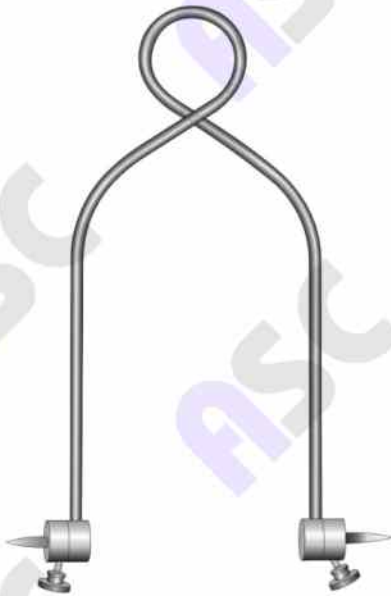

- 23-5875-09** 16 x 9 cm, 5/4" x 3 1/2"
For arm
- 23-5875-11** 21 x 11 cm, 8 1/4" x 4 1/2"
For thigh and knee
- 23-5875-15** 21 x 15 cm, 8" x 6"
- For femur and knee
- 23-5875-12** 8.5 x 12 cm, 3 1/2" x 4 3/4"
- 23-5875-17** 11 x 17 cm, 4 1/4" x 6 1/4"
- 23-5875-23** 15 x 23 cm, 6" x 9"

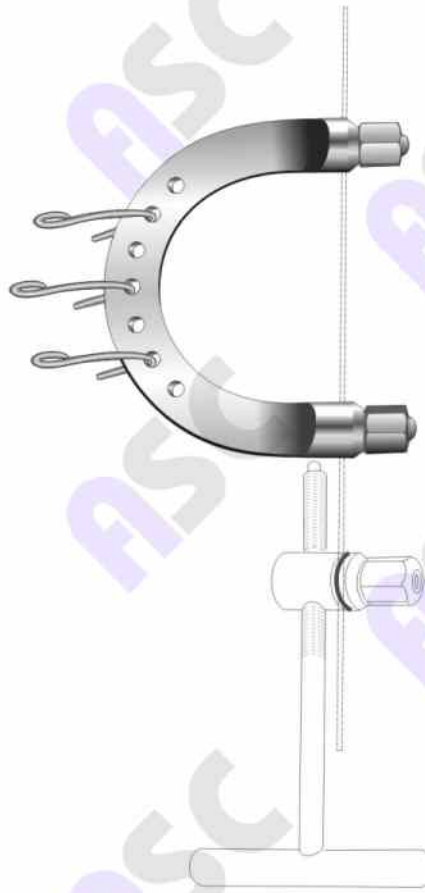

23-5885-00



23-5890-00

Kirschner

	H x B
23-5880-07	9.5 x 7.0 cm
23-5880-10	10.5 x 10.5 cm
23-5880-12	12.0 x 12.0 cm
23-5880-15	15.5 x 15.5 cm
23-5881-15	20.0 x 15.5 cm



- h x b
- 23-5895-10** 18 x 10 cm
- 23-5895-16** 27 x 16 cm

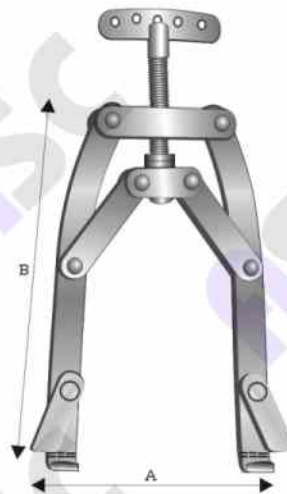

Kirschner U.S.

	A x B
23-5901-20 Small	100 13 x 20 cm
23-5902-27 Medium	150 20 x 27 cm
23-5903-00 Large	
23-5904-00 X-Large	



23-5905-00
Traction hooklet
for extension bows



23-5906-00
Traction hooklet
for extension bows

Bone Wire Guides, Graft Passer
Drahtumführungsnaedeln
Agujas pass hiles



23-5910-27
27.5 cm / 10 7/8"
Fig. 3

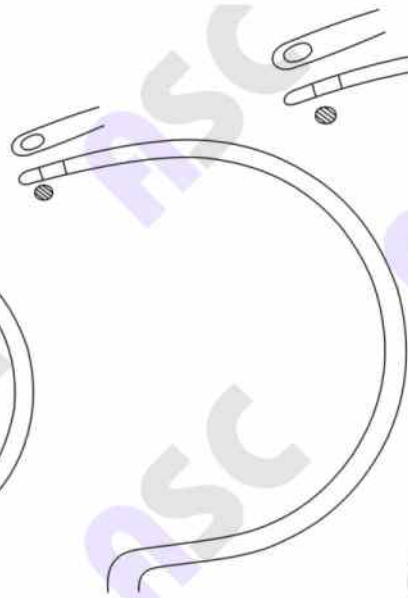

23-5910-28
28.5 cm / 11 1/4"
Fig. 2

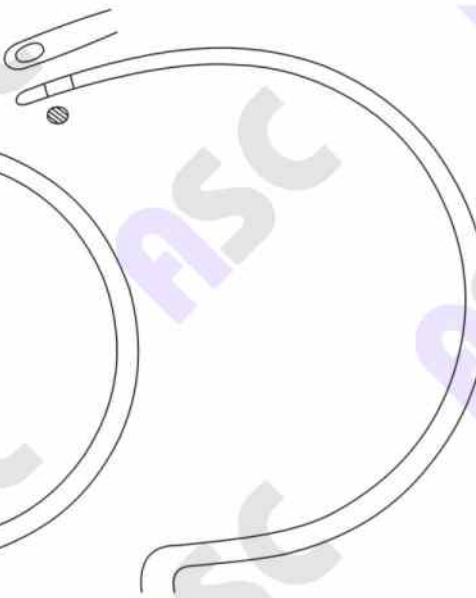

23-5910-30
30.5 cm / 12"
Fig. 1



23-5915-24
24 cm / 9 1/2"

23-5915-27
27 cm / 10 3/4"

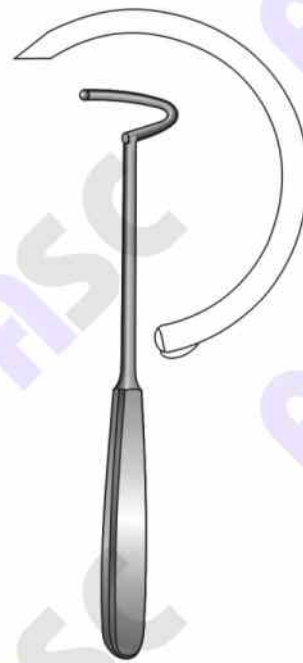

23-5920-22
22.5 cm / 9"



Graft Passer
23-5925-00
XL-Large
Curved
Slot cut into head

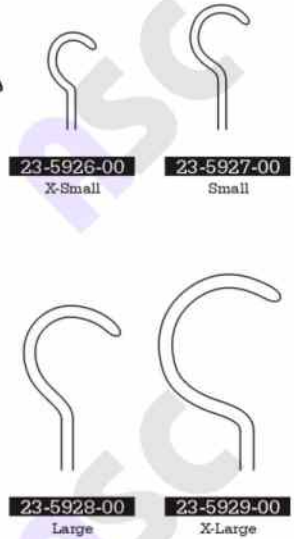

23-5926-00
X-Small

23-5927-00
Small

23-5928-00
Large

23-5929-00
X-Large



Demel
23-5930-28
28 cm / 11"



Loute
23-5935-21
21 cm / 8 1/4"



23-5940-00
Cerolage wire passer



23-5945-00
45 mm Ø



23-5950-00
70 mm Ø



Kuntscher
26 cm / 10 1/4"
23-5955-26 8 mm
23-5956-26 10 mm
23-5957-26 12.5 mm



Kuntscher
23-5960-35
35 cm / 14"



23-5965-00
23-5966-00



23-5970-29 29 cm / 11 1/4"
23-5970-37 37 cm / 14 1/4"
23-5970-42 42 cm / 16 1/4"
23-5970-49 49 cm / 19 1/4"

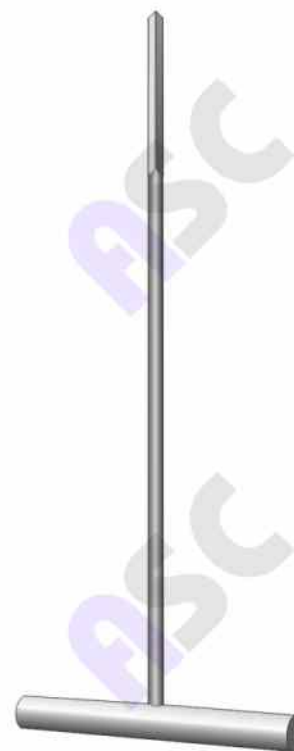

23-5975-00 2.4 mm Ø
23-5976-00 3.2 mm Ø
32-5977-00 4.8 mm Ø
23-5978-00 6.4 mm Ø

Bone Nailing Instruments
Knochen Nagel Instrumente
Instrumentos óseos para clavar



23-5980-00
2.4 mm Ø



23-5985-00
3.2 mm Ø



23-5990-00
4.8 mm Ø



23-5995-00
6.4 mm Ø



23-6001-00 2.4 mm Ø
23-6002-00 3.2 mm Ø
23-6003-00 4.8 mm Ø
23-6004-00 6.4 mm Ø



23-6005-21
21 cm / 8¼"



Kuentscher
23-6010-21
21 cm / 8¼"



Kuentscher
23-6015-21
21 cm / 8¼"



Kuentscher
23-6020-63
63 cm / 25¼"



23-6021-00



23-6022-00



23-6023-00



23-6024-00



23-6025-00

Bone Plate Benders
Plattenbiegeinstrumente
Instrumentos óseos para clavar

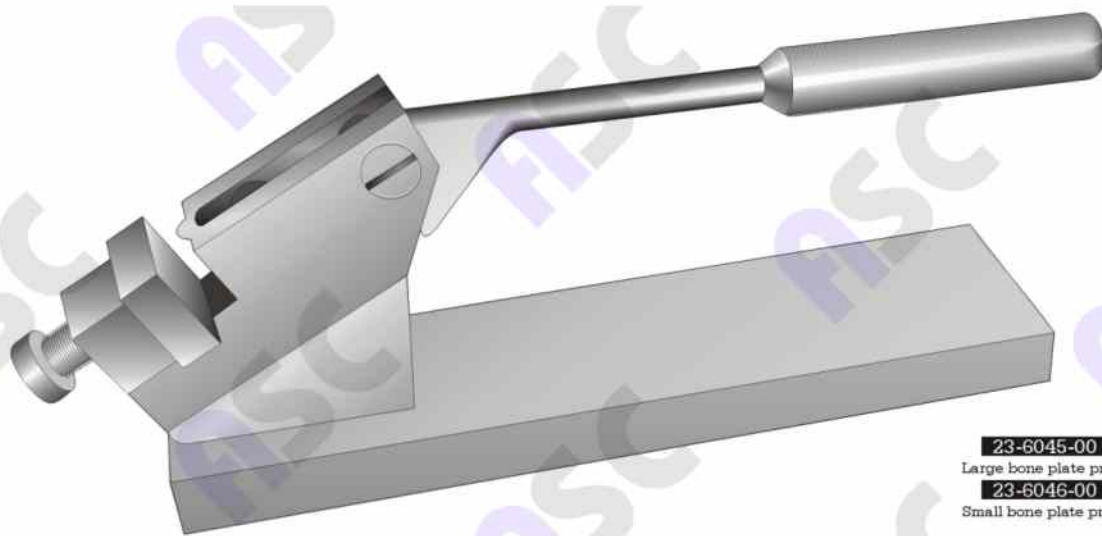

23-6045-00
Large bone plate press
23-6046-00
Small bone plate press



23-6050-22
22 cm / 8 3/4"

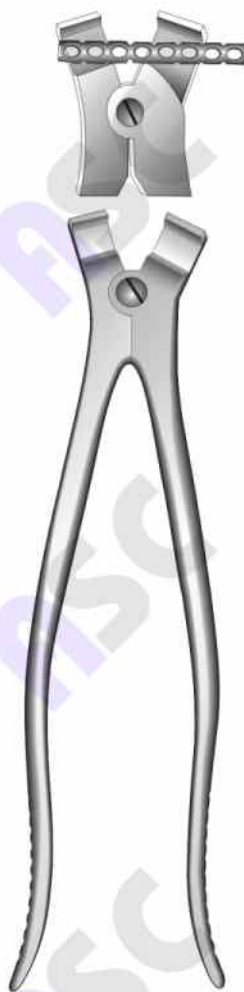

23-6060-00
Plate bending plier



23-6065-00
Plate bending plier

Craneal Rongeurs, Wire Saws
Schädelzangen, Drahtsägen
Pinzas sacabocados craneales, Sierras de hilo

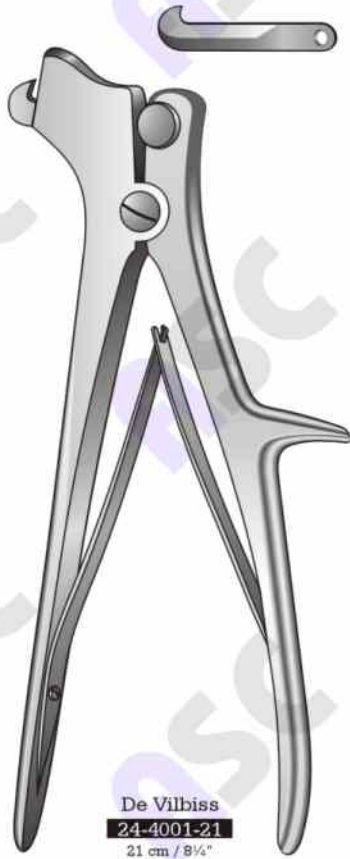

De Vilbiss
24-4001-21
21 cm / 8 1/4"

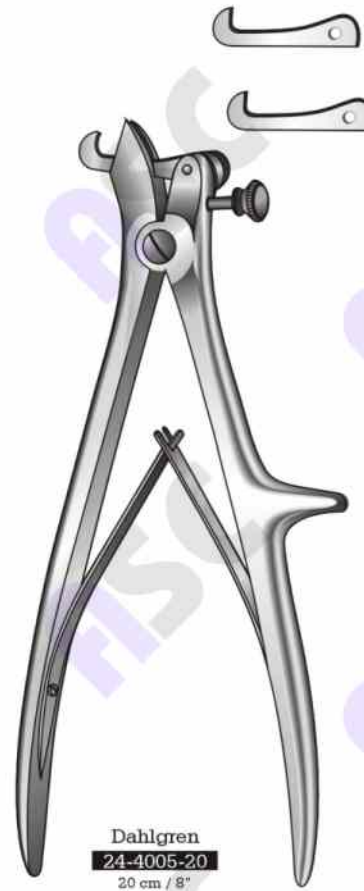

Dahlgren
24-4005-20
20 cm / 8"



Cone
24-4010-22
22.5 cm / 9"
Cranial punch



Martel
24-4015-33
33 cm / 13"
Saw guide, flexible

Skull Traction Tongs
Schädelhalter
Estribos de tracción craneal

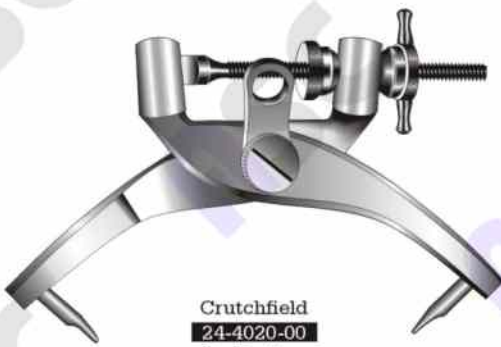

Crutchfield
24-4020-00
Small pattern



Crutchfield
24-4025-00
Medium pattern



24-4040-00 Small
24-4041-00 Large



24-4045-00
7 cm / 2 3/4"
3.5 mm Ø
Drill point



24-4046-00
7 cm / 2 3/4"
5 mm Ø
Drill point

Clip Applying Forceps
Clips Anlegezangen
Grapas pinzas aplicadoras



McKenzie
24-4050-15 15 cm / 6"
24-4050-19 19 cm / 7½"

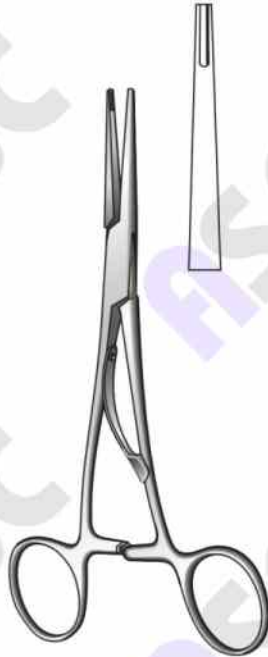

McKenzie
24-4055-15 15 cm / 6"
24-4055-19 19 cm / 7½"

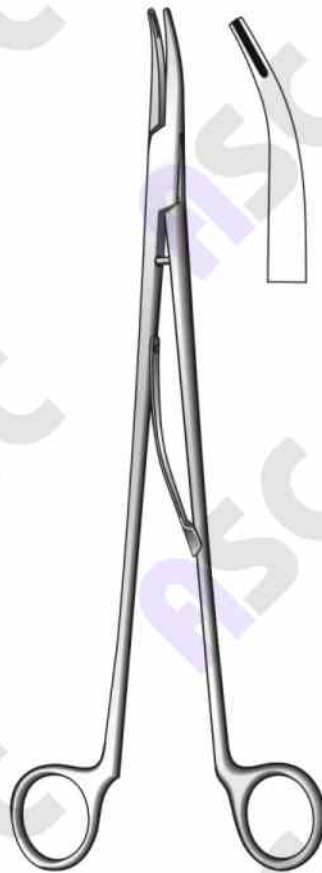

Smithwick
24-4060-23 23 cm / 9"
24-4060-26 26 cm / 10¼"

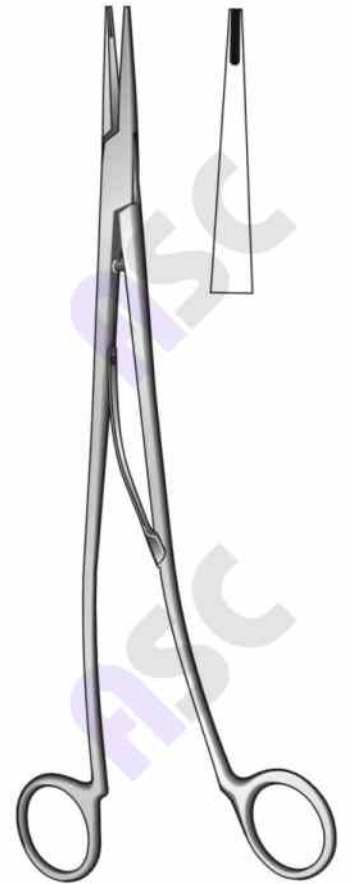

Sweet
24-4065-23 23 cm / 9"
24-4065-25 25 cm / 10"



Olivecrona Tbennis
24-4070-14
14 cm / 5½"

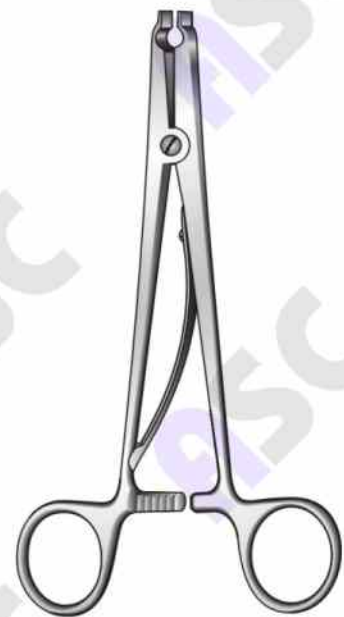

Raney
24-4075-16
16.5 cm / 6½"

Nerve Root Retractors, Brain Spatula
Nervwurzelnaken, Hirnspatel
Separadores para la raíz de nervio, Espátulas cerebrales



Love
24-4080-19
19 cm / 7 3/4"
Straight
Fig. 1



Love
24-4085-19
19 cm / 7 3/4"
Angled at 45°
Fig. 2



Love
24-4090-19
19 cm / 7 3/4"
Angled at 90°
Fig. 3



Cushing
24-4095-17 17 cm / 6 1/4"
24-4095-20 20 cm / 8"
24-4095-28 28 cm / 11 1/4"



Olivecrona
24-4101-18 7 x 9 mm
24-4102-18 11 x 13 mm
24-4103-18 15 x 18 mm
24-4104-18 18 x 22 mm
18 cm / 7"
Concave



Olivecrona
24-4105-18 7 x 9 mm
24-4106-18 11 x 13 mm
24-4107-18 15 x 18 mm
24-4108-18 18 x 22 mm
18 cm / 7"
Convex

Dura Dissectors, Nerve Root Retractors
Dura-Dissektoren, Nervwurzelnhaken
Descoladores de duramadre, Separadores para la raiz de nervio



Davis
24-4110-24
24.5 cm / 9 1/4"



Sachs
24-4115-21
21 cm / 8 1/4"

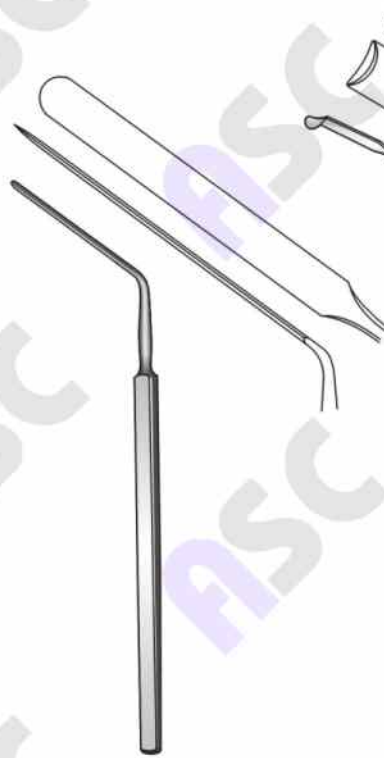

Horsley
24-4120-20
20 cm / 8"



Scoville
24-4125-20
20 cm / 8"

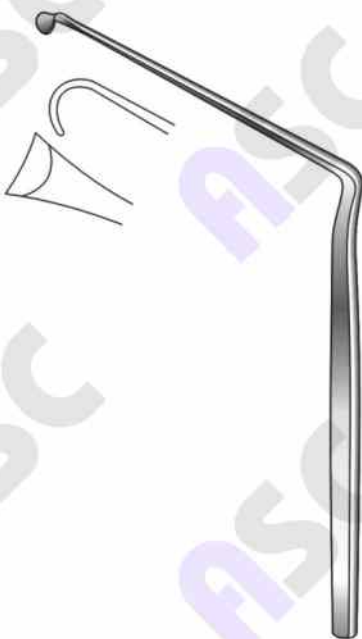

24-4130-21
21 cm / 8 1/4"



Scoville
24-4135-23
23 cm / 9"

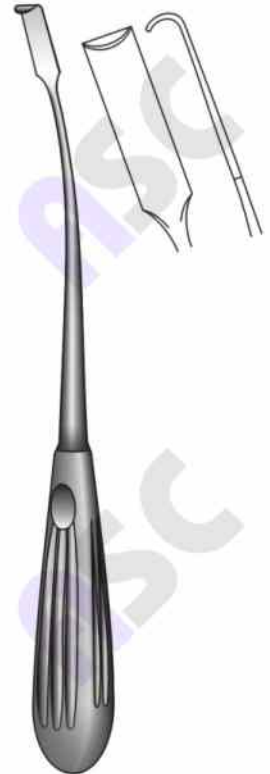

Holsher
24-4140-24
24 cm / 9 1/2"

Nerve Root Retractors
Nervwurzelnaken
Separadores para la raíz de nervio



Cushing
24-4145-21
21.5 cm / 8½"



Sachs
24-4150-21
21.5 cm / 8½"



Sachs
24-4155-21
21.5 cm / 8½"



Cushing
24-4160-23
23 cm / 9"



Sachs
24-4165-21
21.5 cm / 8½"

Nerve Hooks, Dura Hooks, Dissectors
Nerv-, Durahaken
Ganchos para nervios, Ganchos para duramadre



Cushing



Fig. 1

24-4185-19 19 cm / 7½"
24-4185-28 28 cm / 11"



Fig. 2

24-4186-19
24-4186-28



Dandy

24-4170-20
20 cm / 8"



Dandy

24-4175-20
20 cm / 8"



Dandy

24-4180-20
20 cm / 8"



Graham

24-4190-16
16.5 cm / 6½"
Elunt



Sachs

24-4195-18
18.5 cm / 7¼"
Sharp



Cushing

24-4201-14
14 cm / 5½"



Frazier

24-4205-13 13 cm / 5" 24-4206-13
24-4205-18 18 cm / 7" 24-4206-18
Sharp Elunt



Smithwick
24-4210-29
29 cm / 11½"



Adson
24-4215-20
20 cm / 8"
Sharp blade 5 mm at right angle



Olivecrona
24-4220-19 19.5 cm / 7¾"
24-4220-24 24 cm / 9½"



Olivecrona
24-4225-18 18 cm / 7"
24-4225-24 24 cm / 9½"

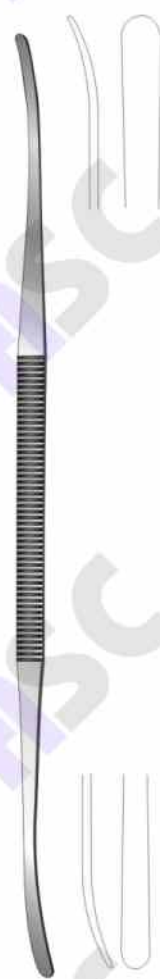

Toennis
24-4230-25
25 cm / 10"

Dura Dissectors
Dura-Dissektoren
Descoladores de duramadre



Milligan
24-4235-21
21 cm / 8¼"



24-4240-22
22 cm / 8¾"

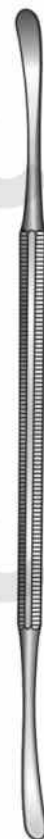

Sachs
24-4245-21
21 cm / 8¼"



Sachs
24-4250-21
21 cm / 8¼"



Penfield
24-4255-29
29 cm / 11½"



Penfield
24-4260-17
17.5 cm / 7"

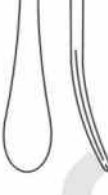

Penfield
24-4265-21
21.5 cm / 8½"



Dura Dissectors, Exploring Cannula, Suction tubes, Tampons Cannula
Dura-Dissektoren, Punktionskanülen, Saugkanülen, Tamponrohre
Descoladores de duramadre, Cánulas Ventriculares, Tubos de aspiración, cánula para tapones



Hoehn
24-4270-15
15 cm / 6"



Hoehn
24-4275-15
15 cm / 6"



Frazier
24-4280-15
15 cm / 6"



Frazier
24-4285-12
3 mm Ø
Silver plated
24-4286-12
2 mm Ø
Gold plated
12 cm / 4 3/4"



Seiffert
24-4290-12
12,5 cm / 5"



Elsberg
24-4295-11
11 cm / 4 3/4"
7 Fr. 2.3 mm, luer lock sterling,
3 hole closed end

Lamina Spreaders
Wirbelkörperspreizer
Separadores para cuerpos vertebrales



Inge
24-4301-24
24 cm / 9 1/2"



Inge
24-4310-16
16 cm / 6 1/4"



Inge
24-4305-27
27 cm / 10 3/4"

Lamina Spreaders, Wound Spreaders
Wirbelkörperspreizer, Wundspreizer
Separadores para cuerpos vertebrales, Separadores autostaticos

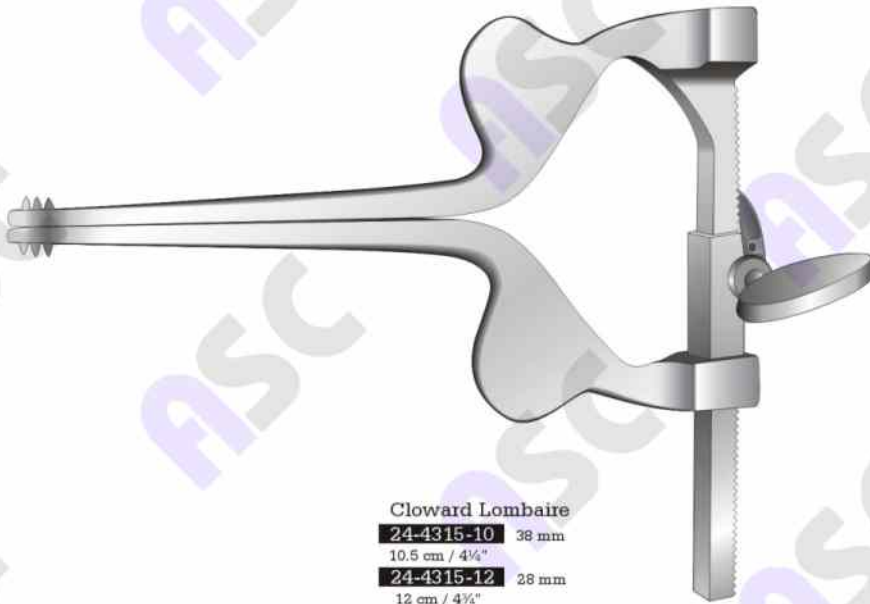

Cloward Lombaire
24-4315-10 38 mm
 10.5 cm / 4 1/4"
24-4315-12 28 mm
 12 cm / 4 3/4"



Cloward
24-4320-16 16 cm / 6 1/4"
24-4320-20 20 cm / 8"



Cloward
24-4325-16
 16 cm / 6 1/4"



Mathey
24-4330-18
 18 cm / 7"



Maurer
24-4335-20
 20 cm / 8"

Intervertebral Disc Rongeurs
Bandscheibenstanzen
Pinzas cortantes para discos intervertebrales

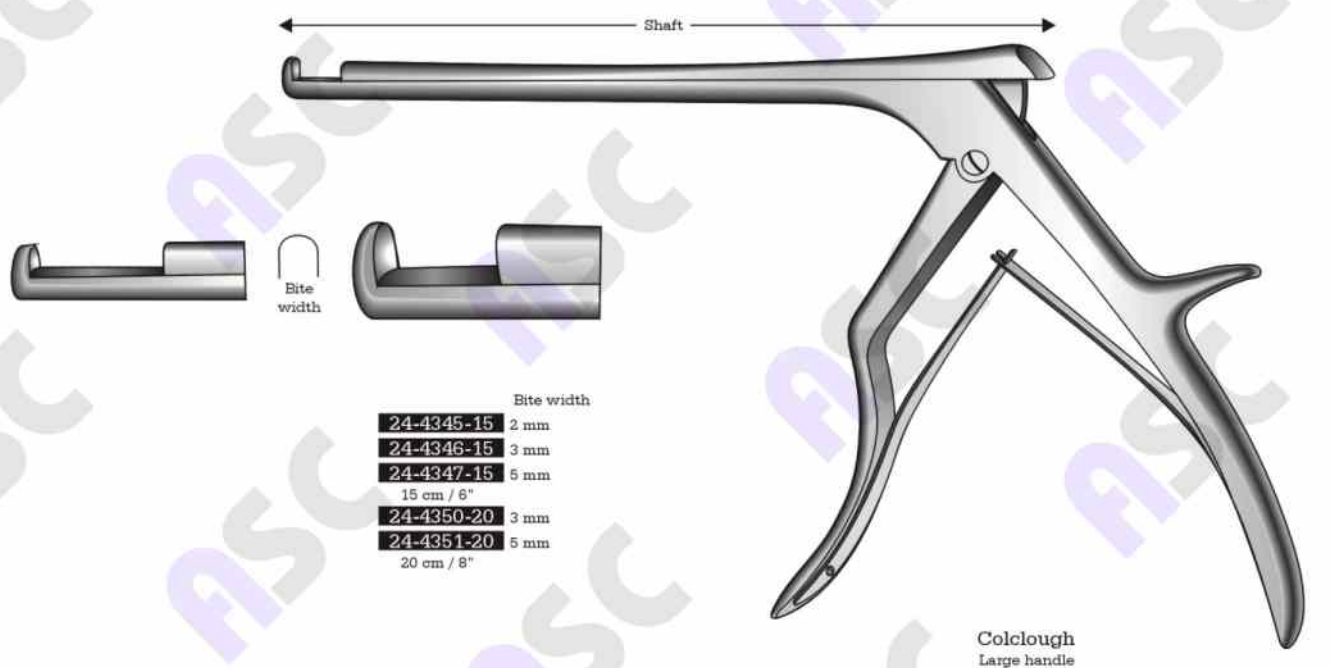

Intervertebral Disc Rongeurs
Bandscheibenstanzen
Pinzas cortantes para discos intervertebrales

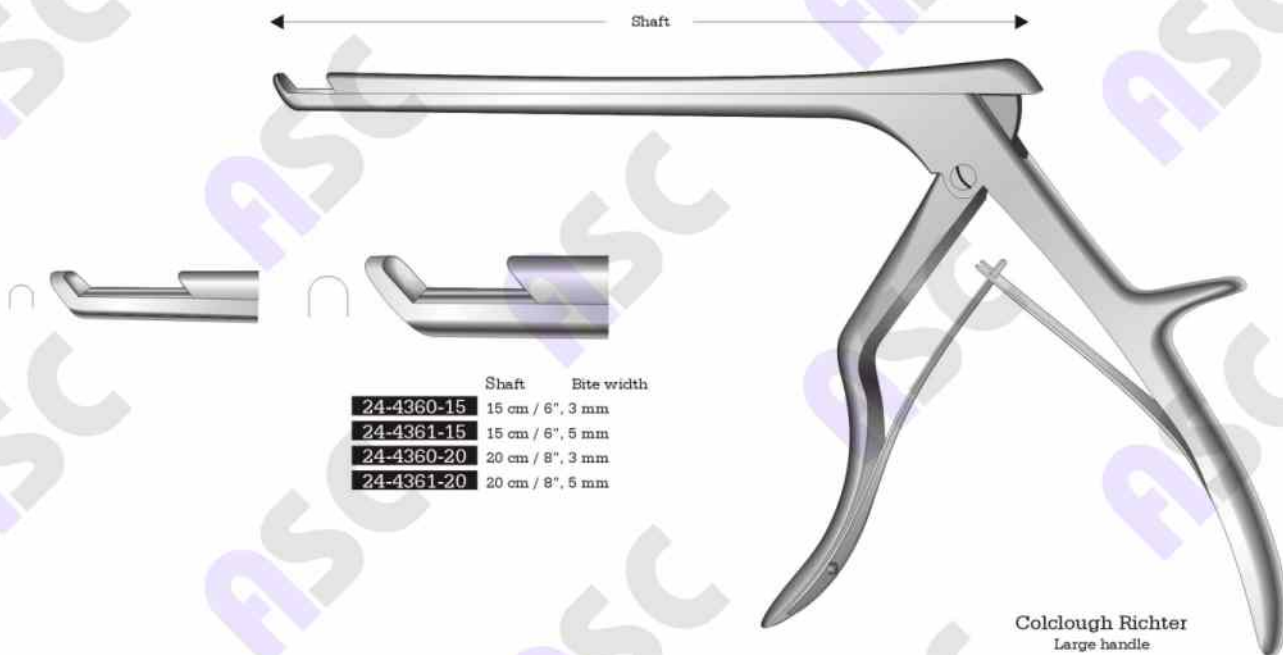
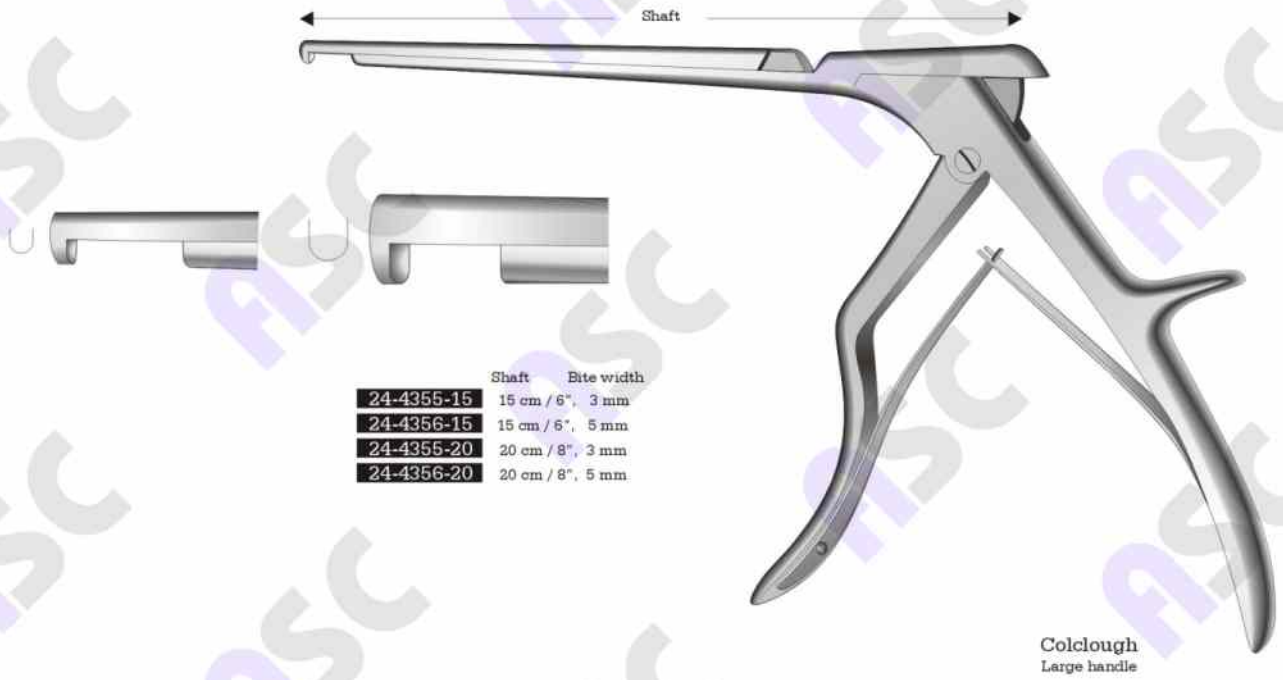

Intervertebral Disc Rongeurs
 Bandscheibenstanzen
 Pinzas cortantes para discos intervertebrales

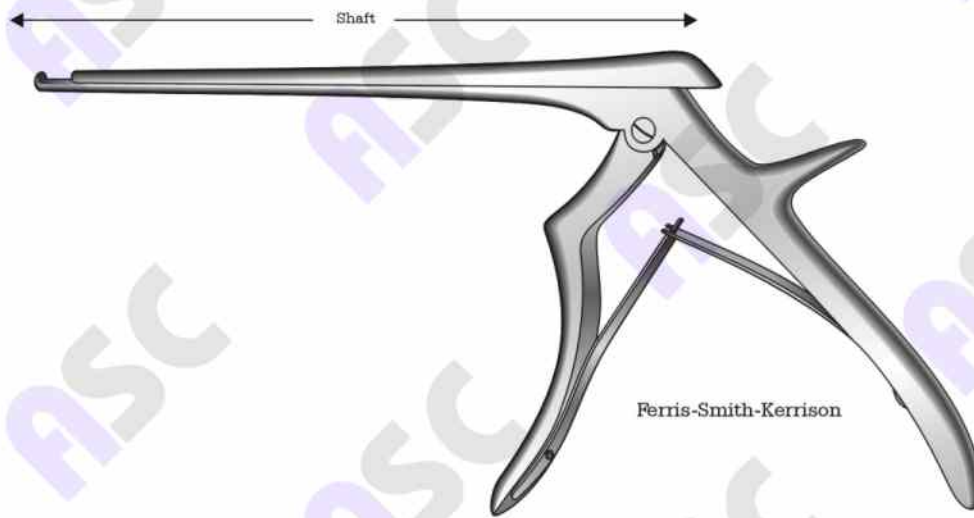

Ferris-Smith-Kerrison

Upward cutting	Downward cutting	Forward cutting
 24-4365-15 15 cm 24-4365-18 18 cm 24-4365-20 20 cm 1 mm	 24-4375-15 15 cm 24-4375-18 18 cm 24-4375-20 20 cm 1 mm	 24-4385-15 15 cm 24-4385-18 18 cm 24-4385-20 20 cm 1 mm
 24-4366-15 15 cm 24-4366-18 18 cm 24-4366-20 20 cm 2 mm	 24-4376-15 15 cm 24-4376-18 18 cm 24-4376-20 20 cm 2 mm	 24-4386-15 15 cm 24-4386-18 18 cm 24-4386-20 20 cm 2 mm
 24-4367-15 15 cm 24-4367-18 18 cm 24-4367-20 20 cm 3 mm	 24-4377-15 15 cm 24-4377-18 18 cm 24-4377-20 20 cm 3 mm	 24-4387-15 15 cm 24-4387-18 18 cm 24-4387-20 20 cm 3 mm
 24-4368-15 15 cm 24-4368-18 18 cm 24-4368-20 20 cm 4 mm	 24-4378-15 15 cm 24-4378-18 18 cm 24-4378-20 20 cm 4 mm	 24-4388-15 15 cm 24-4388-18 18 cm 24-4388-20 20 cm 4 mm
 24-4369-15 15 cm 24-4369-18 18 cm 24-4369-20 20 cm 5 mm	 24-4379-15 15 cm 24-4379-18 18 cm 24-4379-20 20 cm 5 mm	 24-4389-15 15 cm 24-4389-18 18 cm 24-4389-20 20 cm 5 mm
 24-4370-15 15 cm 24-4370-18 18 cm 24-4370-20 20 cm 6 mm	 24-4380-15 15 cm 24-4380-18 18 cm 24-4380-20 20 cm 6 mm	 24-4390-15 15 cm 24-4390-18 18 cm 24-4390-20 20 cm 6 mm

Intervertebral Disc Rongeurs
Bandscheibenstanzen
Pinzas cortantes para discos intervertebrales

Open shaft

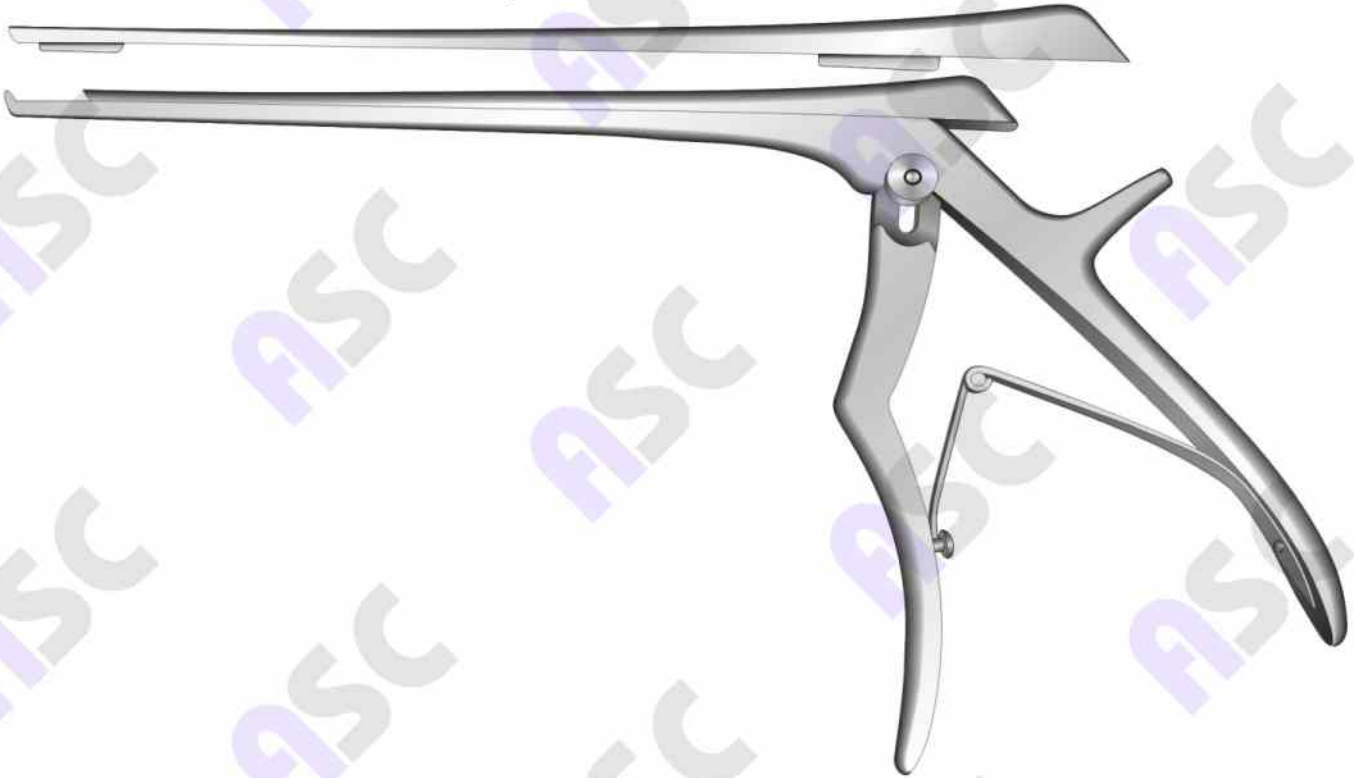

Upward cutting

Downward cutting

Forward cutting

	24-4415-15 15 cm
	24-4415-18 18 cm
	24-4415-20 20 cm
	1 mm
	24-4416-15 15 cm
	24-4416-18 18 cm
	24-4416-20 20 cm
	2 mm
	24-4417-15 15 cm
	24-4417-18 18 cm
	24-4417-20 20 cm
	3 mm
	24-4418-15 15 cm
	24-4418-18 18 cm
	24-4418-20 20 cm
	4 mm
	24-4419-15 15 cm
	24-4419-18 18 cm
	24-4419-20 20 cm
	5 mm
	24-4420-15 15 cm
	24-4420-18 18 cm
	24-4420-20 20 cm
	6 mm

	24-4425-15 15 cm
	24-4425-18 18 cm
	24-4425-20 20 cm
	1 mm
	24-4426-15 15 cm
	24-4426-18 18 cm
	24-4426-20 20 cm
	2 mm
	24-4427-15 15 cm
	24-4427-18 18 cm
	24-4427-20 20 cm
	3 mm
	24-4428-15 15 cm
	24-4428-18 18 cm
	24-4428-20 20 cm
	4 mm
	24-4429-15 15 cm
	24-4429-18 18 cm
	24-4429-20 20 cm
	5 mm
	24-4430-15 15 cm
	24-4430-18 18 cm
	24-4430-20 20 cm
	6 mm

	24-4435-15 15 cm
	24-4435-18 18 cm
	24-4435-20 20 cm
	1 mm
	24-4436-15 15 cm
	24-4436-18 18 cm
	24-4436-20 20 cm
	2 mm
	24-4437-15 15 cm
	24-4437-18 18 cm
	24-4437-20 20 cm
	3 mm
	24-4438-15 15 cm
	24-4438-18 18 cm
	24-4438-20 20 cm
	4 mm
	24-4439-15 15 cm
	24-4439-18 18 cm
	24-4439-20 20 cm
	5 mm
	24-4440-15 15 cm
	24-4440-18 18 cm
	24-4440-20 20 cm
	6 mm

Laminectomy Rongeurs
 Laminektomie Zangen
 Pinzas cortantes para laminectomia

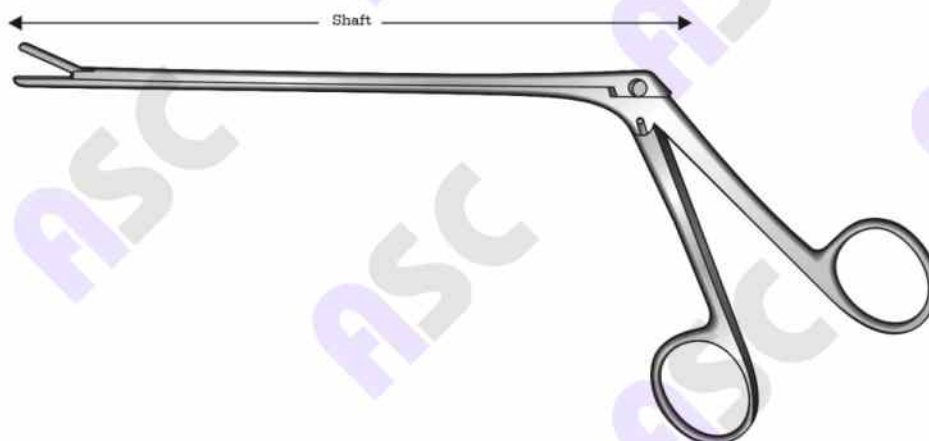

Spurling
24-4445-12 12 cm
24-4445-15 15 cm
24-4445-18 18 cm
 4 x 10 mm
 Straight

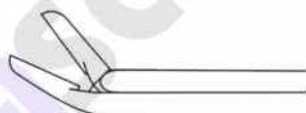

Spurling
24-4450-12 12 cm
24-4450-15 15 cm
24-4450-18 18 cm
 4 x 10 mm
 Angled at 45°
 Upward

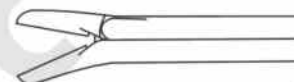

Spurling
24-4455-12 12 cm
24-4455-15 15 cm
24-4455-18 18 cm
 4 x 10 mm
 Angled at 45°
 Downward



Love Gruenwald
24-4460-12 12 cm
24-4460-15 15 cm
24-4460-18 18 cm
 3 x 10 mm
 Straight



Love Gruenwald
24-4465-12 12 cm
24-4465-15 15 cm
24-4465-18 18 cm
 3 x 10 mm
 Angled at 45°
 Upward

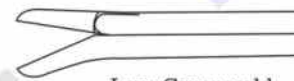

Love Gruenwald
24-4470-12 12 cm
24-4470-15 15 cm
24-4470-18 18 cm
 3 x 10 mm
 Angled at 45°
 Downward

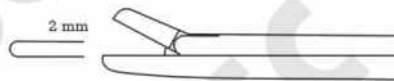

Cushing
24-4475-12 12 cm
24-4475-15 15 cm
24-4475-18 18 cm
 2 x 10 mm
 Straight



Cushing
24-4480-12 12 cm
24-4480-15 15 cm
24-4480-18 18 cm
 2 x 10 mm
 Angled at 45°
 Upward



Cushing
24-4485-12 12 cm
24-4485-15 15 cm
24-4485-18 18 cm
 2 x 10 mm
 Angled at 45°
 Downward

Laminectomy Rongeurs
Laminektomie Zangen
Pinzas cortantes para laminectomia

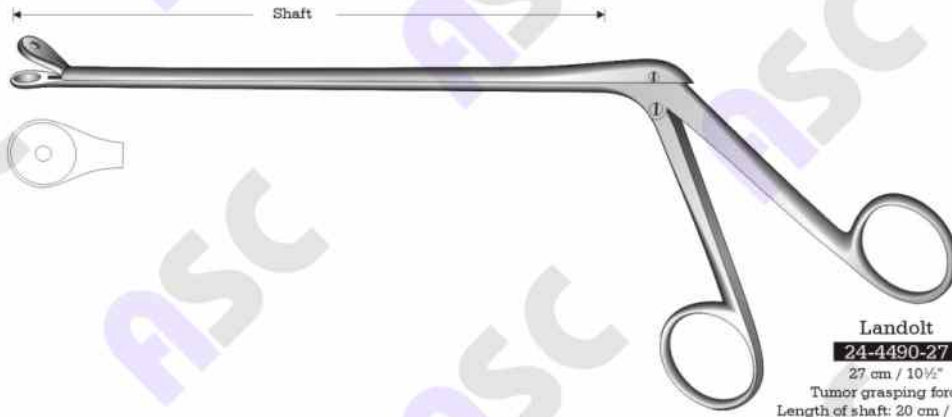

Landolt
24-4490-27
27 cm / 10½"
Tumor grasping forceps
Length of shaft: 20 cm / 8", blunt

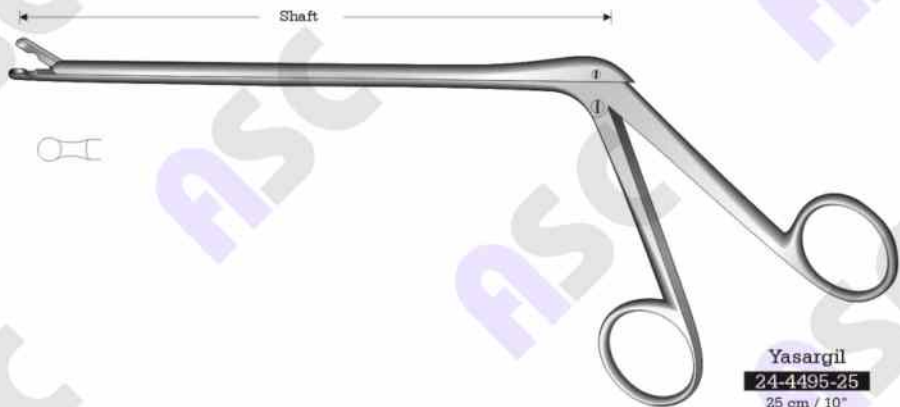

Yasargil
24-4495-25
25 cm / 10"
Pituitary rongeur
Length of shaft: 18 cm / 7", sharp



Oldberg
24-4501-25
25 cm / 10"
Length of shaft: 18 cm / 7"



Alphabetical Index



Alphabetical Index

ADSON Bone Drills Guide	17	Chisel, Fishtail	34
ADSON Dissectors	129	Chisels	32-38, 40, 41, 45, 46, 48, 51
ADSON Elevators	53	Chucks and Keys	22, 23, 109
ALEXANDER Bone Chisels	33	Chucks, Drill	109
ALEXANDER Bone Gouges	33	Clamps, Bone Holding	71, 73, 75, 77, 79, 81-83
ALEXANDER Bone Rongeur Forceps	90	CLEVELAND Bone Cutting Forceps	99, 100
ALEXANDER Elevators	54	CLEVELAND Bone Rongeur Forceps	87,88
Amputating Saws	18	Clip Applying Forceps	124
Amputation Saws	19	CLOWARD LOMBAIRE Lamina Spreaders	133
Arthroplasty Excision	14	CLOWARD Wound Spreaders	133
AUFRICHT Nasal Rasps	14	COBB Bone Curettes	31
Bandage Scissors	2, 3	COBB Gouges	42
BAUMGARTNER Wire Twister, Ligature Forceps	105	COBB Spinal Elevator & Gouge	45
BEESON Plaster Cast Spreaders	5	COLBURN-MILLER Bone Files	15,16
Benders, Bone Plate	121	COLCLOUGH Intervertebral Disc Rongeurs	134, 135
Bending Plier for Plates	121	COLCLOUGH-RICHTER Intervertebral Disc Rongeurs	135
BENNETT Bone Retractors	62	COLLIN Mallets	7
BERGMANN Mallets	9	COMBINATION MALLET Mallets	8
BEYER Bone Rongeur Forceps	90, 93	CONE Craneal Punch	122
BIER Resection Saws	19	Conical Burr	20
BIRCHER Meniscotomy Knives	63	COTTLE Bone Osteotomes & Chisels	34
BIRCHER-GANSKE Bone Holding Forceps	70	COTTLE Mallets	8
BISHOP Bone Holding Forceps	76	COTTLE Rasp	15
Blades, Chisel & Gouge	51	COUPE CLAMP Nail Instruments	26
BLOUNT Bone Levers	62	Craneal Rongeurs	122
BLUMENTHAL Bone Rongeur Forceps	89	Cranial Punch	122
BOHLER Bone Cutting Forceps	100, 101	CROWN Wire Twisting Forceps	104
BOHLER Bone Rongeur Forceps	92	CRUTCHFIELD Skull Traction Tongs	123
Bone Chisels	32-38, 45, 46, 48	Curettes, Bone	27-31
Bone Clamp	83	CUSHING Brain Spatula	125
Bone Curettes	27-31	CUSHING Hooks	128
Bone Cutting Forceps	4, 99-103	CUSHING Laminectomy Rongeurs	138
Bone Drills	17	CUSHING Nerve Root Retractors	127
Bone Files	11-16	CUSHING Periosteal Elevators	57
Bone Fragment Forceps	68	Cutters, Head	114
Bone Gouges	32-38, 45, 46, 48	Cutters, Pin, Double Action	116
Bone Holding Clamps	71, 73, 75, 77, 79, 81-83	Cutters, Shear	106
Bone Holding Forceps	67-72, 74, 76-78, 80	Cutters, Spare Blade	26
Bone Hooks	52	Cutters, Wire	114
Bone Levers	13, 59-62	Cutting Forceps, Bone	4, 99-103
Bone Nailing	119	Cutting Forceps, Plate	116
Bone Nailing Instruments	120	Cutting Pliers, Wire	106, 108, 110, 112-116
Bone Osteotomes	32-38, 46, 48	CYLINDRIQUES Bone Files	11
Bone Plate Benders	121	DAHLGREN Craneal Rongeurs	122
Bone Reduction Forceps	67-70, 72, 74, 76, 78, 80	DALE Bone Rongeur Forceps	98
Bone Reposition Forceps	68	DANDY Hooks	128
Bone Rongeur Forceps	86-98	DAVIS Dura Dissectors	126
Bone Skid	13	DE VILBISS Craneal Rongeurs	122
Bone Wire Guides	118	DEMEL Bone Wire Tighteners	119
Bone Wire Tighteners	119	DIAMANT Wire Cutting Pliers	112
Bows, Extension	117	DINGMANN Bone Holding Forceps	70
Brain Spatula	125	Disc Rongeurs	134-137
BRAND Tendon Seizing Instruments	65	Dissectors	128, 129
Breaker, Pediatric Cast	6	Dissectors, Dura	126, 130, 131
Breaker, Skull	45	Double Action Pin Cutter	116
BRECK-LOWE Meniscotomy Knives	64	DOWNING Meniscotomy Knives	64
BRUN Bone Curettes	31	DOYEN Mallets	7
BRUNETTI Bone Chisels	45	DOYEN Periosteal Elevators	55
BRUNS Bandage Scissors	2	Drill Chucks	109
BRUNS Bone Curettes	28	Drill Guide	110
BUCK-GRAMCKO Bone Levers	59	Drill, Twist	21
BUNNELL Hand Drills	23	Drills, Bone	17
Burr for Hand Drill	20	Drills, Hand	20-23
BUTCHER Resection Saws	19	Drivers, Screw	24
Cannula, Exploring	131	Dura Dissectors	126, 130, 131
Cannula, Tampons	131	Dura Hooks	128, 129
Cast Breaker, Pediatric	6	EAST GRINSTEAD (WARD) Bone Chisels & Osteotomes	34
Cast Spreaders, Plaster	5	EASTMANN Bone Chisels	34
CAUCHOIX Osteotomes	44	ECHLIN Bone Rongeur Forceps	95
Cerclage Wire Twister	109	Elevator, Spinal	45
CHARRIERE Resection Saws	18	Elevators	53
Chisel Blades & Handles	51	ELSBERG Tampons Cannula	131

Alphabetical Index

ENGEL Amputating Handles	18	Handles, Saws	18
ESMARCH Plaster of Paris Knives	1	HARTMANN Bone Rongeur Forceps	88
EXCENTRIC Bandage Scissors	3	HAUTANT Chisels	40
Exploring Cannula	131	HAUTSNT Gouges	42
Extension Bows	117	Head Cutter	114
Extension Piece	20	HEATH Mallets	8
Extracting Forceps, Nail	26	HENNIG Plaster Cast Spreaders	5
FARABEUF Bone Holding Forceps	80	HEXAGON Screw Drivers	24
FARABEUF Osteotome & Chisels	40,44	HEY GROVES Bone Holding Forceps	74
FARABEUF Periosteal Elevators	56	HIBBS-HILDER Bone Osteotomes & Chisels	38
FARABEUF-LAMBOTTE Bone Holding Forceps	80	HILDER Gouges	39
FERGUSSON Bone Holding Forceps	71	HILDER-HIBBS Bone Osteotomes & Chisels	38
Files, Bone	11-16	HOEN Dura Dissectors	131
Finger Ring Saws	26	HOEN Periosteal Elevators	57
Fishtail Chisel	34	HOHMANN Bone Levers	59-61
Flat Nose Pliers	105-108	HOHMANN-LANGE Bone Levers	61
Flat Trepphine	20	HOHMANN-Mini Bone Levers	59
Forceps, Bone Cutting	4, 99-103	Holding Forceps, Bone	67-83,105
Forceps, Bone Fragment	68	HOLSHER Nerve Root Retractors	126
Forceps, Bone Holding	67-70, 72, 74, 76, 78, 80	HONTON Gouges	42
Forceps, Bone Reduction	67-70, 72, 74, 76, 78, 80	Hooklet, Traction	117
Forceps, Bone Reposition	68	Hooks, Bone	52
Forceps, Bone Rongeur	86-98	Hooks, Dura	128, 129
Forceps, Clip Applying	124	Hooks, Nerve	128, 129
Forceps, Holding	105	HOPKINS Plaster of Paris Knives	1
Forceps, Ligature	105	HORSLEY Dura Dissectors	126
Forceps, Nail Extracting	26	HUDSON Hand Drills	20
Forceps, Pelvic Reposition	84, 85	HUDSON Trepphines	110
Forceps, Reposition	66, 69	INGE Lamina Spreaders	132
Forceps, Tumor Grasping	139	Intervertebral Disc Rongeurs	134-137
Forceps, Wire Pulling	108	JACOBS Chuck	23
Forceps, Wire Twisting	104, 111	JACOBS Chuck's Keys	23, 109
FORMAN Rasp	13	JACOBS Drill Chucks	109
FORSCH Bone Holding Forceps	71	JANSEN Bone Rongeur Forceps	88, 90
FRAZIER Exploring Cannula	131	JANSEN-ZAUFAL Bone Rongeur Forceps	93
FRAZIER Hooks	128	Jet Wire Twister	104
FREER Bone Levers	59	JOSEPH Bone Files	14
FRERRIS-SMITH-KERRISON Intervertebral Disc Rongeurs	136	JUDET Chisels	40
FRIEDMAN Bone Rongeur Forceps	86	JUERS-LEMPERT Bone Rongeur Forceps	92
FRIEDMAN-Micro Bone Rongeur Forceps	86	KAZANJIAN Bone Cutting Forceps	100
FRIEDMAN-Mini Bone Rongeur Forceps	86	KERN Bone Holding Forceps	72
FRYKHOLM Bone Rongeur Forceps	95	KERRISON-FRERRIS-SMITH Intervertebral Disc Rongeurs	136
GANSKE-BIRCHER Bone Holding Forceps	70	Key for Jacobs Chuck	23
GERSTER Traction Bar	82	KEY Periosteal Elevator	36
GERSTER-LOWMANN Bone Holding Clamps	82	KEY-LISTON Bone Cutting Forceps	103
GERZOG Mallets	9	Keys and Chucks	22, 23, 109
GIGLI Amputating Handles	18	KIENNY Bone Files	11
GIGLI Wire Saws	17	KIRK Mallets	9
GILLIES Bone Osteotomes	32	KIRSCHNER Extension Bows	117
Gouge Blades, Interchangeable	51	KIRSCHNER U.S. Extension Bows	117
Gouge, Spongiosa	47, 49, 50	KLEINERT-KUTZ Bone Rongeur Forceps	94
Gouges	32-39, 40, 42-46, 48, 50	Knives, Meniscotomy	63, 64
Graft Passer	118	Knives, Plaster of Paris	1
GRAHAM Dissectors	128	KONIG Periosteal Elevators	55
GRAMCKO-BUCK Bone Levers	59	KUENTSCHER Bone Nailing Instruments	120
Grasping Forceps	134	KUENTSCHER Wire Passers and Bone Nailing	119
Grasping Forceps, Tumor	139	KUTZ-KLEINERT Bone Rongeur Forceps	94
Guide, Drill	110	LAMBOTT Periosteal Elevators	55
Guide, Saw	122	LAMBOTTE Bone Holding Forceps	81
Guides, Bone Wire	118	LAMBOTTE Bone Osteotomes	35
GUILLAUME Gouges	42	LAMBOTTE-FARABEUF Bone Holding Forceps	80
GULEKE Bone Rongeur Forceps	90	LAMBOTTE-Mini Bone Osteotomes	35
HAASE Bone Holding Forceps	66	LAMINA Spongiosa Gouges	49
HAGLUND Plaster Cast Spreaders	5	Lamina Spreaders	132, 133
HAKANSSON Bone Rongeur Forceps	90	Laminectomy Rongeur	94, 138, 139
HAKSTOCK Nose Pliers	106	LANDOLT Laminectomy Rongeurs	139
HALLE Bone Curettes	30	LANE Bone Holding Forceps	73
Hammers	7-10	LANE Screw Drivers	24
Hand Drills	20-23	LANE-MURPHY Bone Levers	13
Hand, Lead	25	LANGE-HOHMANN Bone Levers	61
Handle with Chuck and Key	22	LANGENBECK Bone Holding Forceps	71
Handles, Chisel	51	LANGENBECK Periosteal Elevators	53, 56, 57

LANGENBECK Resection Saws	18	Nailing Instruments, Bone	119, 120
LAUCAS CHAMPIONNIERE Chisels	41	Nasal Rasps	14
Lead Hand	25	Needle Nose Plier	111, 107, 108
LEBSCHKE Bone Chisels	45	NEFF Meniscotomy Knives	64
LEKSELL Bone Rongeur Forceps	96	Nerve Hooks	128, 129
LEKSELL-STILLE Bone Rongeur Forceps	96	Nerve Root Retractors	125-127
LEMPERT Bone Rongeur Forceps	92	NORTHEILD Bone Rongeur Forceps	91
LEMPERT-JUERS Bone Rongeur Forceps	92	Nose Locking Plier, Needle	111
LETOURNE Gouge	40	Nose Pliers	107, 108
Levers, Bone	13, 59-62	Nose Pliers, Flat	105, 106
LEWIN Bone Holding Forceps	70	OLDBERG Laminectomy Rongeurs	139
LEWIS Rasp	15	OLIVECRONA Bone Rongeur Forceps	90
LEXER Bone Chisels & Gouges	46, 48	OLIVECRONA Brain Spatula	125
LEXER Spongiosa Gouges	47, 50	OLIVECRONA Dura Dissectors	129
LEXER-Mini Bone Osteotomes & Gouges	46	OLIVECRONA TOENNIS Clip Applying Forceps	124
Ligature Forceps	105	OLIVECRONA Wire Saws	17
LINDEMANN Amputating Saws	18	OLLIER Bone Holding Forceps	77
LISTON Bone Cutting Forceps	99, 101, 103	OMBEREDANNE Chisels	41
LISTON-KEY Bone Cutting Forceps	103	OMBREDANNE Mallets	9
LISTON-RUSKIN Bone Cutting Forceps	101	Osteotomes	32-38, 40, 44, 46, 48
LISTON-STILLE Bone Cutting Forceps	102	PARTSCH Bone Chisels & Gouges	32, 33
LOCKE Bone Holding Forceps	69	PARTSCH Chisels	41
Locking Plier	111	PARTSCH Mallets	8
Locking Plier, Needle Nose	111	Passer, Graft	118
LORENZ Bandage Scissors	3	Passer, Wire	119
LOUTE Bone Wire Tighteners	119	Patella Forceps	77
LOVE GRUENWALD Laminectomy Rongeurs	138	Pediatric Cast Breaker	6
LOVE Nerve Root Retractors	125	Pelvic Reposition Forceps	84, 85
LOWE-BRECK Meniscotomy Knives	64	PENFIELD Dura Dissectors	130
LOWMAN HOGLUND Bone Holding Clamps	83	PENNER Nail Instruments	26
LOWMANN Bone Holding Clamps	83	PENNYBACKER Bone Rongeur Forceps	91
LOWMANN-GERSTER Bone Holding Clamps	82	PERCY Retractor	19
LUCAE Mallets	7	Periosteal Elevators	36, 55-58
LUCAS Bone Osteotomes & Gouges	34	Periosteal Raspatories	54
LUER Bone Rongeur Forceps	89	PERTHES Reamers	17
LUER-STILLE Bone Rongeur Forceps	97	PETERSON-SMITH Bone Osteotomes Chisels, Gouges	37, 44
MACEVEN Chisels	41	PETERSON-SMITH Bone Rongeur Forceps	94
MALLEOLLAR Bone Holding Forceps	69	Pin Chuck Hand Drills	22
Mallets	7-10	Pin Cutter, Double Action	116
MALTZ IMPROVED Nasal Rasps	14	Pin Pulling Plier	107
MALTZ Nasal Rasps	14	Pituitary Rongeur	139
MANTE Chisels	41	Plaster Cast Spreaders	5
MARCHAC Bone Rongeur Forceps	89	Plaster of Paris Knives	1
MARKWALDER Bone Cutting Forceps	99, 100	Plaster of Paris Shears	6
MARQUARDT Bone Rongeur Forceps	94	Plate Benders, Bone	121
MARTEL Wire Saw Guide	122	Plate Bending Plier	121
MARTINI Bone Curettes	27	Plate Cutting Plier	116
MASSON Plaster of Paris Shears	6	Pliers, Flat Nose	105-108
MATHEY Wound Spreaders	133	Pliers, Locking	111
MATSON Elevators	54	Pliers, Needle Nose	107, 108, 111
MAURER Wound Spreaders	133	Pliers, Pin Pulling	107
MAYFIELD Bone Rongeur Forceps	93	Pliers, Plate Bending	121
MC INDOE Bone Cutting Forceps	101	Pliers, Plate Cutting	116
MCKENZIE Clip Applying Forceps	124	Pliers, Wire Cutting	106, 108, 110, 112-116
MEAD Bone Rongeur Forceps	87	Pliers, Wire Tightening	105
MEAD Mallets	8	Pliers, Wire Twister	110
Meniscotomy Knives	63, 64	Pliers, Wire Twisting	107, 108
MEYER Bone Holding Forceps	69	POIRIER Chisels	41
MICHELE Trephines	110	POIRIER Gouges	43
Micro-FRIEDMAN Bone Rongeur Forceps	86	POIRIER-TRILLAT Gouges	43
MILLER-COLBURN Bone Files	15, 16	POLOKOFF Rasp	15
MILLIGAN Dura Dissectors	130	PORTMANN Chisels	41
Mini-FRIEDMAN Bone Rongeur Forceps	86	Post Mortem Saw	19
Mini-HOHMANN Bone Levers	59	POSTEL Gouges	43
Mini-LAMBOTTE Bone Osteotomes	35	Pulling Forceps, Wire	108
Mini-LEXER Bone Osteotomes & Gouges	46	Pulling Plier, Pin	107
Mini-STILLE Plaster of Paris Shears	6	Punch, Cranial	122
MOD. USA Bone Curettes	30	PUTTI Bone Files	13
MOORE Hand Drills	22	PUTTI Gouges	43
MURPHY-LANE Bone Levers	13	QUISLING Mallets	9
Nail Extracting Forceps	26	RADOLF Nail Instruments	26
Nail Instruments	26	RALK Hand Drills	23

Alphabetical Index

RANEY Clip Applying Forceps	124	SPRATT Bone Curettes	28
Rasps, Nasal	14	Spreaders, Lamina	132, 133
Rat Tooth Rongeur	92	Spreaders, Plaster Cast	5
Reamers	17	Spreaders, Wound	133
Reduction Forceps, Bone	67-70, 72, 74, 76, 78, 80	SPURLING Laminectomy Rongeurs	138
REILL Bone Holding Forceps	68	STAGBEELE Bone Holding Forceps	67
REINER Plaster of Paris Knives	1	STAMM Bone Cutting Forceps	100
Reposition Forceps	66, 68, 69	STEINHAUSER Bone Holding Forceps	68
Reposition Forceps, Pelvic	84, 85	STEINMANN Tendon Seizing Instruments	65
REQUESTRUM Bone Holding Forceps	71	STELLBRINK Bone Rongeur Forceps	87
Resection Saws	18, 19	STILLE Bone Osteotomes, Chisels & Gouges	36
Retractor	19, 125-127	STILLE Bone Rongeur Forceps	95
RICHTER-COLCLOUGH Intervertebral Disc Rongeurs	135	STILLE Hand Drills	21
Ring Cutter	26	STILLE Plaster of Paris Shears	6
Ring Saws, Finger	26	STILLE-LEKSELL Bone Rongeur Forceps	96
ROBIN Osteotomes	44	STILLE-LISTON Bone Cutting Forceps	102
Rongeur Forceps, Bone	86-98	STILLE-LUER Bone Rongeur Forceps	97
Rongeur, Craneal	122	STILLE-Mini Plaster of Paris Shears	6
Rongeur, Disc	134-137	STILLE-RUSKIN Bone Rongeur Forceps	95
Rongeur, Laminectomy	94, 138, 139	STILLE-SHERMAN Hand Drills	21
Rongeur, Pituitary	139	STRAGNARA Gouges	44
Rongeur, Synovectomy	94	Suction Tubes	131
Root Retractors, Nerve	125-127	SWEET Clip Applying Forceps	124
RUSKIN Bone Rongeur Forceps	93,94	Synovectomy Rongeur	94
RUSKIN-LISTON Bone Cutting Forceps	101	SYPERT Bone Rongeur Forceps	98
RUSKIN-STILLE Bone Rongeur Forceps	95	Tampons Cannula	131
RUST Resection Saws	19	TAYLOR Bone Levers	62
SACHS Dura Dissectors	126, 130	TC Wire Cutter	114
SACHS Hooks	128	Tendon Seizing Instruments	65
SACHS Nerve Root Retractors	127	TESSIER Bone Cutting Forceps	4, 100
SALENIUS Meniscotomy Knives	63	Tighteners, Bone Wire	119
SATTERLEE Resection Saws	18	Tighteners, Wire	109
SAUERBRUCH Bone Rongeur Forceps	98	Tightening Pliers, Wire	105
Saw Guide	122	TOENNIS Dura Dissectors	129
Saw, Amputation	19	TORNADO Bandage Scissors	3
Saw, Finger Ring	26	Traction Hooklet	117
Saw, Handles	18	Traction Tongs, Skull	123
Saw, Post Mortem	19	Trephines	20, 21, 110
Saw, Resection	19	TRILLAT Bone Files	11
Saw, Wire	17, 122	TRILLAT-POIRIER Gouges	43
SCHEDE Bone Curettes	29	TROCHLEAR Nasal Rasps	14
SCOVILLE Nerve Root Retractors	126	TROTTER Bone Rongeur Forceps	91
Screw Drivers	24	Tubes, Suction	131
SEDILLOT Periosteal Elevators	56	TUPPIER Bone Holding Forceps	80
SEIFFERT Suction Tubes	131	Tumor Grasping Forceps	139
Seizing, Tendon Instruments	65	Twist Drill	20, 21
Self-Centering Forceps	78	Twister Pliers, Wire	110
SEMB Bone Cutting Forceps	103	Twisters, Wire	104-106, 109
SEMB Bone Holding Forceps	72	Twisting Forceps, Wire	104, 111
SEMB Bone Rongeur Forceps	95	Twisting Pliers, Wire	107, 108
SEMB Periosteal Elevators	54	ULRICH Bone Holding Forceps	79
SEUTIN Bone Cutting Forceps	4	UNIVERSAL Bone Cutting Forceps	4
Shear Cutter	106	UNIVERSAL Bone Rongeur Forceps	87
Shears, Plaster of Paris	6	US. KIRSCHNER EXTENSION BOWS	117
SHERMAN-STILLE Hand Drills	21	USA. MOD. BONE CURETTES	30
SIMON Bone Curettes	30	VAN BUREN Bone Holding Forceps	71
Skid, Bone	13	VBERBRUGGE Bone Holding Forceps	78
Skull Breaker	45	VELPEAU Bone Cutting Forceps	100
Skull Traction Tongs	123	VERBRUGGE Bone Holding Forceps	75, 76
Slip Joint Plier	110	VERBRUGGE PREHENSEUR Bone Holding Forceps	75
SMILLIE Meniscotomy Knives	63	VIRCHOW Skull Breaker	45
SMITH (MOD. USA) Bandage Scissors	2	VOLKMANN Bone Curettes	27, 28, 31
SMITH-KERRISON-FRERRIS Intervertebral Disc Rongeurs	136	VOLKMANN Bone Hooks	52
SMITH-PETERSON Bone Osteotomes Chisels, Gouges	37, 44	WAGNER Mallets	9
SMITH-PETERSON Bone Rongeur Forceps	94	WAGNER Spongiosa Gouges	50
SMITHWICK Clip Applying Forceps	124	WALTON Ring Cutter	26
SMITHWICK Dissectors	129	WARD-EAST GRINSTEAD Bone Chisels & Osteotomes	34
Spare Blade for Ring Cutters	26	WILLIAMS Screw Drivers	24
Spatula Brains	125	WILLIGER Bone Curettes	27, 29
Spherical Burr	20, 21	WILLIGER Elevators	53
Spinal Elevator	45	WILLIGER Mallets	7
Spongiosa Gouge	47, 49, 50	WILLIGER Periosteal Elevators	55

WILMS Bone Rongeur Forceps	91
Wire Cutting Pliers	106, 108, 110, 112-116
Wire Guides, Bone	118
Wire Passers	119
Wire Pulling Forceps	108
Wire Saws	17, 122
Wire Tighteners	109, 119
Wire Tightening Pliers	105
Wire Twister	104, 106-111
Wire Twister Pliers	110
Wire Twisting Forceps	104, 111
Wire Twisting Pliers	107, 108
WOLFF Plaster Cast Spreaders	5
Wound Spreaders	133
YASARGIL Laminectomy Rongeurs	139
ZAUFAL-JANSEN Bone Rongeur Forceps	93
ZYGOMA Bone Hooks	52



Index by Code



Index by Code

Code	Page
21-0398-24	2
21-2025-24T	2
21-3001-18	1
21-3005-18	1
21-3010-20	1
21-3015-21	1
21-3020-20	2
21-3025-24	2
21-3030-24	2
21-3035-23	3
21-3040-16	3
21-3040-19	3
21-3045-24	3
23-0206-02	33
23-0206-03	33
23-0206-04	33
23-0206-05	33
23-0206-06	33
23-0207-02	33
23-0207-03	33
23-0207-04	33
23-0207-05	33
23-0207-06	33
23-0210-02	33
23-0210-03	33
23-0210-04	33
23-0210-05	33
23-0210-06	33
23-0211-02	33
23-0211-03	33
23-0211-04	33
23-0211-05	33
23-0211-06	33
23-0233-04	46
23-0233-06	46
23-0233-08	46
23-0233-10	46
23-0233-12	46
23-0234-04	46
23-0234-06	46
23-0234-08	46
23-0234-10	46
23-0234-12	46
23-0299-02	11
23-0299-03	11
23-0299-04	11
23-0299-05	11
23-0299-06	11
23-0299-08	11
23-0299-10	11
23-0301-01	7
23-0301-02	7
23-0301-03	7
23-0305-01	7
23-0305-02	7
23-0305-03	7
23-0309-20	7
23-0315-01	7
23-0315-02	7
23-0317-01	7
23-0381-01	31
23-0381-02	31
23-0381-03	31
23-0381-04	31
23-0381-05	31

Code	Page
23-0381-06	31
23-0381-10	31
23-0381-20	31
23-0381-30	31
23-0381-40	31
23-0405-01	28
23-0405-02	28
23-0405-03	28
23-0405-04	28
23-0405-05	28
23-0405-06	28
23-0405-10	28
23-0405-20	28
23-0405-30	28
23-0405-40	28
23-0409-01	28
23-0409-02	28
23-0409-03	28
23-0409-04	28
23-0409-05	28
23-0409-06	28
23-0409-10	28
23-0409-20	28
23-0409-30	28
23-0409-40	28
23-0445-01	30
23-0445-02	30
23-0445-03	30
23-0445-04	30
23-0445-05	30
23-0445-06	30
23-0446-01	30
23-0446-02	30
23-0446-03	30
23-0446-04	30
23-0446-05	30
23-0446-06	30
23-0448-01	30
23-0448-02	30
23-0448-03	30
23-0448-04	30
23-0448-05	30
23-0448-06	30
23-0459-00	27
23-0459-01	27
23-0459-12	27
23-0512-05	56
23-0512-06	56
23-0512-07	56
23-0591-01	16
23-0591-02	16
23-0591-03	16
23-0591-04	16
23-0601-15T	104
23-0621-20T	104
23-0900-12	86
23-0902-14	86
23-0906-14	87
23-0908-17	88
23-0920-18	88
23-0936-15	89
23-0938-15	89
23-0940-15	89
23-0954-15	89
23-0965-15	89

Code	Page
23-0966-15	89
23-0980-18	93
23-0988-18	93
23-1040-15	99
23-1040-17	99
23-1048-16	100
23-1051-18	101
23-1052-18	101
23-2055-00	29
23-2055-01	29
23-2055-02	29
23-2055-03	29
23-2056-00	29
23-2056-01	29
23-2056-02	29
23-2056-03	29
23-2145-18	90
23-2150-15	93
23-2155-18	93
23-3001-23	4
23-3005-19	4
23-3010-19	4
23-3015-20	4
23-3020-18	5
23-3020-24	5
23-3025-30	5
23-3030-28	5
23-3035-28	5
23-3040-23	5
23-3050-18	6
23-3055-24	6
23-3060-20	6
23-3061-20	6
23-3065-23	6
23-3065-26	6
23-3065-37	6
23-3066-23	6
23-3066-26	6
23-3066-37	6
23-3070-17	8
23-3071-17	8
23-3075-18	8
23-3076-16	8
23-3077-18	8
23-3080-18	8
23-3085-19	8
23-3086-19	8
23-3090-19	8
23-3091-19	8
23-3095-00	8
23-3096-00	8
23-3097-00	8
23-3100-00	8
23-3101-00	8
23-3105-19	8
23-3110-18	9
23-3115-19	9
23-3120-24	9
23-3125-24	9
23-3130-23	9
23-3135-23	9
23-3140-00	9
23-3141-00	9
23-3145-00	9
23-3150-23	9

Code	Page
23-3155-26	10
23-3156-26	10
23-3160-26	10
23-3165-00	10
23-3170-00	10
23-3175-00	10
23-3180-00	10
23-3185-00	10
23-3190-00	10
23-3195-17	11
23-3201-20	11
23-3202-20	11
23-3205-16	11
23-3210-21	11
23-3211-21	11
23-3215-28	12
23-3220-24	12
23-3225-22	12
23-3230-30	13
23-3235-27	13
23-3240-21	13
23-3245-30	13
23-3250-17	14
23-3255-21	14
23-3260-21	14
23-3261-21	14
23-3265-18	14
23-3266-18	14
23-3270-17	14
23-3275-16	14
23-3280-19	15
23-3281-19	15
23-3285-20	15
23-3290-18	15
23-3295-18	15
23-3301-21	15
23-3305-18	15
23-3305-21	15
23-3310-18	16
23-3315-15	17
23-3320-14	17
23-3325-14	17
23-3330-30	17
23-3335-18	17
23-3340-21	17
23-3345-30	17
23-3345-40	17
23-3345-50	17
23-3345-70	17
23-3350-30	17
23-3350-40	17
23-3350-50	17
23-3351-50	17
23-3355-00	18
23-3360-00	18
23-3365-00	18
23-3370-20	18
23-3375-23	18
23-3380-35	18
23-3385-27	18
23-3385-30	18
23-3385-34	18
23-3390-30	18
23-3395-30	19
23-3401-00	19

Index by Code

Code	Page	Code	Page	Code	Page	Code	Page
23-3405-00	19	23-3530-25	24	23-3662-27	31	23-3738-17	32
23-3410-42	19	23-3535-17	24	23-3663-27	31	23-3739-17	32
23-3415-39	19	23-3535-25	24	23-3664-27	31	23-3740-18	33
23-3420-00	19	23-3540-17	24	23-3670-23	31	23-3741-18	33
23-3425-27	20	23-3540-25	24	23-3671-23	31	23-3742-18	33
23-3426-27	20	23-3545-17	24	23-3672-23	31	23-3743-18	33
23-3427-27	20	23-3545-25	24	23-3673-23	31	23-3744-18	33
23-3430-27	20	23-3550-17	24	23-3674-23	31	23-3754-18	33
23-3431-27	20	23-3550-25	24	23-3675-23	31	23-3750-18	33
23-3432-27	20	23-3555-17	24	23-3676-23	31	23-3751-18	33
23-3435-00	20	23-3555-25	24	23-3677-23	31	23-3752-18	33
23-3436-00	20	23-3560-18	24	23-3678-23	31	23-3753-18	33
23-3437-00	20	23-3565-00	24	23-3680-23	31	23-3754-18	33
23-3438-00	20	23-3566-00	24	23-3681-23	31	23-3755-18	33
23-3439-00	20	23-3567-00	24	23-3682-23	31	23-3760-16	34
23-3440-00	20	23-3568-00	24	23-3683-23	31	23-3761-16	34
23-3441-00	20	23-3570-00	25	23-3684-23	31	23-3765-16	34
23-3442-00	20	23-3571-00	25	23-3685-23	31	23-3766-16	34
23-3443-00	20	23-3575-17	26	23-3686-23	31	23-3770-18	34
23-3445-00	21	23-3580-16	26	23-3687-23	31	23-3771-18	34
23-3445-24	21	23-3581-16	26	23-3688-23	31	23-3772-18	34
23-3450-00	21	23-3585-17	26	23-3690-28	31	23-3773-18	34
23-3451-00	21	23-3590-15	26	23-3691-28	31	23-3774-18	34
23-3452-00	21	23-3595-13	26	23-3692-28	31	23-3780-18	34
23-3455-00	21	23-3601-14	26	23-3693-28	31	23-3781-18	34
23-3455-20	21	23-3605-14	26	23-3694-28	31	23-3782-18	34
23-3456-00	21	23-3610-21	27	23-3695-28	31	23-3783-18	34
23-3457-00	21	23-3615-14	27	23-3696-28	31	23-3785-18	34
23-3458-00	21	23-3620-13	27	23-3697-28	31	23-3790-18	34
23-3459-00	21	23-3620-14	27	23-3698-28	31	23-3791-18	34
23-3460-00	21	23-3620-17	27	23-3700-28	31	23-3795-19	34
23-3461-00	21	23-3625-13	27	23-3701-28	31	23-3796-19	34
23-3462-00	21	23-3625-16	27	23-3702-28	31	23-3800-18	34
23-3463-00	21	23-3625-20	27	23-3703-28	31	23-3801-18	34
23-3464-00	21	23-3630-01	28	23-3704-28	31	23-3805-12	35
23-3465-00	21	23-3630-02	28	23-3705-28	31	23-3806-12	35
23-3466-00	21	23-3630-03	28	23-3706-28	31	23-3807-12	35
23-3467-00	21	23-3630-04	28	23-3707-28	31	23-3808-12	35
23-3470-00	22	23-3630-05	28	23-3708-28	31	23-3809-12	35
23-3475-14	22	23-3630-06	28	23-3710-13	32	23-3810-12	35
23-3475-15	22	23-3630-10	28	23-3711-13	32	23-3811-12	35
23-3476-00	22	23-3630-20	28	23-3712-13	32	23-3815-17	35
23-3480-00	22	23-3630-30	28	23-3713-13	32	23-3816-17	35
23-3485-00	22	23-3630-40	28	23-3714-13	32	23-3817-17	35
23-3486-00	22	23-3635-01	29	23-3715-13	32	23-3818-17	35
23-3487-00	22	23-3635-02	29	23-3716-13	32	23-3819-17	35
23-3488-00	22	23-3635-03	29	23-3717-13	32	23-3820-17	35
23-3490-24	23	23-3635-04	29	23-3718-13	32	23-3821-17	35
23-3495-00	23	23-3635-10	29	23-3719-13	32	23-3825-24	35
23-3496-00	23	23-3635-20	29	23-3720-13	32	23-3826-24	35
23-3501-00	23	23-3635-30	29	23-3721-13	32	23-3827-24	35
23-3501-00	109	23-3640-25	29	23-3722-13	32	23-3828-24	35
23-3502-00	23	23-3641-25	29	23-3723-13	32	23-3829-24	35
23-3502-00	109	23-3642-25	29	23-3724-13	32	23-3830-24	35
23-3505-00	23	23-3645-24	30	23-3725-14	32	23-3831-24	35
23-3505-00	109	23-3646-24	30	23-3726-14	32	23-3835-24	35
23-3510-00	23	23-3647-24	30	23-3727-14	32	23-3836-24	35
23-3510-00	109	23-3648-24	30	23-3730-17	32	23-3837-24	35
23-3511-00	23	23-3649-24	30	23-3731-17	32	23-3838-24	35
23-3511-00	109	23-3650-24	30	23-3732-17	32	23-3839-24	35
23-3512-00	23	23-3655-21	30	23-3733-17	32	23-3840-24	35
23-3512-00	109	23-3656-21	30	23-3734-17	32	23-3841-24	35
23-3515-00	23	23-3657-21	30	23-3735-17	32	23-3865-19	36
23-3520-24	24	23-3660-27	31	23-3736-17	32	23-3865-21	36
23-3525-17	24	23-3661-27	31	23-3737-17	32	23-3870-20	36

Code	Page
23-3871-20	36
23-3872-20	36
23-3873-20	36
23-3874-20	36
23-3880-20	36
23-3881-20	36
23-3882-20	36
23-3883-20	36
23-3884-20	36
23-3890-20	36
23-3891-20	36
23-3892-20	36
23-3893-20	36
23-3894-20	36
23-3900-20	36
23-3901-20	36
23-3902-20	36
23-3903-20	36
23-3904-20	36
23-3905-20	36
23-3910-20	36
23-3911-20	36
23-3912-20	36
23-3913-20	36
23-3914-20	36
23-3920-20	36
23-3921-20	36
23-3922-20	36
23-3923-20	36
23-3924-20	36
23-3930-20	37
23-3931-20	37
23-3932-20	37
23-3933-20	37
23-3934-20	37
23-3935-20	37
23-3936-20	37
23-3940-20	37
23-3941-20	37
23-3942-20	37
23-3943-20	37
23-3944-20	37
23-3945-20	37
23-3946-20	37
23-3950-20	37
23-3951-20	37
23-3952-20	37
23-3953-20	37
23-3955-20	37
23-3956-20	37
23-3957-20	37
23-3958-20	37
23-3960-24	38
23-3961-24	38
23-3962-24	38
23-3963-24	38
23-3964-24	38
23-3965-18	38
23-3966-18	38
23-3967-18	38
23-3968-18	38
23-3970-24	38
23-3971-24	38
23-3972-24	38
23-3973-24	38

Code	Page
23-3974-24	38
23-3975-24	38
23-3976-24	38
23-3980-18	38
23-3981-18	38
23-3982-18	38
23-3983-18	38
23-3984-18	38
23-3985-18	38
23-3986-18	38
23-3990-24	38
23-3991-24	38
23-3992-24	38
23-3993-24	38
23-3994-24	38
23-3995-24	38
23-3996-24	38
23-4001-18	38
23-4002-18	38
23-4003-18	38
23-4004-18	38
23-4005-18	38
23-4006-18	38
23-4007-18	38
23-4010-18	39
23-4010-23	39
23-4011-18	39
23-4011-23	39
23-4012-18	39
23-4012-23	39
23-4013-18	39
23-4013-23	39
23-4014-18	39
23-4014-23	39
23-4020-18	39
23-4020-23	39
23-4021-18	39
23-4021-23	39
23-4022-18	39
23-4022-23	39
23-4023-18	39
23-4023-23	39
23-4024-18	39
23-4024-23	39
23-4030-12	110
23-4030-19	110
23-4030-21	40
23-4030-25	110
23-4030-31	110
23-4030-38	110
23-4031-21	40
23-4032-21	40
23-4033-21	40
23-4034-21	40
23-4040-25	40
23-4041-25	40
23-4042-25	40
23-4043-25	40
23-4044-25	40
23-4045-25	40
23-4046-25	40
23-4047-25	40
23-4050-13	40
23-4051-13	40
23-4052-13	40

Code	Page
23-4053-13	40
23-4054-13	40
23-4055-13	40
23-4056-13	40
23-4060-22	40
23-4061-22	40
23-4062-22	40
23-4063-22	40
23-4064-22	40
23-4065-22	40
23-4070-35	40
23-4075-21	41
23-4080-20	41
23-4081-20	41
23-4082-20	41
23-4085-13	41
23-4090-14	41
23-4091-14	41
23-4092-14	41
23-4100-00	41
23-4101-00	41
23-4102-00	41
23-4103-00	41
23-4104-00	41
23-4105-00	41
23-4106-00	41
23-4107-00	41
23-4108-00	41
23-4109-00	41
23-4115-16	41
23-4116-16	41
23-4117-16	41
23-4118-16	41
23-4119-16	41
23-4120-16	41
23-4125-16	41
23-4126-16	41
23-4127-16	41
23-4128-16	41
23-4130-30	42
23-4131-30	42
23-4132-30	42
23-4135-28	42
23-4136-16	42
23-4137-16	42
23-4140-24	42
23-4141-24	42
23-4142-24	42
23-4143-24	42
23-4145-13	42
23-4146-13	42
23-4147-13	42
23-4148-13	42
23-4149-13	42
23-4150-13	42
23-4151-13	42
23-4155-29	42
23-4156-29	42
23-4157-29	42
23-4160-20	43
23-4161-20	43
23-4162-20	43
23-4163-20	43
23-4164-20	43
23-4165-20	43

Code	Page
23-4170-16	43
23-4171-16	43
23-4172-16	43
23-4173-16	43
23-4174-16	43
23-4175-16	43
23-4176-16	43
23-4180-25	43
23-4181-25	43
23-4182-25	43
23-4185-25	43
23-4190-23	44
23-4191-23	44
23-4192-23	44
23-4195-30	44
23-4196-30	44
23-4197-30	44
23-4198-30	44
23-4199-30	44
23-4200-30	44
23-4201-30	44
23-4202-30	44
23-4205-25	44
23-4206-25	44
23-4207-25	44
23-4208-25	44
23-4209-25	44
23-4210-25	44
23-4211-25	44
23-4212-25	44
23-4215-21	44
23-4216-21	44
23-4217-21	44
23-4218-21	44
23-4219-21	44
23-4220-21	44
23-4225-16	44
23-4226-16	44
23-4227-16	44
23-4228-16	44
23-4230-24	45
23-4235-00	45
23-4240-22	45
23-4245-28	45
23-4250-28	45
23-4255-29	45
23-4256-29	45
23-4257-29	45
23-4260-28	45
23-4261-28	45
23-4262-28	45
23-4263-28	45
23-4264-28	45
23-4270-22	46
23-4271-22	46
23-4272-22	46
23-4273-22	46
23-4274-22	46
23-4275-22	46
23-4280-22	46
23-4281-22	46
23-4282-22	46
23-4283-22	46
23-4284-22	46
23-4285-22	46

Index by Code

Code	Page	Code	Page	Code	Page	Code	Page
23-4300-25	47	23-4451-20	53	23-4650-00	61	23-4870-14	70
23-4301-25	47	23-4455-17	53	23-4655-00	61	23-4870-19	70
23-4302-25	47	23-4456-17	53	23-4660-00	61	23-4875-17	70
23-4305-25	47	23-4457-17	53	23-4665-16	62	23-4880-18	70
23-4306-25	47	23-4458-17	53	23-4666-16	62	23-4885-18	70
23-4307-25	47	23-4460-22	54	23-4670-17	62	23-4890-20	70
23-4310-24	48	23-4465-20	54	23-4675-24	62	23-4891-20	70
23-4315-26	48	23-4470-17	54	23-4676-24	62	23-4905-20	71
23-4320-27	48	23-4471-21	54	23-4680-26	62	23-4906-20	71
23-4321-27	48	23-4472-17	54	23-4685-26	62	23-4910-23	71
23-4325-27	48	23-4473-21	54	23-4690-17	63	23-4915-20	71
23-4326-27	48	23-4474-20	54	23-4691-17	63	23-4920-21	71
23-4330-25	49	23-4480-17	55	23-4692-17	63	23-4925-21	71
23-4331-25	49	23-4481-17	55	23-4695-17	63	23-4930-18	71
23-4332-25	49	23-4482-17	55	23-4696-17	63	23-4935-19	72
23-4335-23	49	23-4483-17	55	23-4701-19	63	23-4940-19	72
23-4336-23	49	23-4485-13	55	23-4702-19	63	23-4940-20	72
23-4337-23	49	23-4490-16	55	23-4705-22	63	23-4945-12	72
23-4338-23	49	23-4491-16	55	23-4710-22	63	23-4945-15	72
23-4340-25	49	23-4492-16	55	23-4715-22	64	23-4945-17	72
23-4341-25	49	23-4493-16	55	23-4716-22	64	23-4945-21	72
23-4342-25	49	23-4495-17	55	23-4720-18	64	23-4950-12	72
23-4345-28	50	23-4496-17	55	23-4725-25	64	23-4950-15	72
23-4346-28	50	23-4501-21	55	23-4730-25	64	23-4950-17	72
23-4350-34	50	23-4502-21	55	23-4735-20	65	23-4950-21	72
23-4351-34	50	23-4503-21	55	23-4736-20	65	23-4950-23	72
23-4352-34	50	23-4504-21	55	23-4740-16	65	23-4955-32	73
23-4355-34	50	23-4505-15	55	23-4745-15	65	23-4956-32	73
23-4356-34	50	23-4510-15	56	23-4745-19	65	23-4957-42	73
23-4357-34	50	23-4515-15	56	23-4745-24	65	23-4960-30	73
23-4360-34	50	23-4520-21	56	23-4750-10	65	23-4961-32	73
23-4361-34	50	23-4525-18	56	23-4751-10	65	23-4962-32	73
23-4362-34	50	23-4530-17	57	23-4752-10	65	23-4963-42	73
23-4365-18	51	23-4535-17	57	23-4753-10	65	23-4965-21	74
23-4366-08	51	23-4536-17	57	23-4755-09	66	23-4970-25	74
23-4367-08	51	23-4537-19	57	23-4756-09	66	23-4970-27	74
23-4368-08	51	23-4538-19	57	23-4760-13	66	23-4975-30	74
23-4369-08	51	23-4540-19	57	23-4765-13	66	23-4980-16	75
23-4370-08	51	23-4541-19	57	23-4770-16	66	23-4981-16	75
23-4371-08	51	23-4542-19	57	23-4775-14	66	23-4985-18	75
23-4372-08	51	23-4543-18	57	23-4775-16	66	23-4985-24	75
23-4373-08	51	23-4545-16	57	23-4780-12	67	23-4985-26	75
23-4375-09	51	23-4545-18	57	23-4785-13	67	23-4985-28	75
23-4376-00	51	23-4545-20	57	23-4790-00	67	23-4990-25	76
23-4380-13	51	23-4550-18	58	23-4795-17	67	23-4990-26	76
23-4381-13	51	23-4555-18	58	23-4800-15	67	23-4990-27	76
23-4382-13	51	23-4560-18	58	23-4800-17	67	23-4995-17	76
23-4385-20	52	23-4565-20	58	23-4800-20	67	23-4996-17	76
23-4390-23	52	23-4570-20	58	23-4805-12	68	23-5001-23	76
23-4395-25	52	23-4575-20	58	23-4805-14	68	23-5001-32	76
23-4400-23	52	23-4580-00	59	23-4810-17	68	23-5005-16	77
23-4401-23	52	23-4585-14	59	23-4815-13	68	23-5005-18	77
23-4402-23	52	23-4590-15	59	23-4820-13	68	23-5005-20	77
23-4405-18	52	23-4595-15	59	23-4825-16	68	23-5005-22	77
23-4410-17	52	23-4601-15	59	23-4830-15	69	23-5005-24	77
23-4415-16	53	23-4605-00	59	23-4830-18	69	23-5010-18	77
23-4416-16	53	23-4610-16	59	23-4830-20	69	23-5015-19	77
23-4417-16	53	23-4611-16	59	23-4830-30	69	23-5015-22	77
23-4418-16	53	23-4615-18	59	23-4835-21	69	23-5015-27	77
23-4420-20	53	23-4620-00	60	23-4840-17	69	23-5020-12	78
23-4421-20	53	23-4625-00	60	23-4845-20	69	23-5025-15	78
23-4445-17	53	23-4630-00	60	23-4850-14	69	23-5025-19	78
23-4450-17	53	23-4635-00	60	23-4855-15	69	23-5025-22	78
23-4450-20	53	23-4640-00	61	23-4860-14	70	23-5025-24	78
23-4451-17	53	23-4645-00	61	23-4865-12	70	23-5025-26	78

Code	Page
23-5025-28	78
23-5026-15	78
23-5026-19	78
23-5026-22	78
23-5026-24	78
23-5026-26	78
23-5026-28	78
23-5027-15	78
23-5027-19	78
23-5027-22	78
23-5027-24	78
23-5027-26	78
23-5027-28	78
23-5030-13	79
23-5030-15	79
23-5030-18	79
23-5030-23	79
23-5030-25	79
23-5030-27	79
23-5035-13	79
23-5035-15	79
23-5035-18	79
23-5035-23	79
23-5035-25	79
23-5035-27	79
23-5040-27	79
23-5045-19	80
23-5045-23	80
23-5045-26	80
23-5050-19	80
23-5050-23	80
23-5050-26	80
23-5055-27	80
23-5060-22	81
23-5060-27	81
23-5060-30	81
23-5065-22	81
23-5065-26	81
23-5065-33	81
23-5070-19	81
23-5070-23	81
23-5070-26	81
23-5075-08	82
23-5075-12	82
23-5075-18	82
23-5075-20	82
23-5075-22	82
23-5080-00	82
23-5085-12	83
23-5085-18	83
23-5085-20	83
23-5090-18	83
23-5090-20	83
23-5095-12	83
23-5095-18	83
23-5095-20	83
23-5101-19	84
23-5101-23	84
23-5101-25	84
23-5105-23	84
23-5105-25	84
23-5110-40	84
23-5115-40	85
23-5120-40	85
23-5125-00	85

Code	Page
23-5140-15	86
23-5141-15	86
23-5145-14	86
23-5146-14	86
23-5147-14	86
23-5148-15	86
23-5149-16	86
23-5150-17	87
23-5151-17	87
23-5155-13	87
23-5160-16	87
23-5165-16	87
23-5170-16	87
23-5175-18	88
23-5176-18	88
23-5177-18	88
23-5180-18	88
23-5181-18	88
23-5185-18	89
23-5190-17	89
23-5191-17	89
23-5195-17	90
23-5201-14	90
23-5205-19	90
23-5210-20	90
23-5215-20	90
23-5220-20	91
23-5225-20	91
23-5230-20	91
23-5235-21	91
23-5240-20	92
23-5245-16	92
23-5245-19	92
23-5246-16	92
23-5246-19	92
23-5250-16	92
23-5250-18	92
23-5251-16	92
23-5251-18	92
23-5255-15	92
23-5256-15	92
23-5257-15	92
23-5260-15	92
23-5261-15	92
23-5262-15	92
23-5265-17	93
23-5270-18	93
23-5271-18	93
23-5275-15	93
23-5276-15	93
23-5280-18	93
23-5281-18	93
23-5282-18	93
23-5283-18	93
23-5285-20	93
23-5286-20	93
23-5287-20	93
23-5288-20	93
23-5289-20	93
23-5295-15	93
23-5296-15	93
23-5297-15	93
23-5300-18	93
23-5301-18	93
23-5302-18	93

Code	Page
23-5303-18	93
23-5305-20	93
23-5306-20	93
23-5307-20	93
23-5308-20	93
23-5309-20	93
23-5315-23	94
23-5320-24	94
23-5321-24	94
23-5322-24	94
23-5325-20	94
23-5330-15	94
23-5331-15	94
23-5335-15	94
23-5340-15	94
23-5345-23	95
23-5346-23	95
23-5347-23	95
23-5350-23	95
23-5355-22	95
23-5360-23	95
23-5365-24	95
23-5370-24	96
23-5371-24	96
23-5372-24	96
23-5373-24	96
23-5374-24	96
23-5375-24	96
23-5380-23	96
23-5381-23	96
23-5382-23	96
23-5383-23	96
23-5384-23	96
23-5385-23	96
23-5390-22	97
23-5391-22	97
23-5392-22	97
23-5393-22	97
23-5394-22	97
23-5395-22	97
23-5396-22	97
23-5397-22	97
23-5398-22	97
23-5399-22	97
23-5401-23	97
23-5401-27	97
23-5402-23	97
23-5402-27	97
23-5405-30	98
23-5406-30	98
23-5410-36	98
23-5411-36	98
23-5412-36	98
23-5413-36	98
23-5415-00	98
23-5416-00	98
23-5417-00	98
23-5418-00	98
23-5420-14	99
23-5420-17	99
23-5420-19	99
23-5420-22	99
23-5425-14	99
23-5425-17	99
23-5425-19	99

Code	Page
23-5425-22	99
23-5430-12	99
23-5435-15	99
23-5440-15	100
23-5445-18	100
23-5450-20	100
23-5455-20	100
23-5460-16	100
23-5465-15	100
23-5470-14	100
23-5475-24	100
23-5480-14	101
23-5485-17	101
23-5490-17	101
23-5495-24	101
23-5501-27	102
23-5505-27	102
23-5510-27	102
23-5515-27	103
23-5520-24	103
23-5525-15T	104
23-5530-16T	104
23-5535-18T	104
23-5535-20T	104
23-5540-00T	104
23-5545-15T	105
23-5550-17T	105
23-5560-20T	105
23-5565-18T	105
23-5566-18T	105
23-5567-18T	105
23-5570-18T	105
23-5571-18T	105
23-5575-16	106
23-5580-15	106
23-5585-16	106
23-5590-00	106
23-5595-17	106
23-5596-17	106
23-5601-16	106
23-5605-14	106
23-5610-14	107
23-5615-14	107
23-5620-14T	107
23-5623-14	107
23-5625-15	108
23-5630-19	108
23-5635-16	108
23-5640-18	108
23-5655-00	109
23-5670-18	109
23-5675-00	109
23-5680-00	109
23-5685-00	109
23-569018	109
23-5695-20	110
23-5710-13	110
23-5710-17	110
23-5715-12	110
23-5715-17	110
23-5720-18	110
23-5730-00	110
23-5731-00	110
23-5732-00	110
23-5760-17	111

Index by Code

Code	Page	Code	Page	Code	Page	Code	Page
23-5760-20	111	23-5928-00	118	24-4090-19	125	24-4320-20	133
23-5760-25	111	23-5929-00	118	24-4095-17	125	24-4325-16	133
23-5765-24	111	23-5930-28	119	24-4095-20	125	24-4330-18	133
23-5765-30	111	23-5935-21	119	24-4095-28	125	24-4335-20	133
23-5770-16	112	23-5940-00	119	24-4101-18	125	24-4340-00	134
23-5775-16	112	23-5945-00	119	24-4102-18	125	24-4345-15	134
23-5780-00	112	23-5950-00	119	24-4103-18	125	24-4346-15	134
23-5785-16T	112	23-5955-26	119	24-4104-18	125	24-4347-15	134
23-5785-18T	112	23-5956-26	119	24-4105-18	125	24-4350-20	134
23-5785-20T	112	23-5957-26	119	24-4106-18	125	24-4351-20	134
23-5790-14T	112	23-5960-35	119	24-4107-18	125	24-4355-15	135
23-5790-16T	112	23-5965-00	119	24-4108-18	125	24-4355-20	135
23-5790-18T	112	23-5966-00	119	24-4110-24	126	24-4356-15	135
23-5795-22T	112	23-5970-29	119	24-4115-21	126	24-4356-20	135
23-5801-14T	112	23-5970-37	119	24-4120-20	126	24-4360-15	135
23-5801-16T	112	23-5970-42	119	24-4125-20	126	24-4360-20	135
23-5801-18T	112	23-5970-49	119	24-4130-21	126	24-4361-15	135
23-5801-22T	112	23-5975-00	119	24-4135-23	126	24-4361-20	135
23-5805-15	113	23-5976-00	119	24-4140-24	126	24-4365-15	136
23-5810-24	113	23-5977-00	119	24-4145-21	127	24-4365-18	136
23-5815-18T	113	23-5978-00	119	24-4150-21	127	24-4365-20	136
23-5820-17T	113	23-5980-00	120	24-4155-21	127	24-4366-15	136
23-5825-22T	113	23-5985-00	120	24-4160-23	127	24-4366-18	136
23-5830-32	113	23-5990-00	120	24-4165-21	127	24-4366-20	136
23-5835-32	113	23-5995-00	120	24-4170-20	128	24-4367-15	136
23-5840-25	114	23-6001-00	120	24-4175-20	128	24-4367-18	136
23-5845-38	114	23-6002-00	120	24-4180-20	128	24-4367-20	136
23-5850-38T	114	23-6003-00	120	24-4185-19	128	24-4368-15	136
23-5850-45T	114	23-6004-00	120	24-4185-28	128	24-4368-18	136
23-5850-56T	114	23-6005-21	120	24-4186-19	128	24-4368-20	136
23-5855-30	115	23-6010-21	120	24-4186-28	128	24-4369-15	136
23-5855-47	115	23-6015-21	120	24-4190-16	128	24-4369-18	136
23-5860-48	115	23-6020-63	120	24-4195-18	128	24-4369-20	136
23-5865-24	116	23-6021-00	120	24-4201-14	128	24-4370-15	136
23-5870-38	116	23-6022-00	120	24-4205-13	128	24-4370-18	136
23-5875-09	117	23-6023-00	120	24-4205-18	128	24-4370-20	136
23-5875-11	117	23-6024-00	120	24-4206-13	128	24-4375-15	136
23-5875-12	117	23-6025-00	120	24-4206-18	128	24-4375-18	136
23-5875-15	117	23-6045-00	121	24-4210-29	129	24-4375-20	136
23-5875-17	117	23-6046-00	121	24-4215-20	129	24-4376-15	136
23-5875-23	117	23-6050-22	121	24-4220-19	129	24-4376-18	136
23-5880-07	117	23-6060-00	121	24-4220-24	129	24-4376-20	136
23-5880-10	117	23-6065-00	121	24-4225-18	129	24-4377-15	136
23-5880-12	117	24-4001-21	122	24-4225-24	129	24-4377-18	136
23-5880-15	117	24-4005-20	122	24-4230-25	129	24-4377-20	136
23-5881-15	117	24-4010-22	122	24-4235-21	130	24-4378-15	136
23-5885-00	117	24-4015-33	122	24-4240-22	130	24-4378-18	136
23-5890-00	117	24-4020-00	123	24-4245-21	130	24-4378-20	136
23-5895-10	117	24-4025-00	123	24-4250-21	130	24-4379-15	136
23-5895-16	117	24-4040-00	123	24-4255-29	130	24-4379-18	136
23-5901-20	117	24-4041-00	123	24-4260-17	130	24-4379-20	136
23-5902-27	117	24-4045-00	123	24-4265-21	130	24-4380-15	136
23-5903-00	117	24-4046-00	123	24-4270-15	131	24-4380-18	136
23-5904-00	117	24-4050-15	124	24-4275-15	131	24-4380-20	136
23-5905-00	117	24-4050-19	124	24-4280-15	131	24-4385-15	136
23-5906-00	117	24-4055-15	124	24-4285-12	131	24-4385-18	136
23-5910-27	118	24-4055-19	124	24-4286-12	131	24-4385-20	136
23-5910-28	118	24-4060-23	124	24-4290-12	131	24-4386-15	136
23-5910-30	118	24-4060-26	124	24-4295-11	131	24-4386-18	136
23-5915-24	118	24-4065-23	124	24-4301-24	132	24-4386-20	136
23-5915-27	118	24-4065-25	124	24-4305-27	132	24-4387-15	136
23-5920-22	118	24-4070-14	124	24-4310-16	132	24-4387-18	136
23-5925-00	118	24-4075-16	124	24-4315-10	133	24-4387-20	136
23-5926-00	118	24-4080-19	125	24-4315-12	133	24-4388-15	136
23-5927-00	118	24-4085-19	125	24-4320-16	133	24-4388-18	136

Notes

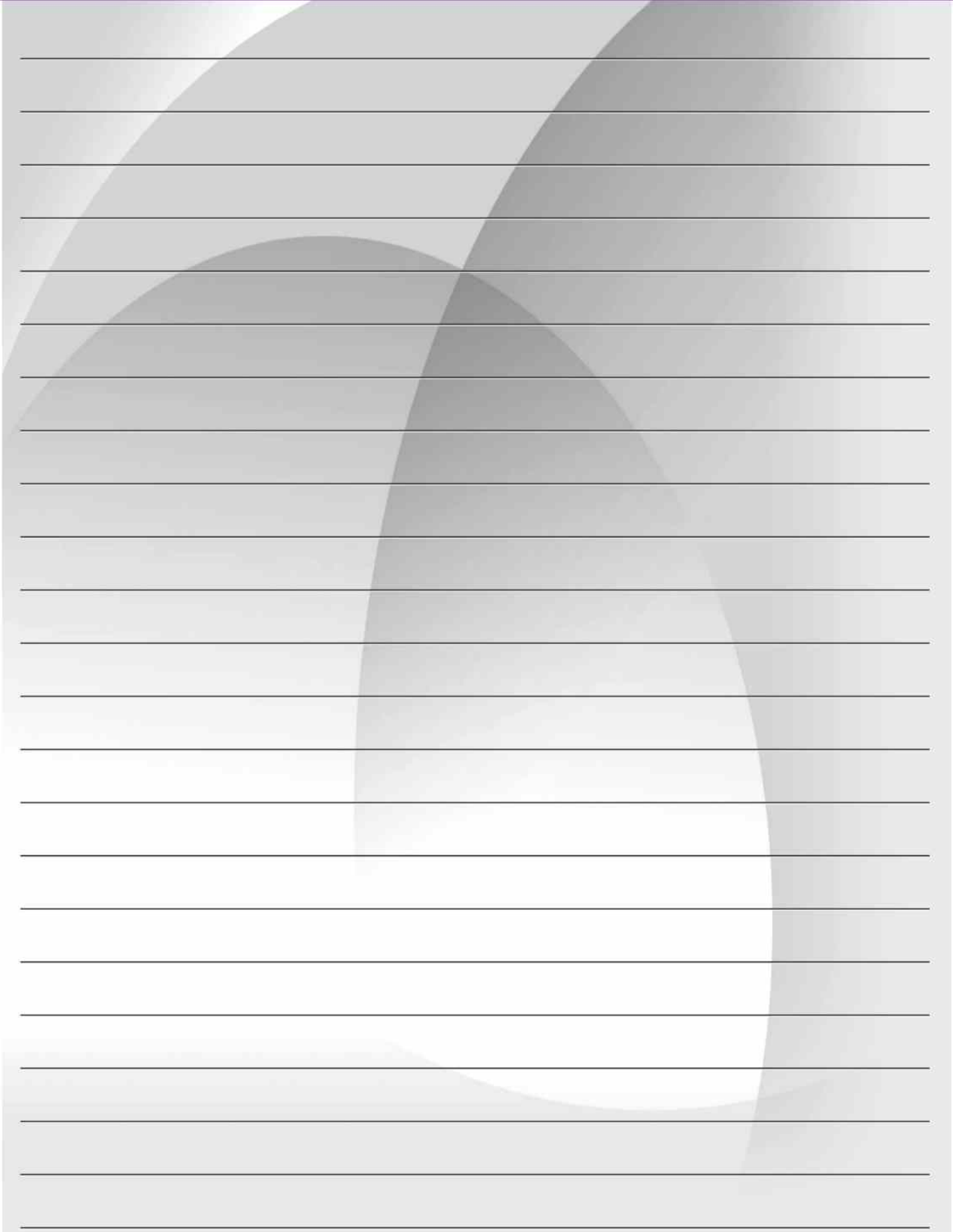

A large rectangular area for taking notes, featuring horizontal lines. A large, semi-transparent graphic consisting of overlapping circles in shades of gray and purple is centered behind the lines.

ASC MEDICAL Surgical Instruments and Implants are guaranteed to be free of defects in materials and workmanship for life.

ASC MEDICAL Surgical Instruments and Implants that are determined to be defective will be replaced or repaired, at our discretion.

ASC MEDICAL Surgical Instruments and Implants not properly cared for or used for purposes not intended will not be covered.

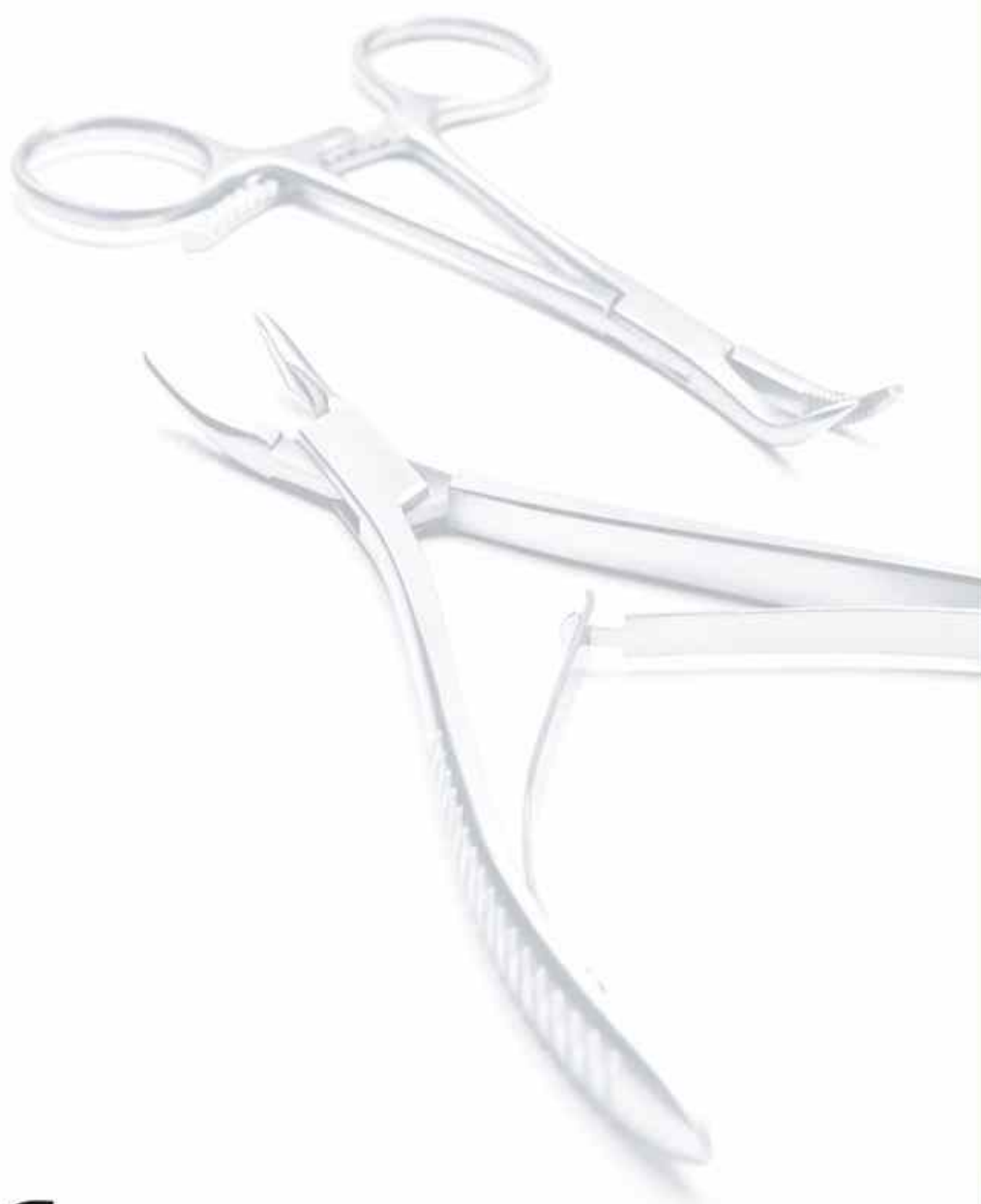

ASC Medical GmbH & Company KG
take-off GewerbePark 2
78579 Neuhausen o.E. | Tuttlingen, Germany

Phone: + 49 (0) 7467 - 94 960 46
Fax: + 49 (0) 7467 - 94 960 49
www.asc-med.com - info@asc-med.com