



Surgical Instruments





Welcome to ASC Medical GmbH & Co. KG.

The company was founded by Kurt Bucher in the year 2003.

The **ASC MEDICAL** office is located in the heart of Southern Germany, Neuhausen / Tuttlingen.

ASC MEDICAL is dedicated to educating the market on new and improved techniques, implants and instrumentation.

Since the formation of **ASC MEDICAL**, we have dedicated ourselves of bringing instruments and implants at a competitive value to the Medical Market. We are proud of what we have achieved in the last 7 years and look forward to more of the same for many years to come.

When you purchase from **ASC MEDICAL**, you are guaranteed the best in quality and customer service. We not only meet your expectations, we exceed them!

This is what we set out to deliver and has since become known as the "**ASC MEDICAL Philosophy**".

On behalf of the **ASC MEDICAL** team members and our distribution partners, we thank you for your tremendous trust in the past. And with your support, we will continue to deliver the highest quality surgical instruments and implants on the market.

Kurt Bucher
President

Diagnostic	1, 2
Percussion Hammers	3, 4
Anaesthesia	5
Trocars	6-8
Suction Tubes	9-12
Handles	13-16
Razor Blade Holder	17
Scissors	18-55
Dressing and Tissue Forceps	56-70
Artery Forceps	71-103
Tubing Clamps	104
Cotton Swab Forceps	105-113
Intestinal and Stomach	114-120
Retractors	121-167
General Instruments	168, 169
Needle Holders	170-188
Suture Needles	189-199

Special Note:

ASC is carrying the full range of over 18000 different surgical instruments.

Please do not hesitate to contact us for any instrument which you do not find in this catalogue.

Examination and Measuring Instruments (Calipers)
Prüf- und Messinstrumente
Instrumentos de exámenes y de medidas (Calibres)



Townley
17-3060-10
10 cm / 4"



Marchac
17-3065-00
Measuring rang 80 mm



Jamison
17-3070-00

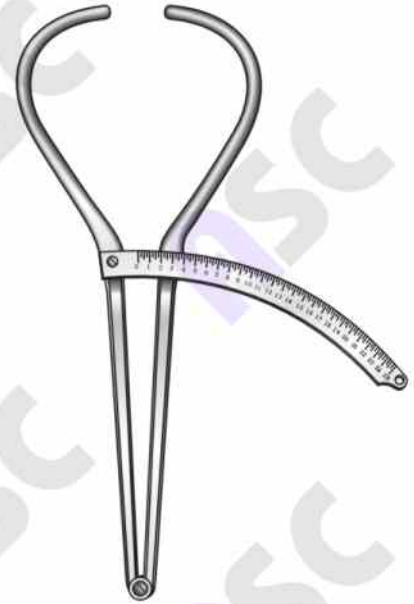

Bertillon
17-3075-00



Moltgen
17-3080-00
For extremities



Thole
17-3085-34
34 cm / 13 1/2"
Goniometer, graduated in centimeters.
For internal & external measurements.

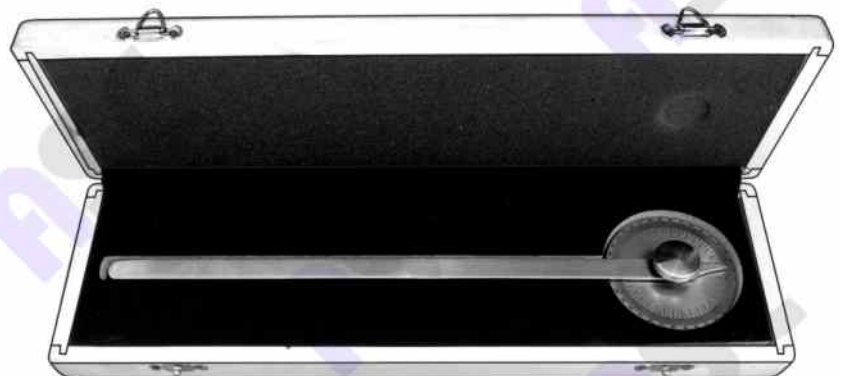

17-3090-00
Goniometer

Examination and Measuring Instruments (Calipers)
Prüf- und Messinstrumente
Instrumentos de exámenes y de medidas (Calibres)



Castroviejo
17-3095-08
8 cm / 3 1/4"
Measuring range 15 mm

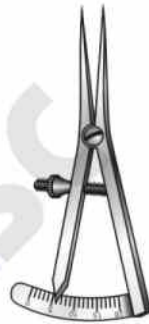

Castroviejo
17-3100-08
8 cm / 3 1/4"
Measuring range 20 mm

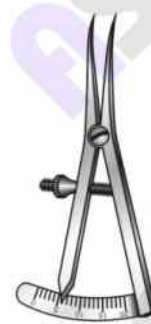

Castroviejo
17-3105-08
8 cm / 3 1/4"
Measuring range 20 mm
Curved



Castroviejo-Epker
17-3110-09
9 cm / 3 1/2"
Measuring range 40 mm

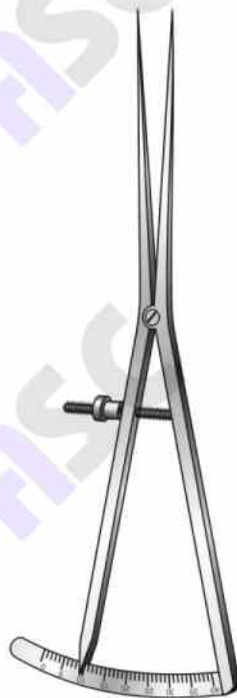

Castroviejo-Epker
17-3115-18
18 cm / 7"
Measuring range 40 mm



Castroviejo-Epker
17-3120-18
18 cm / 7"
Measuring range 40 mm
Curved

Percussion Hammers
Perkussionshammer
Martillos de percusión



Taylor
18-3125-18 18 cm / 7"
18-3126-20 20 cm / 8"
 Stainless steel
18-3130-18 18 cm / 7"
18-3131-20 20 cm / 8"
 Chrome plated
 (Brass)



Dejerine
18-3135-20
 Stainless steel
18-3136-20
 20 cm / 8"
 Chrome plated
 (Brass)



Dejerine
18-3140-21
 Stainless steel
18-3141-21
 21 cm / 8 1/4"
 Chrome plated
 (Brass)
 With needle



18-3142-00
 Spare needle only



Buck
18-3145-18
 Stainless steel
18-3146-18
 Chrome plated
 (Brass)
 18 cm / 7"
 With needle and brush



Berliner
18-3155-17
 17 cm / 6 1/2"
18-3155-20
 20 cm / 8"
 (Brass)



Troemner
18-3160-24
 Stainless steel
18-3161-24
 Chrome plated
 (Brass)
 24.5 cm / 9 1/2"



Traube
18-3165-19
 Stainless steel
18-3166-19
 Chrome plated
 (Brass)
 19 cm / 7 1/2"
 190 gm
 Wooden handle

18-3147-00
 Spare rubber large

18-3148-00
 Spare rubber small

18-3162-00
 Spare rubber large

18-3163-00
 Spare rubber small

18-3149-00
 Spare needle only

18-3150-00
 Spare brush only

Percussion Hammers
Perkussionshammer
Martillos de percusión





Magill
Catheter introducing forceps

Trocars
Trokare
Trocares



Universal
18-3001-00
Set of 3 pieces
18-3002-00
Set of 4 pieces
14 cm / 5½"



Standard
18-3005-11 3 mm Ø
18-3006-11 4 mm Ø
18-3007-11 5 mm Ø
18-3008-11 6 mm Ø
18-3009-11 3.5 mm Ø
18-3010-11 4.5 mm Ø
18-3011-11 5.5 mm Ø
11 cm / 4¼"



Standard
18-3015-12 3 mm Ø
18-3016-12 4 mm Ø
18-3017-12 5 mm Ø
18-3018-12 6 mm Ø
18-3019-12 3.5 mm Ø
18-3020-12 4.5 mm Ø
18-3021-12 5.5 mm Ø
12 cm / 4¾"



Standard
18-3025-12 3 mm Ø
18-3026-12 4 mm Ø
18-3027-12 5 mm Ø
18-3028-12 6 mm Ø
18-3029-12 3.5 mm Ø
18-3030-12 4.5 mm Ø
18-3031-12 5.5 mm Ø
12 cm / 4¾"



Nelson
21 cm / 8½"



18-3035-21



18-3036-21



18-3037-21



Duke
18-3040-11
11 cm / 4½"
5.5 mm Ø

Trocars
Trocare
Trocares

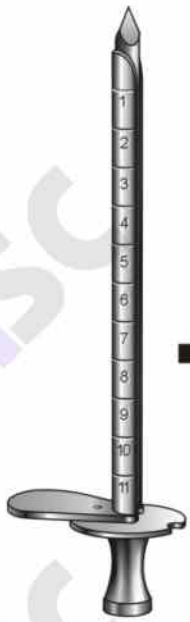

Campbell
16 cm / 6 1/4"



18-3045-16
6 mm Ø



18-3046-16
8 mm Ø



Fleurant
18-3050-23
23 cm / 9"
5 mm Ø

Fleurant
18-3055-23
23 cm / 9"
5 mm Ø



Buelau
18-3060-24
24 cm / 9 1/2"
8 mm Ø



Ochsner
18-3065-14 4 mm Ø
18-3066-14 5.5 mm Ø
18-3067-14 6.5 mm Ø
14 cm / 5 1/2"



Billroth
18-3070-24 5 mm Ø
18-3071-24 6 mm Ø
24 cm / 9 1/2"

Trocars
Trokare
Trocares



Landau
18-3075-00
2 mm Ø



Lichtwitz
18-0591-18
1.8 mm Ø



Pierce
18-0596-03 3 mm Ø
18-0596-04 4 mm Ø
18-0596-05 5 mm Ø



Krause
18-0606-55
5.5 mm Ø
Antrum trocar,
with obturator and tubing connection



Coakley
18-0616-22
2.25 mm Ø
Antrum trocar,
with washing tube and
fixed tubing connection



Douglas
18-0620-03
3 mm Ø
Trocar cannula



18-0621-11
11 cm / 4 1/2"
Antrum puncture trocar



Yankauer

18-2001-23	18-0644-23
23 cm / 9"	23 cm / 9"
Chrome plated	Stainless steel
18-2002-27	18-0644-27
27 cm / 11"	27 cm / 11"
Chrome plated	Stainless steel
Without thumb control	



Yankauer

18-2001-00	Stainless steel
18-2001-01	Chrome plated
28 cm / 11"	
With thumb control	



Poole
Stainless steel
22 cm / 8 3/4"

18-3080-22
8 mmØ, (Fr 23)
18-0651-22
10 mmØ, (Fr 30)



Poole
Stainless steel
22 cm / 8 3/4"

18-0652-22
8 mmØ, (Fr 23)
18-3085-22
10 mmØ, (Fr 30)

Suction Tubes
Saugrohre
Tubos de aspiración



- 18-0676-01** 1.5 mm Ø
- 18-0676-02** 2.0 mm Ø
- 18-0676-03** 2.5 mm Ø
- 18-0676-04** 3.5 mm Ø



- 18-0676-05** 1.5 mm Ø
 - 18-0676-06** 2.0 mm Ø
 - 18-0676-07** 2.5 mm Ø
 - 18-0676-08** 3.5 mm Ø
- With additional side holes



Adson
18-0622-21
21 cm / 8½"
4 mm Ø



Frazier

Fr	mm
18-0624-06	06 2
18-0624-07	07 2.3
18-0624-08	08 2.6
18-0624-09	09 3
18-0624-10	10 3.3
18-0624-11	11 3.6
18-0624-12	12 4
18-0624-14	14 4.6
18-0624-16	16 5

19 cm / 7½"

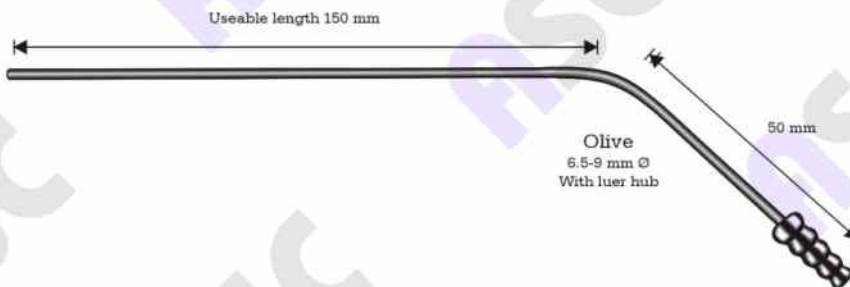

Yasargil

18-0641-15	150 mm x 1.5 mm
18-0641-20	180 mm x 2.0 mm
18-0641-25	150 mm x 2.5 mm
18-0641-30	150 mm x 3.5 mm

11 cm / 4¼"



Frazier
18-0623-10
9 fr. 3 mm



Prazier

18-3090-00	6 Fr	2 mm
18-3091-00	7 Fr	2.3 mm
18-3092-00	8 Fr	2.6 mm
18-3093-00	9 Fr	3 mm
18-3094-00	10 Fr	3.3 mm
18-3095-00	11 Fr	3.6 mm
18-3096-00	12 Fr	4 mm
18-3097-00	14 Fr	4.6 mm
18-3098-00	16 Fr	5 mm

Ear suction tube



Prazier

18-3100-00	6 Fr	2 mm
18-3101-00	7 Fr	2.3 mm
18-3102-00	8 Fr	2.6 mm
18-3103-00	9 Fr	3 mm
18-3104-00	10 Fr	3.3 mm
18-3105-00	11 Fr	3.6 mm
18-3106-00	12 Fr	4 mm
18-3107-00	14 Fr	4.6 mm
18-3108-00	16 Fr	5 mm



Unit Auditive

	Inside	Outside
18-3110-14	1 mm	2 mm
18-3111-14	1.2 mm	2.2 mm
18-3112-14	1.5 mm	2.5 mm
18-3113-14	2 mm	3 mm

14.5 cm / 5 7/8"



**House Suction
Irrigating Tubes**

18-3115-00	5 French
18-3116-00	7 French
18-3117-00	8 French
18-3118-00	10 French
18-3119-00	12 French
18-3120-00	14 French

Ear suction tube



Baron

18-3125-00	3 French
18-3126-00	5 French
18-3127-00	7 French

With finger cut off



Baron

18-3130-00	3 French
18-3131-00	5 French
18-3132-00	7 French

Guide Needles
 Führungsnadeln
 Aguja de guía



- 18-3135-19** 8 Charr.
- 18-3136-19** 10 Charr.
- 18-3137-19** 12 Charr.
- 18-3138-19** 14 Charr.
- 18-3139-19** 16 Charr.
- 18-3140-19** 18 Charr.

Redon
 19.5 cm / 7 1/4"
 Slightly curved
 knife tip, threaded end



- 18-3145-19** 8 Charr.
- 18-3146-19** 10 Charr.
- 18-3147-19** 12 Charr.
- 18-3148-19** 14 Charr.
- 18-3149-19** 16 Charr.
- 18-3150-19** 18 Charr.

Redon
 19.5 cm / 5 1/2"
 Fully curved
 knife tip, threaded end



- 18-3155-19** 8 Charr.
- 18-3156-19** 10 Charr.
- 18-3157-19** 12 Charr.
- 18-3158-19** 14 Charr.
- 18-3159-19** 16 Charr.
- 18-3160-19** 18 Charr.

Redon
 19.5 cm / 7 1/4"
 Slightly curved
 lancet tip, threaded end



Standard
10-0231-03
No. 3
Solid



10-0231-05
No. 3
Solid, with scale



10-0231-04
No. 3
Solid



10-0213-04
No. 3
Plastics



10-0234-31
No. 3L
Solid straight



10-0234-35
No. 3L
Solid angled

Scalpel Handles
Skalpellgriffe
Mangos de bisturíes



Standard
10-0201-04
No. 4
Solid



10-3001-00
No. 4
Graduated in mm



10-0243-03
No. 4
Plastics



10-0205-45
No. 4L
Solid angled

10-0205-41
No. 4L
Solid straight



10-3005-00
No. 7
Long



10-0238-07
No. 7
Solid



10-0238-71
No. 7K
Solid



10-3010-00
No. 5
Solid



Collin
10-3015-00
13.5 cm / 5 1/4"
No. 8
Hollow



Collin
10-3020-00
14.5 cm / 5 3/4"
No. 9
Hollow



10-3025-00
No. 10
Hollow

Scalpel Handles
Skalpellgriffe
Mangos de bisturios



10-0247-03
14.5 cm / 5 3/4"
No. 3
Solid, round, straight



10-0248-03
14 cm / 5 1/2"
No. 3
Solid round angled



10-0241-03
15.5 cm / 6"
No. 3
Round hollow handle
straight



10-2001-03
No. 3
Round hollow handle
angled



10-3030-15
15.5 cm / 6 1/4"
No. 3
Hollow golden handle

Razor Blade Holders (and Breakers)
Rasierklingenhalter und -brecher
Pinzas para sujetar y para romper hojas de afeitar



Troutman Chris
10-3035-10
10 cm / 4"
5.5 mm Ø



Troutman Chris
10-3040-10
10 cm / 4"
5.5 mm Ø



10-3045-11
11 cm / 4½"



Castroviejo
10-3050-13
13 cm / 5¼"
8 mm Ø

Operating Scissors
Chirurgische Scheren
Tijeras para cirugía

Add "SC" to the item code for Supercut



Standard

11-0201-10	10.5 cm / 4 1/4"
11-0201-11	11.5 cm / 4 1/2"
11-0201-13	13.0 cm / 5"
11-0201-14	14.5 cm / 5 1/2"
11-0201-15	15.5 cm / 6"
11-0201-16	16.5 cm / 6 1/2"
11-0201-18	18.5 cm / 7 1/4"
11-0201-20	20.0 cm / 8"

Standard

11-0203-10	10.5 cm / 4 1/4"
11-0203-11	11.5 cm / 4 1/2"
11-0203-13	13.0 cm / 5"
11-0203-14	14.5 cm / 5 1/2"
11-0203-15	15.5 cm / 6"
11-0203-16	16.5 cm / 6 1/2"
11-0203-18	18.5 cm / 7 1/4"
11-0203-20	20.0 cm / 8"

Standard

11-0205-10	10.5 cm / 4 1/4"
11-0205-11	11.5 cm / 4 1/2"
11-0205-13	13 cm / 5"
11-0205-14	14.5 cm / 5 1/2"
11-0205-15	15.5 cm / 6"
11-0205-16	16.5 cm / 6 1/2"
11-0205-18	18.5 cm / 7 1/4"
11-0205-20	20 cm / 8"

Add "SC" to the item code for Supercut



Standard

11-0206-11	11.5 cm / 4½"
11-0206-13	13.0 cm / 5"
11-0206-14	14.5 cm / 5½"
11-0206-15	15.5 cm / 6"
11-0206-16	16.5 cm / 6½"
11-0206-18	18.5 cm / 7¼"
11-0206-20	20.0 cm / 8"

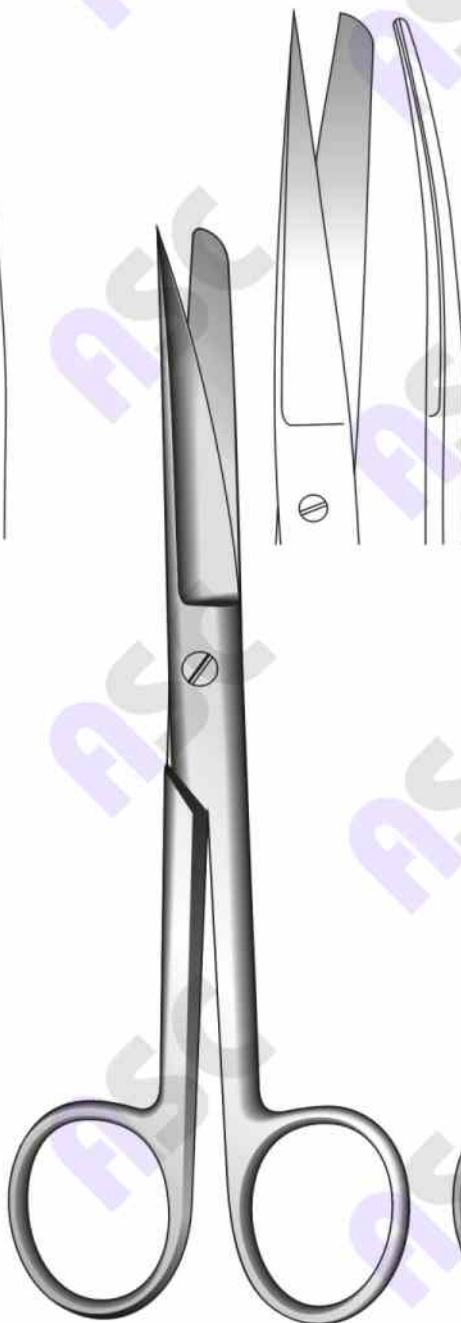

Standard

11-0208-11	11.5 cm / 4½"
11-0208-13	13.0 cm / 5"
11-0208-14	14.5 cm / 5½"
11-0208-15	15.5 cm / 6"
11-0208-16	16.5 cm / 6½"
11-0208-18	18.5 cm / 7¼"
11-0208-20	20.0 cm / 8"



Standard

11-0210-11	11.5 cm / 4½"
11-0210-13	13.0 cm / 5"
11-0210-14	14.5 cm / 5½"
11-0210-15	15.5 cm / 6"
11-0210-16	16.5 cm / 6½"
11-0210-18	18.5 cm / 7¼"
11-0210-20	20.0 cm / 8"

Operating Scissors
 Chirurgische Scheren
 Tijeras para cirugía

Add "SC" to the item code for Supercut



11-3030-14
 Straight

Deaver
 14 cm / 5½"



11-3031-14
 Curved

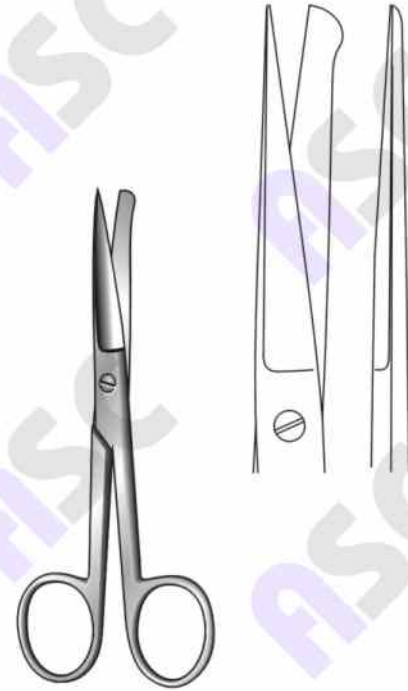

Incision
11-3035-13 13 cm / 5"
11-3035-14 14 cm / 5½"

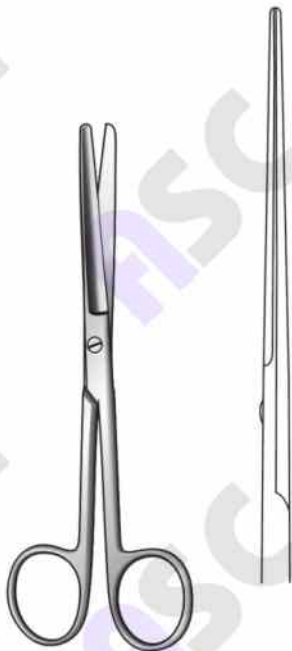

Graziol
11-3040-14 Blunt/Blunt
11-3041-14 Sharp/Blunt
11-3042-14 Sharp/Sharp
 14 cm / 5½"

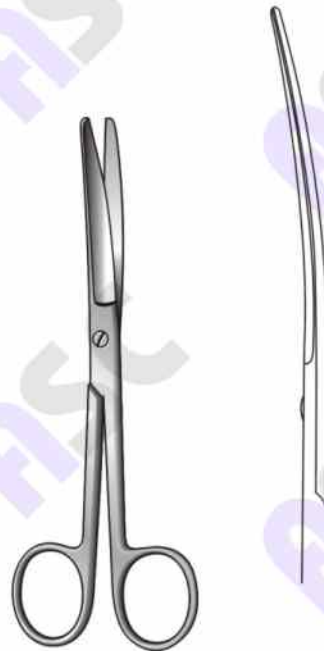

Graziol
11-3045-14 Blunt/Blunt
11-3046-14 Sharp/Blunt
11-3047-14 Sharp/Sharp
 14 cm / 5½"

Operating and Gynecological Scissors
Chirurgische und Gynäkologie Scheren
Tijeras para cirugía y ginecología

Add "SC" to the item code for Supercut



Mayo



Mayo Harrington



Mayo Stille

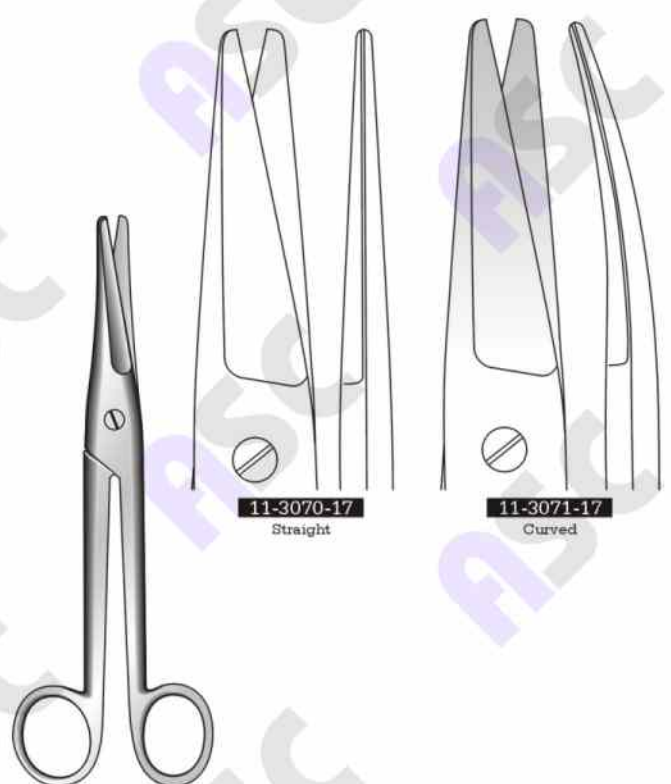

Mayo-Noble
17 cm / 6¾"

Operating and Gynecological Scissors
Chirurgische und Gynäkologie Scheren
Tijeras para cirugía y ginecología

Add "SC" to the item code for Supercut

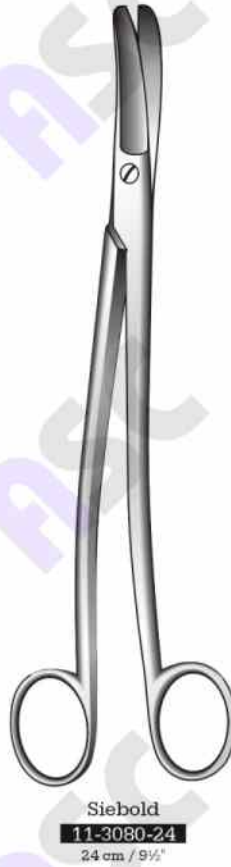
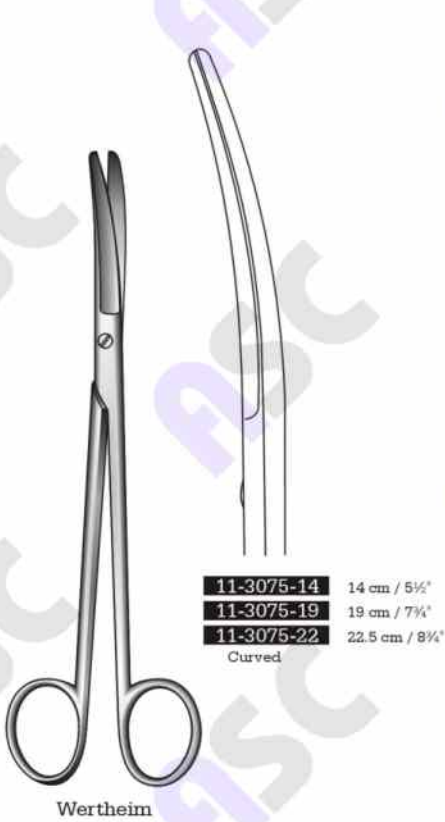

Dissecting Scissors
Präparierscheren
Tijeras para preparaciones

Add "SC" to the item code for Supercut

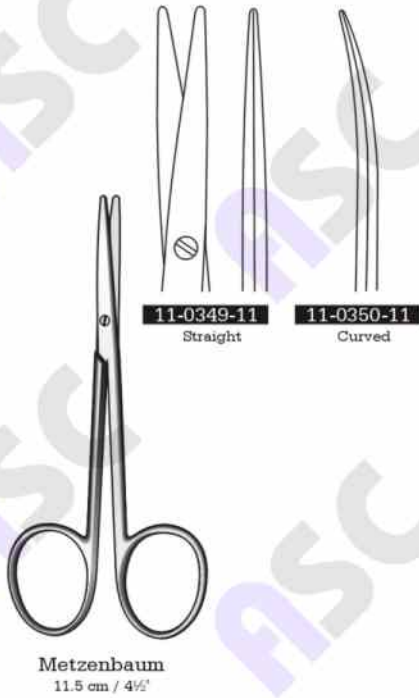

Dissecting Scissors
 Präparierscheren
 Tijeras para preparaciones

Add "SC" to the item code for Supercut

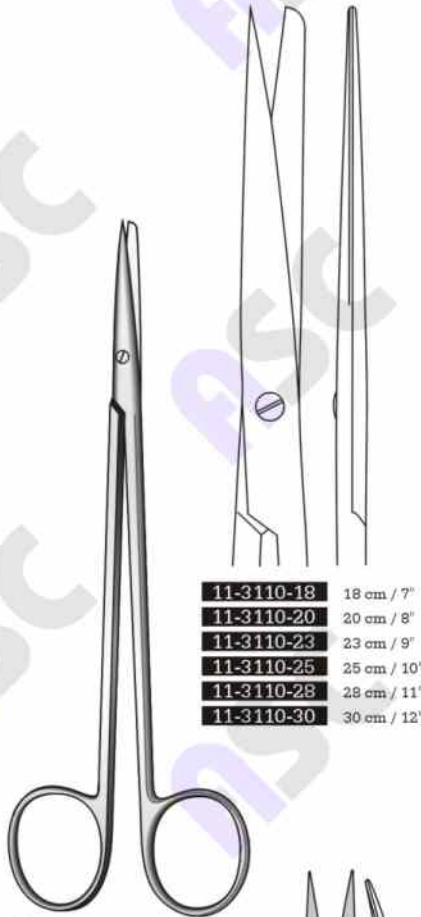

- 11-3110-18** 18 cm / 7"
- 11-3110-20** 20 cm / 8"
- 11-3110-23** 23 cm / 9"
- 11-3110-25** 25 cm / 10"
- 11-3110-28** 28 cm / 11"
- 11-3110-30** 30 cm / 12"

Metzenbaum-Nelson



- 11-3115-18** 18 cm / 7"
- 11-3115-20** 20 cm / 8"
- 11-3115-23** 23 cm / 9"
- 11-3115-25** 25 cm / 10"
- 11-3115-28** 28 cm / 11"
- 11-3115-30** 30 cm / 12"

Metzenbaum-Nelson



- 11-3120-18** 18 cm / 7"
- 11-3120-20** 20 cm / 8"
- 11-3120-23** 23 cm / 9"
- 11-3120-25** 25 cm / 10"
- 11-3120-28** 28 cm / 11"
- 11-3120-30** 30 cm / 12"

Metzenbaum-Nelson

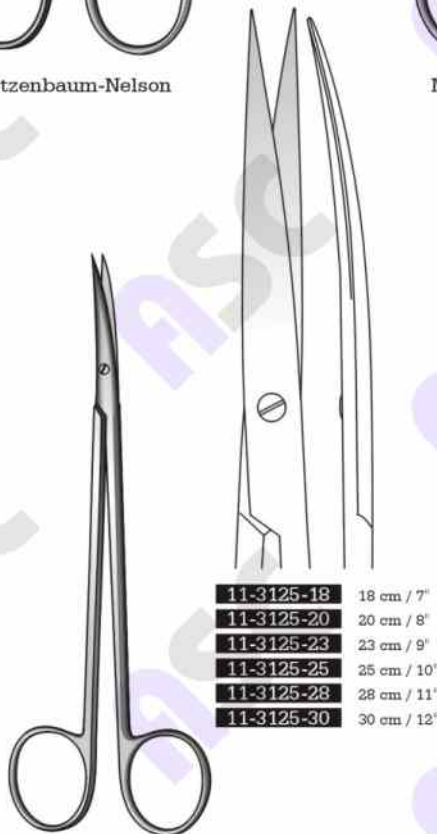

- 11-3125-18** 18 cm / 7"
- 11-3125-20** 20 cm / 8"
- 11-3125-23** 23 cm / 9"
- 11-3125-25** 25 cm / 10"
- 11-3125-28** 28 cm / 11"
- 11-3125-30** 30 cm / 12"

Metzenbaum-Nelson



- 11-3130-16** 16 cm / 6 1/4"
 - 11-3130-21** 21 cm / 8 1/2"
 - 11-3135-16**
- Straight Curved

Lexer

Dissecting Scissors, Fino-Line
Präparierscheren, Fino-Linie
Tijeras para preparación, Linea-fino

Add "SC" to the item code for Supercut

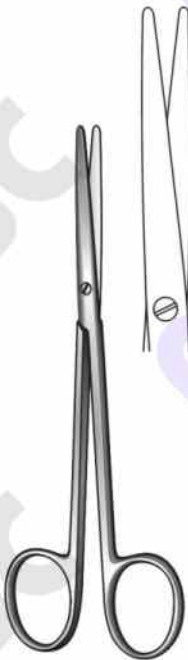

Metzenbaum-Fino

- 11-0427-14** 14.5 cm / 5½"
- 11-0427-18** 18 cm / 7"
- 11-0427-20** 20 cm / 8"
- 11-0427-23** 23 cm / 9"

Slender pattern

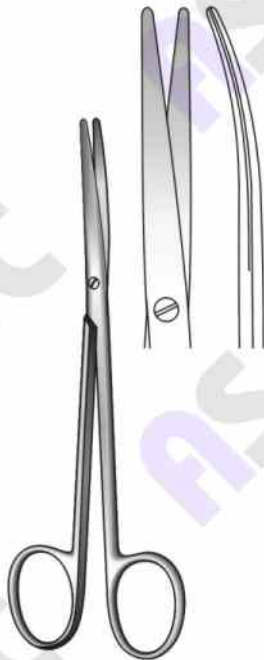

Metzenbaum-Fino

- 11-0428-14** 14.5 cm / 5½"
- 11-0428-18** 18 cm / 7"
- 11-0428-20** 20 cm / 8"
- 11-0428-23** 23 cm / 9"

Slender pattern

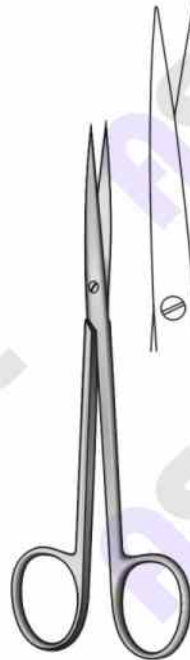

Metzenbaum-Fino

- 11-0429-14** 14.5 cm / 5½"
- 11-0429-18** 18 cm / 7"
- 11-0429-20** 20 cm / 8"
- 11-0429-23** 23 cm / 9"

Slender pattern

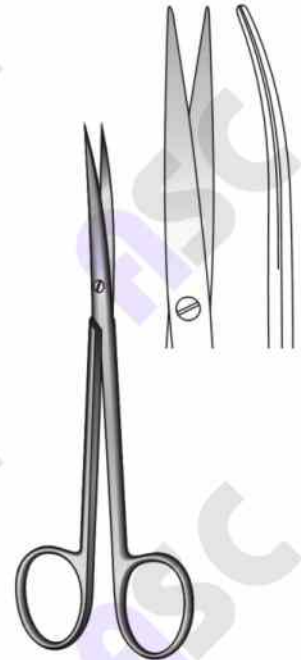

Metzenbaum-Fino

- 11-0430-14** 14.5 cm / 5½"
- 11-0430-18** 18 cm / 7"
- 11-0430-20** 20 cm / 8"
- 11-0430-23** 23 cm / 9"

Slender pattern

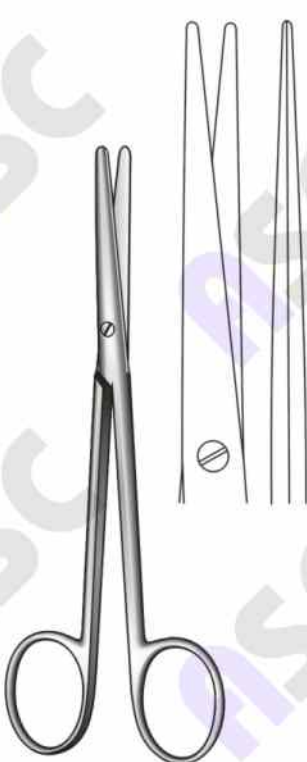

Lexer-Fino

- 11-3140-16**
- 16 cm / 6¼"
- Slender pattern

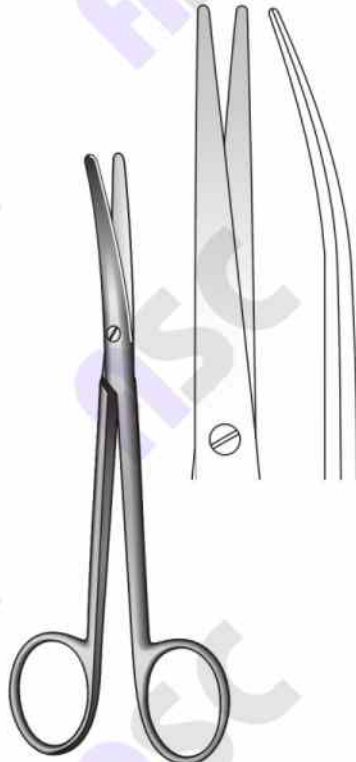

Lexer-Fino

- 11-3145-16**
- 16 cm / 6¼"
- Slender pattern



Lexer-Baby

- 10 cm / 4"



11-3150-10

Straight

11-3151-10

Curved

Thorax and Vascular Scissors
Thoraxscheren, Gefäßscheren
Tijeras torácicas y vasculares

Add "SC" to the item code for Supercut



De-Bakey
19 cm / 7½"

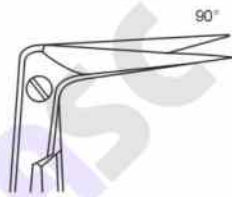

11-3154-19
Standard
11-3159-19
Delicate

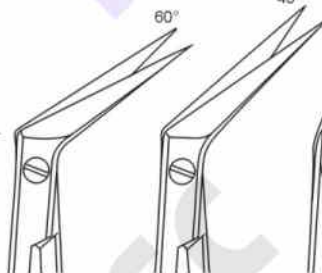

11-3155-19
Standard
11-3160-19
Delicate

11-3156-19
Standard
11-3161-19
Delicate

11-3157-19
Standard
11-3162-19
Delicate

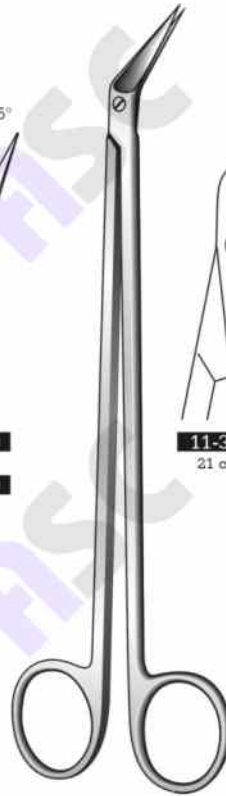

Potts de Martel



11-3165-21
21 cm / 8¼"



11-3165-24
24 cm / 9½"



Mc-Indoe
11-3170-19
19 cm / 7½"



11-3175-11
11.5 cm / 4½"



Dietrich



11-3180-18
11-3180-18B With ball pin
18 cm / 7"



11-3181-18
11-3181-18B With ball pin
18 cm / 7"

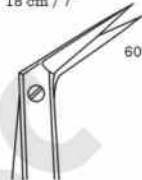

11-3182-17
11-3182-17B With ball pin
17.5 cm / 7"

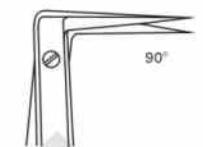

11-3183-17
11-3183-17B With ball pin
17 cm / 6¾"



11-3184-17
11-3184-17B With ball pin
17 cm / 6¾"

Thorax and Vascular Scissors
Thoraxscheren, Gefäßscheren
Tijeras torácicas y vasculares

Add "SC" to the item code for Supercut



Favaloro
11-3200-15
15 cm / 6"



De Bakey
11-3205-15
15.5 cm / 6"



De Bakey
11-3210-15
15.5 cm / 6"

Thorax and Vascular Scissors
Thoraxscheren, Gefäßscheren
Tijeras torácicas y vasculares

Add "SC" to the item code for Supercut



Crafoord
11-3215-30
30 cm / 12"



Satinsky
11-3220-24
24.5 cm / 10"



Klinkenbergh-Loth
11-3225-23
23 cm / 9"

Neurosurgical Scissors
Scheren für Neurochirurgie
Tijeras para neurocirugía

Add "SC" to the item code for Supercut



Thorek
11-3230-18
18 cm / 7"



Toennis
18 cm / 7"



Toennis-Adson
11-3240-17
17.5 cm / 7"

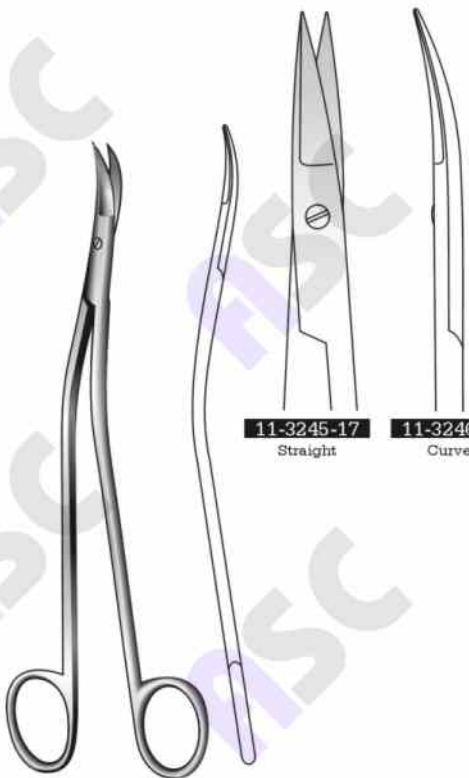

Dandy
17 cm / 6 3/4"



Schmieden-Taylor
11-3250-17
17 cm / 6 3/4"

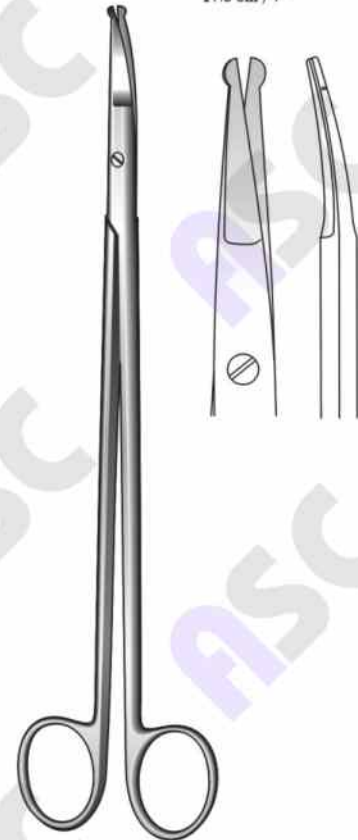

Strully
11-3255-22
22 cm / 8 1/2"
Curved

Tonsil and Nasal Scissors
 Tonsillen- und Nasenscheren
 Tijeras nasales y para amígdalas

Add "SC" to the item code for Supercut



Dean
 17 cm / 6 3/4"



11-0596-11
 Plain

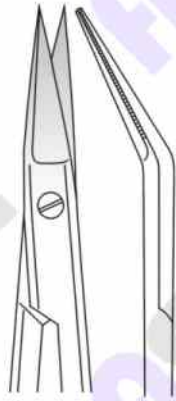

11-0598-17
 Serrated



Boettcher
 11-3260-18
 18 cm / 7"

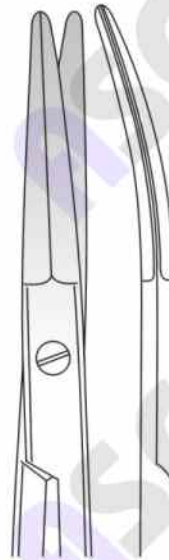

Heymann
 11-3265-18
 18 cm / 7"



Fomon
 11-3270-15
 15 cm / 6"



Cottle
 11-3275-16
 16 cm / 6 1/2"

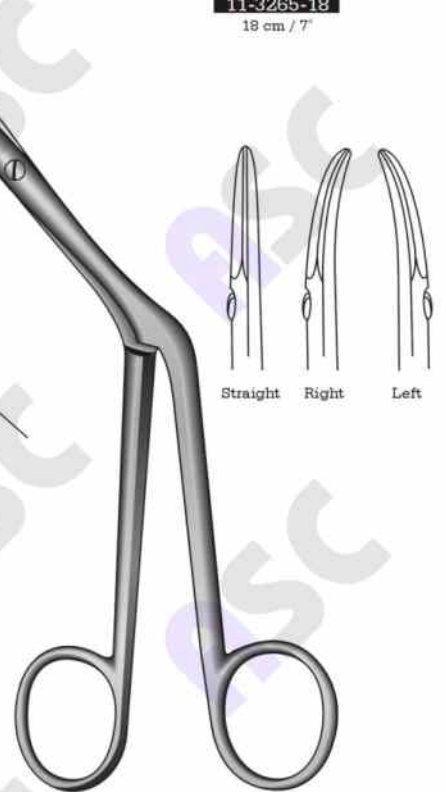

Knight
 11-3280-18 Straight
 11-3281-18 Curved left, serrated
 11-3282-18 Curved right, serrated
 18 cm / 7"

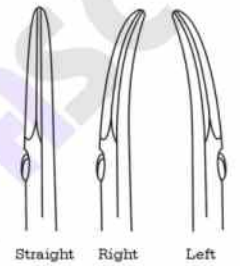

Episiotomy and Umbilical Scissors
Episiotomie- und Nabelschnurscheren
Tijeras para episiotomia y cordones umbilicales

Add "SC" to the item code for Supercut



Braun-Stadler
11-3285-14
14.5 cm / 5 7/8"
11-3285-18
18 cm / 7 1/4"



Braun-Stadler
11-3290-22
22 cm / 8 3/4"



Waldmann
11-3295-18
18 cm / 7 1/4"
One toothed cutting edge



Busch
11-3300-16 Straight
11-3301-16 Curved
16 cm / 6 1/4"



Schuhmacher
11-3305-06
15.5 cm / 6"



Modell USA
11-3310-10 10.5 cm / 4 1/4"
11-3310-12 12.5 cm / 5"

Fine Operating Scissors
Feine Chirurgische Scheren
Tijeras finas para cirugía

Add "SC" to the item code for Supercut



Fine Operating Scissors
Feine Chirurgische Scheren
Tijeras finas para cirugía

Add "SC" to the item code for Supercut



11 cm / 4 1/2"
Dissecting Scissors



11-3345-11
Straight



11-3346-11
Curved



Iris-Fine



11-3350-09 9 cm / 3 1/2"
11-3350-10 10.5 cm / 4 1/4"
Straight
Flat

11-3351-09 9 cm / 3 1/2"
11-3351-10 10.5 cm / 4 1/4"
Straight
Round



11-3355-09
11-3355-10
Curved
Flat

11-3356-09
11-3356-10
Curved
Round

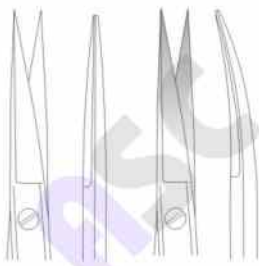

11-0731-11
11.5 cm / 4 1/2"
Flat

11-2030-11
11.5 cm / 4 1/2"
Round



11-0732-11
11.5 cm / 4 1/2"
Flat

11-2035-11
11.5 cm / 4 1/2"
Round



11-0734-11
11.5 cm / 4 1/2"
Flat

11-2036-11
9 cm / 3 1/2"
Round



11-0736-11
11.5 cm / 4 1/2"
Flat

11-2037-11
9 cm / 3 1/2"
Round



11-3360-11
11-3361-10
Strap

11-3362-10
With large rings



11-3365-11
11-3366-10
Strap

11-3367-10
With large rings



11-3370-11
11-3371-10
Blunt

11-3372-10
With large rings



11-3375-11
11-3376-10
Blunt

11-3377-10
With large rings



Iris



Steven

Fine Operating and Ligature Scissors
 Feine Chirurgische und Ligaturscheren
 Tijeras finas para cirugía y para ligaduras

Add "SC" to the item code for Supercut



Strabismus
11.5 cm / 4½"



11-3380-11
Straight



11-3381-11
Curved

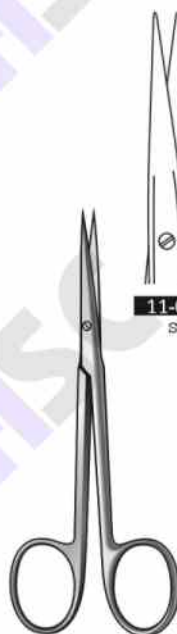

Kilner
11.5 cm / 4½"

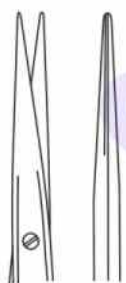

11-0695-11
Straight



11-0696-11
Curved

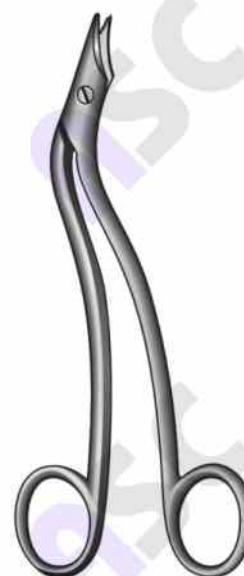

Heath-Stitch
11-3385-15
15 cm / 6"

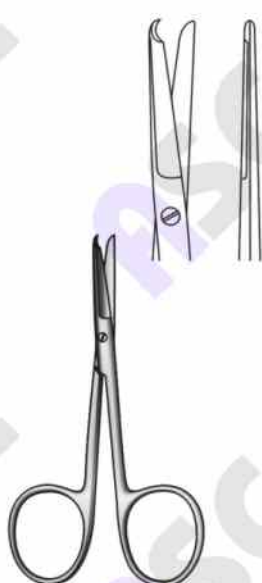

Spencer

- | | | |
|-------------------|------------------|-------------------|
| 11-0925-09 | Normal | 11-3395-11 |
| 11-3390-09 | Angled | 11-3396-11 |
| 11-3391-09 | Delicate | 11-3397-11 |
| 11-3392-09 | Delicate, Angled | 11-3398-11 |
| 9 cm / 3½" | | 11 cm / 4¼" |

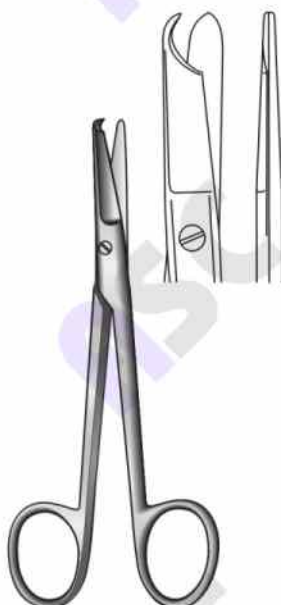

Spencer

- | | |
|-------------------|-----------|
| 11-0927-13 | Straight |
| 11-3400-13 | Side bend |
| 13 cm / 5" | |

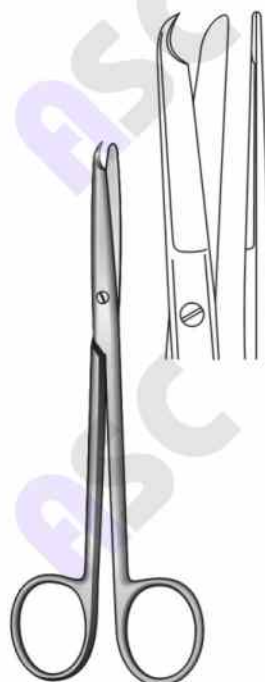

Littauer

- | |
|-------------------|
| 11-0935-14 |
| 14 cm / 5½" |



11-3406-11
11 cm / 4¼"
Fine angled
Suture scissors

11-3405-11

- | |
|----------------------------------|
| 11 cm / 4¼" |
| Fine straight
Suture scissors |

Fine Operating Scissors (Ribbon Type)
Feine Chirurgische Scheren
Tijeras finas para cirugía

Add "SC" to the item code for Supercut



Iris
11-3410-10
10 cm / 4"
Straight
Standard pattern, ribbon type



Iris
11-3415-10
10 cm / 4"
Curved
Standard pattern, ribbon type



Utility
11-3420-10
10 cm / 4"
Curved
Blunt blade 15 mm
long, ribbon type



Iris
11-3425-10
10 cm / 4"
Straight with 14 mm blades
Miniature pattern, ribbon type



Iris
11-3430-10
10 cm / 4"
Curved with 14 mm blades
Miniature pattern, ribbon type



Stevens-Gradle
11-3435-10 Sharp/Sharp, straight
11-3436-10 Blunt/Blunt, straight
11-3437-10 Sharp/Sharp, curved
11-3438-10 Blunt/Blunt, curved
10 cm / 3 1/4"
Ribbon Tenotomy scissor

Fine Operating Gum and Ligature Scissors
Feine Chirurgische und Zahnfleischscheren
Tijeras finas para cirugía y encías

Add "SC" to the item code for Supercut



Wagner
12 cm / 4 7/8"



11-0671-12
Straight



11-0672-12
Curved

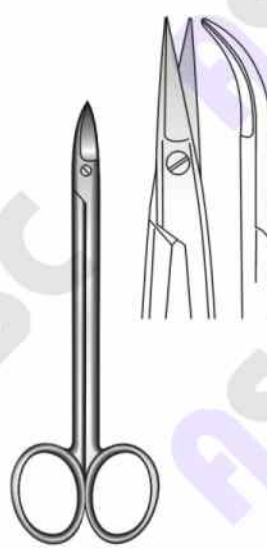

Quinby
11-3440-12
12.5 cm / 5"

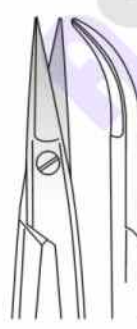

Neumann
11-3445-12
12 cm / 4 7/8"



Harvey
11-0963-12
12.5 cm / 5"
Serrated

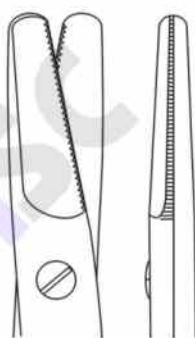

Goldman-Fox
13 cm / 5"

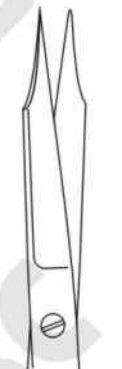

11-0667-13
Straight

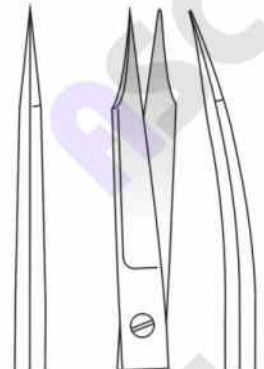

11-0668-13
Curved

Add "SC" to the item code for Supercut

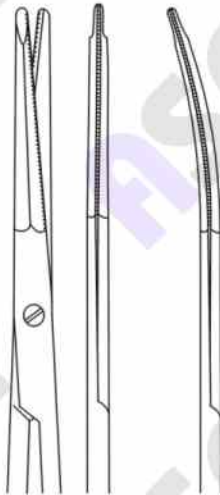

11-3450-11

11.5 cm / 4½"

11-3450-14

14 cm / 5½"

Straight



11-3455-11

11.5 cm / 4½"

11-3455-14

14 cm / 5½"

Curved



11-3460-15

15 cm / 6"

11-3460-18

18 cm / 7"

Straight



11-3465-15

15 cm / 6"

11-3465-18

18 cm / 7"

Curved

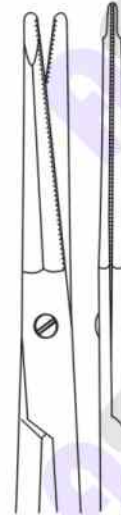

11-3470-18

Straight



11-3471-18

Curved



Gregory
Toothed



Kaye
Toothed



Stella-S
18 cm / 7"
S-shaped
Toothed

Face-Lift Scissors
 Face-Lift-Scheren
 Tijeras para face-lift

Add "SC" to the item code for Supercut

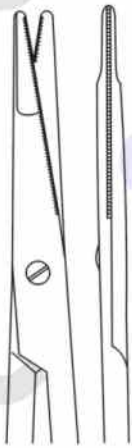

11-3475-18
 Straight



11-3476-18
 Curved

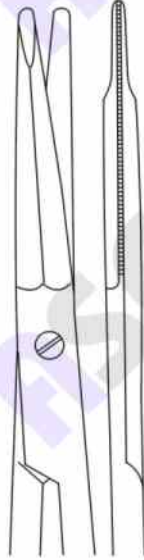

11-3480-18
 Straight



11-3481-18
 Curved

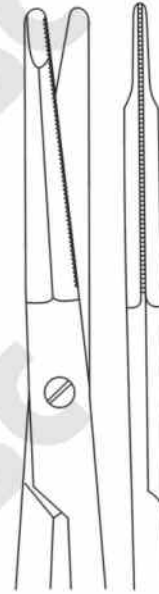

11-3485-23
 Straight



11-3486-23
 Curved



Gorney
 18 cm / 7"
 Toothed



Freeman-Kaye
 18 cm / 7"
 Toothed



Freeman
 23 cm / 9"
 Toothed

Fine Operating Gum and Ligature Scissors
Feine Chirurgische und Zahnfleischscheren
Tijeras finas para cirugía y encías

Add "SC" to the item code for Supercut



Crown-Beebee



11-0971-10
10 cm / 4"
Straight



11-0972-10
10 cm / 4"
Curved



11-0975-10
12 cm / 4 1/4"
1 Blade saw edge
Straight

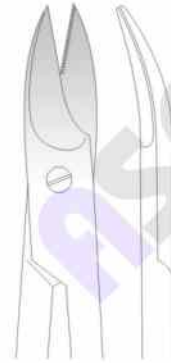

11-0976-10
12 cm / 4 1/4"
1 Blade saw edge
Curved



Universal
11-0966-12
12 cm / 4 1/2"
Serrated



Lockin
11-0708-16
16 cm / 6 1/4"



11-0706-16
16 cm / 6 1/4"



Enterotomy, Nail Splitting Scissors
Darmscheren, Nagelspaltscheren
Tijeras para hender unas y enterotomos

Add "SC" to the item code for Supercut

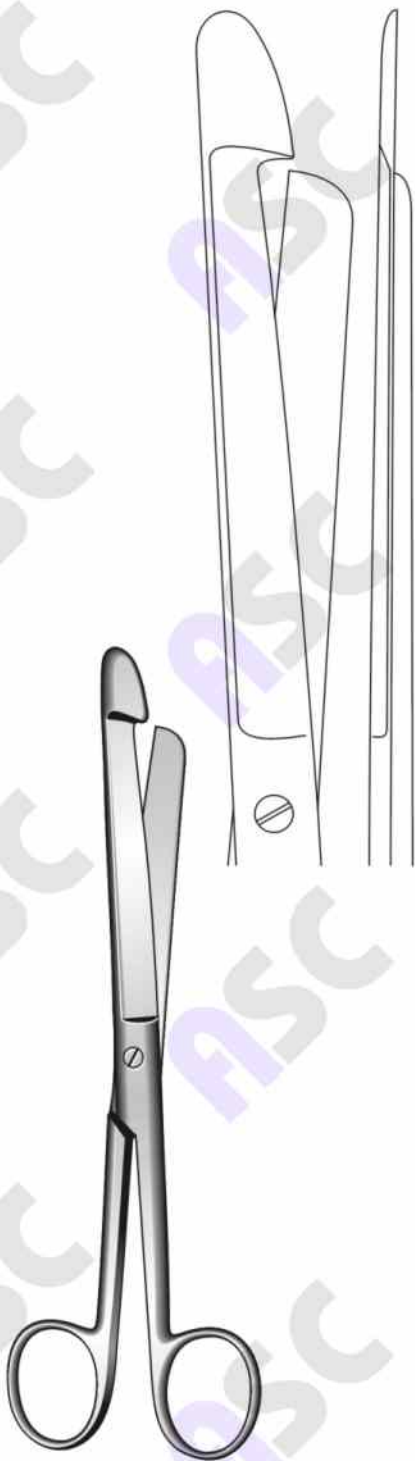

11-3490-21
21 cm / 8½"

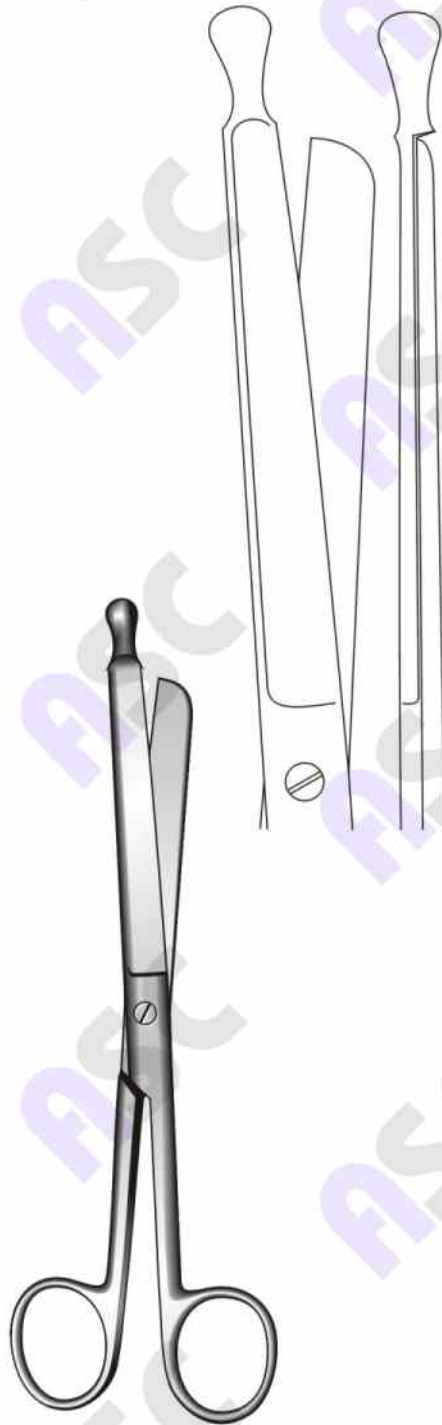

11-3495-21
21 cm / 8½"
Enterotomy, postmortem and
nail splitting scissors

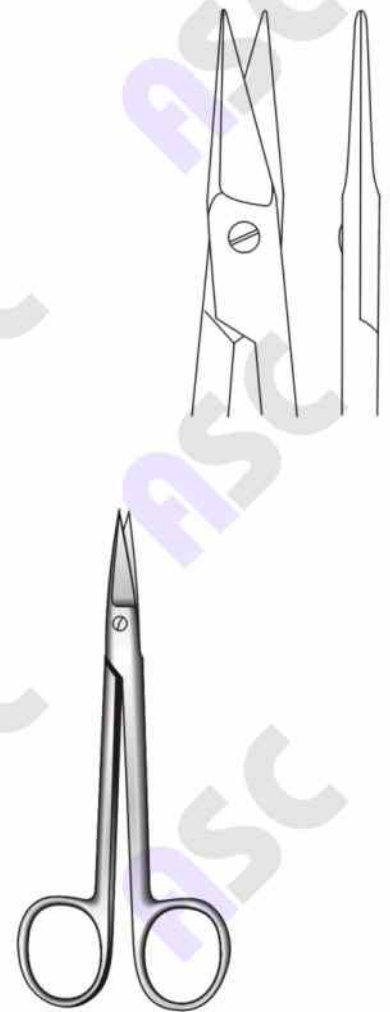

Systrunk
11-3500-13
13 cm / 5"



Westcott
11.5 cm / 4½"



11-3505-11 11-3506-11



11-3510-09
9 cm / 3½"



11-3515-11
11 cm / 4½"



11-3520-12
12 cm / 5"

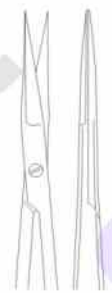

11-3525-09
9 cm / 3½"



Micro Scissors
Mikroscheren
Micro tijeras



11-0874-00
14 cm / 5½"



11-0874-01
15.5 cm / 6"



11-0874-02
15.5 cm / 6"
1 Blade saw edge



11-3530-18
Straight



11-3531-18
Curved



11-3532-18
Angled



11-3535-18
25°

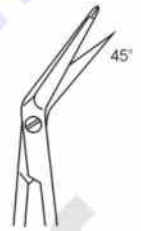

11-3536-18
45°



11-3537-18
60°



11-3538-18
90°



11-3539-18
125°

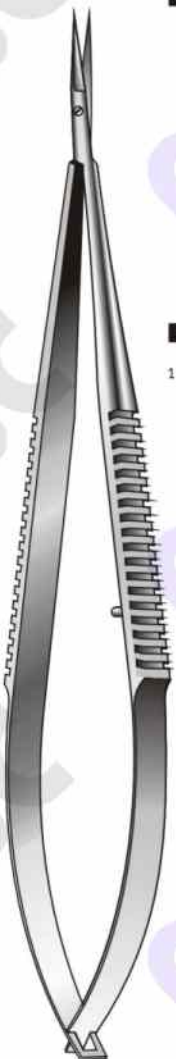

Reill

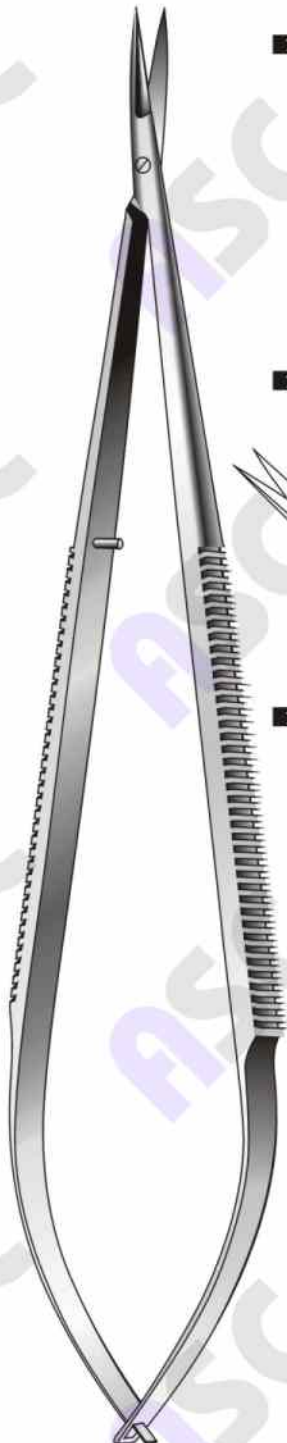

18.5 cm / 7½"



18 cm / 7"



18 cm / 7"



18.5 cm / 7 1/4"



Micro Scissors
Mikro Scheren
Micro tijeras



Jacobson Potts
22.5 cm / 8 7/8"

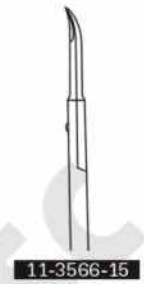
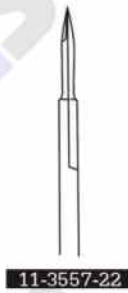

15.5 cm / 6"



15.5 cm / 6"



Add "SC" to the item code for Supercut



- | | |
|-----------------------|-------------|
| 21-2001-14 | Black |
| 21-2002-14 | Red |
| 21-2003-14 | Blue |
| 21-2004-14 | Yellow |
| 21-2005-14 | Orange |
| 21-2006-14 | Bright pink |
| 14.5 cm / 5 3/4" | |
| Suprcut not available | |



- | | |
|-----------------------|-------------|
| 21-0310-18 | Black |
| 21-2010-18 | Red |
| 21-2011-18 | Blue |
| 21-2012-18 | Yellow |
| 21-2013-18 | Orange |
| 21-2014-18 | Bright pink |
| 18 cm / 7" | |
| Suprcut not available | |



- Knowles**
- | | |
|----------------|----------|
| 21-0261-14 | Straight |
| 21-2020-14 | Angled |
| 14 cm / 5 1/2" | |



- Lister**
- | | | |
|------------|----------------|-------------|
| 21-0266-09 | 9 cm / 3 1/2" | 11-3570-09T |
| 21-0266-11 | 11 cm / 4 1/4" | 11-3570-11T |
| 21-0266-14 | 14 cm / 5 1/2" | 11-3570-14T |
| 21-0266-16 | 16 cm / 6 1/4" | 11-3570-16T |
| 21-0266-18 | 18 cm / 7" | 11-3570-18T |
| 21-0266-20 | 20 cm / 8" | 11-3570-20T |



- Esmarch**
- | | |
|------------|----------------|
| 21-0306-20 | 20 cm / 8" |
| 21-0306-22 | 22 cm / 8 3/4" |



- Bergmann**
- | | |
|------------|------------|
| 21-0296-23 | 23 cm / 9" |
|------------|------------|



- Bruns**
- | | | |
|-------------|----------|------------------|
| 21-0398-24 | Plain | 23.5 cm / 9 1/4" |
| 21-2025-24T | Serrated | 24 cm / 9 1/2" |

Scissors with Tungsten Carbide Inserts
Scheren mit Hartmetalleinsätzen
Tijeras con filos de carburo de tungsteno



11-3580-14T 14.5 cm / 5 1/2"
11-3580-16T 16 cm / 6 1/4"
11-3580-18T 18 cm / 7"

Straight



11-3585-14T
11-3585-16T
11-3585-18T

Curved

Standard

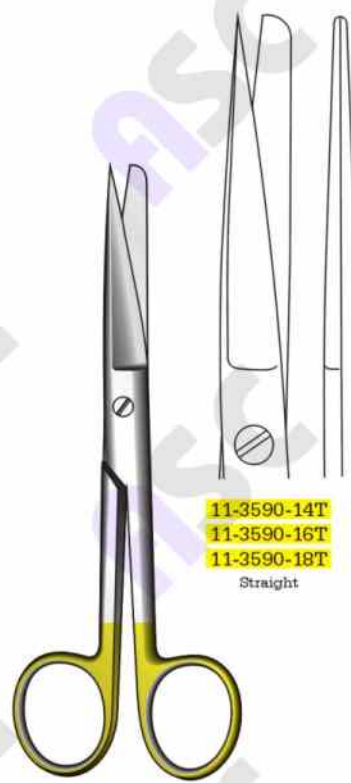

11-3590-14T 14.5 cm / 5 1/2"
11-3590-16T 16 cm / 6 1/4"
11-3590-18T 18 cm / 7"

Straight



11-3595-14T
11-3595-16T
11-3595-18T

Curved

Standard



11-3600-14T 14.5 cm / 5 1/2"
11-3600-16T 16 cm / 6 1/4"
11-3600-18T 18 cm / 7"

Straight



11-3605-14T
11-3605-16T
11-3605-18T

Curved

Standard



11-3610-14T 14.5 cm / 5 1/2"
11-3610-17T 17 cm / 6 3/4"
11-3610-23T 23 cm / 9"

Straight



11-3615-14T
11-3615-17T
11-3615-23T

Curved

Mayo

Scissors with Tungsten Carbide Inserts
Scheren mit Hartmetalleinsätzen
Tijeras con filos de carburo de tungsteno



Mayo-Stille



11-3620-15T 15 cm / 6"
11-3620-17T 17 cm / 6 3/4"
Straight



11-3625-15T
11-3625-17T
Curved



Lexer

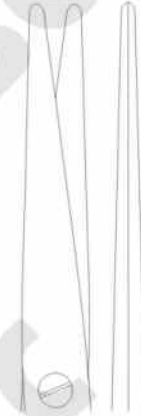

11-3630-16T 16 cm / 6 1/2"
11-3630-21T 21 cm / 8 1/4"
Straight



11-3635-16T
11-3635-21T
Curved



Mayo-Lexer
16 cm / 6 1/4"



11-3640-16T
Straight



11-3641-16T
Curved



Metzenbaum



11-3645-10T 10 cm / 4"
11-3645-12T 12 cm / 4 3/4"
Straight



11-3650-10T
11-3650-12T
Curved

Scissors with Tungsten Carbide Inserts
Scheren mit Hartmetalleinsätzen
Tijeras con filos de carburo de tungsteno



Scissors with Tungsten Carbide Inserts
Scheren mit Hartmetalleinsätzen
Tijeras con filos de carburo de tungsteno



Metzenbaum-Fino
S-Shape

11-1068-18T	18 cm / 7"	11-1069-18T
11-1068-20T	20 cm / 8"	11-1069-20T
11-1068-23T	23 cm / 9"	11-1069-23T
	Straight	Curved



Metzenbaum-Fino
S-Shape

11-1070-18T	18 cm / 7"	11-1071-18T
11-1070-20T	20 cm / 8"	11-1071-20T
11-1070-23T	23 cm / 9"	11-1071-23T
	Straight	Curved



Metzenbaum-Thorek

11-3665-20T	20 cm / 8"
11-3665-23T	23 cm / 9"
11-3665-28T	28 cm / 11"



Toennis-Adson

11-3670-17T	17 cm / 6 3/4"
-------------	----------------

Scissors with Tungsten Carbide Inserts
Scheren mit Hartmetalleinsätzen
Tijeras con filos de carburo de tungsteno



11-3675-14T
14.5 cm / 5 3/4"

Metzenbaum-Lahey

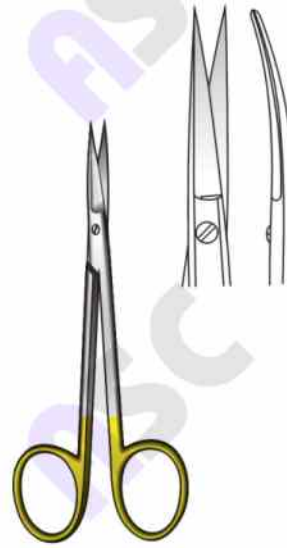

Iris
11-1085-11T Straight
11-1086-11T Curved
11.5 cm / 4 1/2"

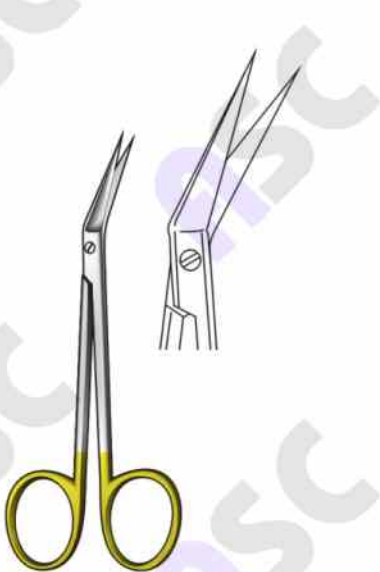

11-1090-11T Straight
11-2045-13T Curved
13 cm / 5"

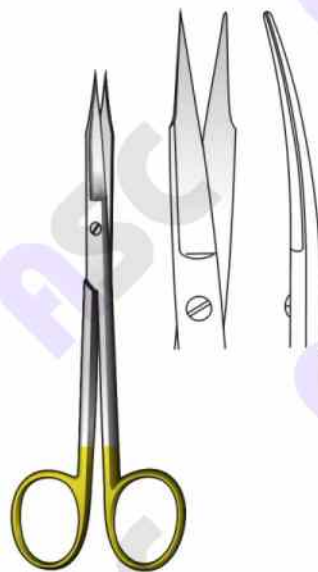

Goldman-Fox
11-1081-13T Straight
11-1082-13T Curved
13 cm / 5"

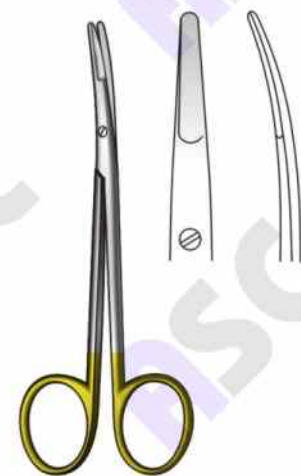

Ragnell (killner)
11-1095-12T
12 cm / 4 3/4"

Scissors with Tungsten Carbide Inserts
Scheren mit Hartmetalleinsätzen
Tijeras con filos de carburo de tungsteno



11-1100-16T
Straight

Kelly
16 cm / 6 1/4"

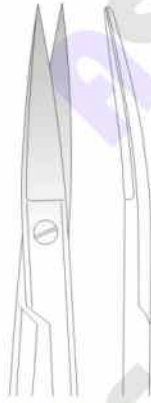

11-1105-16T
Curved



11-1115-17T
17 cm / 6 3/4"
Saw edge
S-shaped

Dean



11-1120-16T
16 cm / 6 1/4"
Saw edge

Locklin



11-1125-16T
16 cm / 6 1/4"
Saw edge

Locklin

Scissors with Tungsten Carbide Inserts
Scheren mit Hartmetalleinsätzen
Tijeras con filos de carburo de tungsteno



Mayo-Harrington
11-3680-28T Straight
11-3681-28T Curved
28 cm / 11"

Sims
11-3685-20T Straight
11-3686-20T Curved
20 cm / 8"

Parametrium
23 cm / 9"

11-3690-23T Curved
11-3691-23T Full Curved

Scissors with Tungsten Carbide Inserts
Scheren mit Hartmetalleistzen
Tijeras con filos de carburo de tungsteno



Potts-Smith



Fomon
11-3705-15T
15 cm / 6"

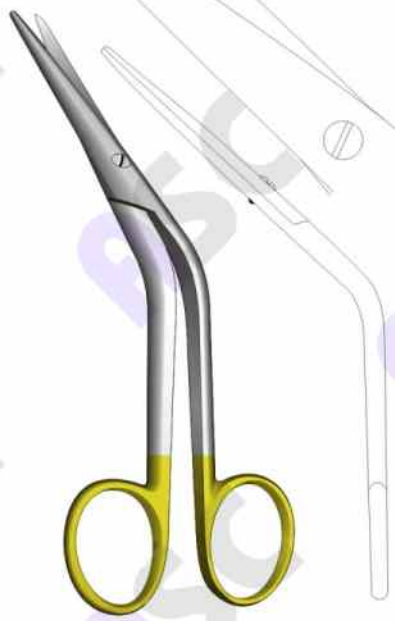

Cottle
11-3710-16T
16 cm / 6½"



Knight Nasal Scissors
18 cm / 7"

Face-Lift Scissors
Face-Lift-Scheren
Tijeras para face-lift

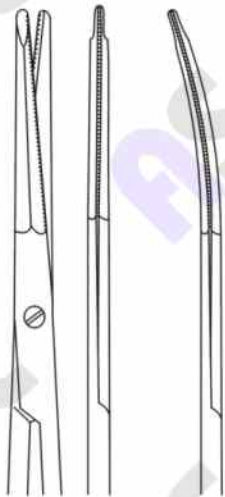

11-3745-11T
11.5 cm / 4½"
11-3745-14T
14 cm / 5½"
Straight

11-3746-11T
11.5 cm / 4½"
11-3746-14T
14 cm / 5½"
Curved

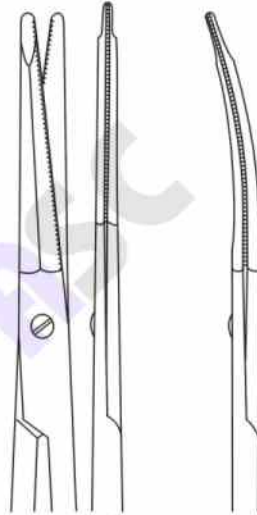

11-3750-15T
15 cm / 6"
11-3750-18T
18 cm / 7"
Straight

11-3751-15T
15 cm / 6"
11-3751-18T
18 cm / 7"
Curved

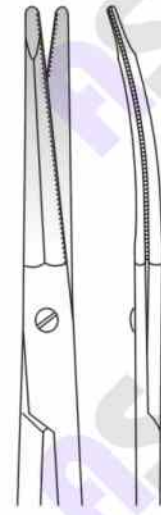

11-3755-18T
18 cm / 7"
S-shaped
Curved



Gregory
Toothed



Kaye
Toothed



Stella-S
Toothed

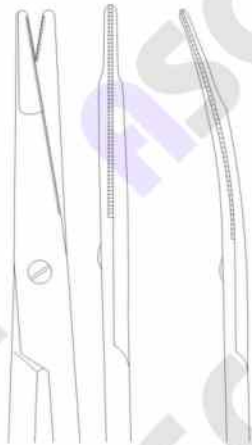

11-3760-18T

Straight

11-3761-18T

Curved

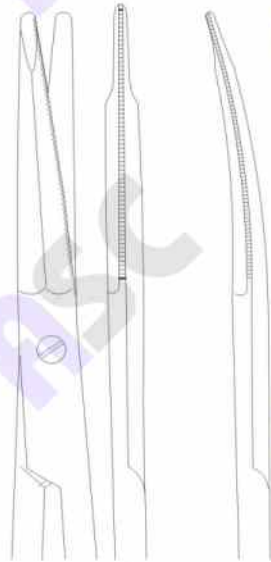

11-3765-18T

Straight

11-3766-18T

Curved

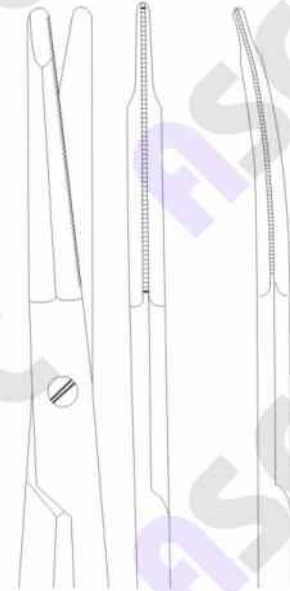

11-3770-23T

Straight

11-3771-23T

Curved



Gorney
18 cm / 7"
Toothed



Freeman-Kaye
18 cm / 7"
Toothed



Freeman
23 cm / 9"
Toothed

Dressing and Tissue Forceps
Anatomische und Chirurgische Pinzetten
Pinzas de disección con dientes



**English
T.O.E**

12-3001-12	12.5 cm / 5"
12-3001-15	15 cm / 6"
12-3001-18	18 cm / 7"
12-3001-20	20 cm / 8"



English

12-3005-12	12.5 cm / 5"
12-3005-15	15 cm / 6"
12-3005-18	18 cm / 7"

B/end



Treves

12-3010-12	12.5 cm / 5"	12-3015-12
12-3010-15	15 cm / 6"	12-3015-15
12-3010-18	18 cm / 7"	12-3015-18

1:2 teeth
2:3 teeth



Standard

12-0201-10	10 cm / 4"
12-0201-11	11.5 cm / 4½"
12-0201-13	13 cm / 5"
12-0201-14	14.5 cm / 5½"
12-0201-16	16 cm / 6¼"
12-0201-18	18 cm / 7"
12-0201-20	20 cm / 8"
12-0201-23	23 cm / 9"
12-0201-25	25 cm / 10"
12-0201-30	30 cm / 12"



Standard Narrow

12-0221-10	
12-0221-11	
12-0221-13	
12-0221-14	
12-0221-16	
12-0221-18	
12-0221-20	
12-0221-23	
12-0221-25	
12-0221-30	



Tissue

12-0402-10	10 cm / 4"
12-0402-11	11.5 cm / 4½"
12-0402-13	13 cm / 5"
12-0402-14	14.5 cm / 5½"
12-0402-16	16 cm / 6¼"
12-0402-18	18 cm / 7"
12-0402-20	20 cm / 8"
12-0402-23	23 cm / 9"
12-0402-25	25 cm / 10"
12-0402-30	30 cm / 12"

1:2 Teeth



Tissue

12-3020-10	
12-3020-11	
12-3020-13	
12-3020-14	
12-3020-16	
12-3020-18	
12-3020-20	
12-3020-23	
12-3020-25	
12-3020-30	

2:3 Teeth



Dressing and Tissue Forceps
Anatomische und Chirurgische Pinzetten
Pinzas de disección con dientes



Tissue

- 12-3025-13** 13 cm / 5"
 - 12-3025-14** 14.5 cm / 5½"
 - 12-3025-16** 16 cm / 6¼"
- 3-4 Teeth



Tissue

- 12-3030-13** 13 cm / 5"
 - 12-3030-14** 14.5 cm / 5½"
 - 12-3030-16** 16 cm / 6¼"
- 4-5 Teeth



USA Standard Model

- 12-3035-10** 10 cm / 4"
- 12-3035-13** 13 cm / 5"
- 12-3035-14** 14.5 cm / 5½"
- 12-3035-15** 15.5 cm / 6"
- 12-3035-18** 18 cm / 7"
- 12-3035-21** 21 cm / 8¼"
- 12-3035-25** 25 cm / 10"
- 12-3035-31** 31 cm / 12¼"



USA Standard Narrow

- 12-3040-12** 12 cm / 4¾"
- 12-3040-13** 13 cm / 5"
- 12-3040-14** 14.5 cm / 5½"
- 12-3040-15** 16 cm / 6"



USA Model

- 12-3045-12** 12 cm / 4¾"
 - 12-3045-13** 13 cm / 5"
 - 12-3045-14** 14.5 cm / 5½"
 - 12-3045-15** 15.5 cm / 6"
 - 12-3045-18** 18 cm / 7"
 - 12-3045-21** 21 cm / 8¼"
 - 12-3045-25** 25 cm / 10"
 - 12-3045-31** 31 cm / 12¼"
- 1:2 Teeth



Stille

- 12-3050-15**
15 cm / 6"



Stille

- 12-3055-15**
15 cm / 6"
1:2 Teeth



Stille

- 12-3060-15**
15 cm / 6"
2:3 Teeth

Dressing and Tissue Forceps
Anatomische und Chirurgische Pinzetten
Pinzas de disección con dientes



12-3065-13 13 cm / 5"
12-3065-14 14.5 cm / 5½"
12-3065-16 16 cm / 6¼"
Cross Serrated



Adson



12-0269-12 12 cm / 4¾"
12-0269-15 15 cm / 6"



Adson
1.2 Teeth

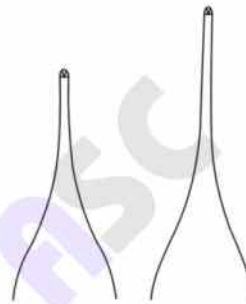

12-0469-12 12 cm / 4¾"
12-0469-15 15 cm / 6"



McIndoe
12-0271-15
12-2001-15
15 cm / 6"
1.2 Teeth



Gillies
12-0471-15
15 cm / 6"
1:2 Teeth



Lane
12-3075-12 12.5 cm / 5"
12-3075-15 15 cm / 6"
12-3075-18 18 cm / 7"
12-3075-20 20 cm / 8"
1:2 Teeth
12-3080-12 12.5 cm / 5"
12-3080-15 15 cm / 6"
12-3080-18 18 cm / 7"
12-3080-20 20 cm / 8"
2:3 Teeth



Waugh
Cross serration fine

12-3085-15 15 cm / 6"
12-3085-18 18 cm / 7"
12-3085-20 20 cm / 8"

12-3090-15 15 cm / 6"
12-3090-18 18 cm / 7"
12-3090-20 20 cm / 8"
1:2 teeth



Semken

12-3095-12
12.5 cm / 5"

12-3095-15
15 cm / 6"



Semken
1:2 Teeth

12-3100-12
12.5 cm / 5"

12-3100-15
15 cm / 6"

Dressing and Tissue Forceps
Anatomische und Chirurgische Pinzetten
Pinzas de disección con dientes



Potts-smith
12-3105-18 18 cm / 7"
12-3105-21 21 cm / 8¼"
12-3105-25 25 cm / 10"



Potts-smith
12-3110-18 18 cm / 7"
12-3110-21 21 cm / 8¼"
12-3110-25 25 cm / 10"
 1:2 Teeth



12-3115-17
Straight

Cushing
17.5 cm / 7"



12-3116-17
Curved



Cushing
12-3120-17 Straight
12-3121-17 Curved
 17 cm / 6¾"
 1:2 Teeth



Taylor
12-3125-17
 17 cm / 6¾"



Taylor
12-3130-17
 17 cm / 6¾"
 1:2 Teeth



Taylor
12-3135-17
 17 cm / 6¾"



Taylor
12-3140-17
 17 cm / 6¾"
 1:2 Teeth

Dressing and Tissue Forceps
 Anatomische und Chirurgische Pinzetten
 Pinzas de disección con dientes



Taylor
12-0357-18
 18.5 cm / 7 1/4"



Taylor
12-3145-17
 17.5 cm / 7"
 1:2 Teeth



Gerald
 Serrated
 18 cm / 7"



12-0424-18
 Straight



12-0444-18
 Curved



Gerald
 17 cm / 6 3/4"
 1:2 Teeth



12-0487-17
 Straight



12-0488-17
 Curved



T-Forceps
12-3150-18
 18 cm / 7"
 Tip 17 mm



Brophy
12-3155-20
12-3156-20
 20 cm / 8"



Straight
 Curved



Brophy
12-3160-20
 20 cm / 8"
 1:2 Teeth



Stone
12-3165-15
 15 cm / 6"
 4:5 Teeth



Lerche
12-3170-15
 15 cm / 6"
 5:6 Teeth



Dressing, Tissue and Grasping Forceps
Anatomische und Chirurgische Pinzetten
Pinzas de disección con dientes



Duehrssen
12-3175-20
20 cm / 8"



Wangenstein
12-3180-23
23 cm / 9"



Nelson
12-3185-23
23 cm / 9"



Singley-Tuttle
12-3190-23
23 cm / 9"



Russ-Modell
12-3195-15 15 cm / 6"
12-3195-20 20 cm / 8"
12-3195-25 25 cm / 10"



Mayo-Russ
12-3200-23
23 cm / 9"



Tissue and Grasping Forceps
Chirurgische- und Fassungszetten
Pinzas de diseuion con dientes



Durante



12-3205-14
14.5 cm / 5 1/2"



12-3205-16
16 cm / 6 1/4"



12-3205-20
20 cm / 8"



Bonney
18 cm / 7"



12-3210-18
1:2 Teeth



12-3211-18
2:3 Teeth



Ferris-Smith
18 cm / 7"



12-3215-18
1:2 Teeth



12-3216-18
2:3 Teeth



Duval
12-3220-14
14.5 cm / 5 1/2"



Collin-Duval
12-3225-20 14 mm
12-3226-20 25 mm
20 cm / 8"



Micro Forceps, Splinter Forceps
Micro Pinzetten, Splitter Pinzetten
Micro-pinzas, Pinzas para espinas



Micro-Adson
12-0505-12
12 cm / 4 1/4"



Micro-Adson
12-3230-12
12-3231-12
12 cm / 4 1/4"
With platform



Adson-Brown
12-0501-12
12 cm / 4 1/4"
7:7 Teeth



Iris
11.5 cm / 4 1/2"



12-3235-11



12-3236-11



12-3237-11



12-3245-07
7.5 cm / 3"



12-3245-09
9 cm / 3 1/2"



12-3240-11
1:2 Teeth



12-3241-11
1:2 Teeth



12-3242-11
1:2 Teeth



12-3245-11
11.5 cm / 4 1/2"



Feilchenfeld



12-3250-12
12.5 cm / 5"

Splinter Forceps
Splitter Pinzetten
Pinzas para espinas



12-3255-10 12-3256-10



12-3260-10 12-3261-10



Hunter
10.5 cm / 4 1/4"



Walter-Carmalt
10.5 cm / 4 1/4"



12-3265-12
12 cm / 4 3/4"



Shaaf
12-3270-09
9 cm / 3 1/2"



Peet
12-0826-11
11.5 cm / 4 1/2"

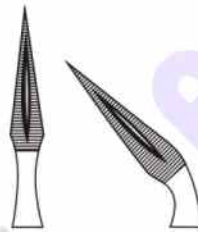

12-0821-13 12-0822-13



Stieglitz
13.5 cm / 5 1/4"

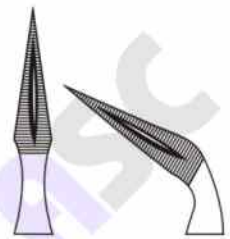

12-0841-15 12-0842-15



Ralk
15 cm / 6"

Jeweller Type Forceps
Uhrmacher Pinzetten
Pinzas de relojeros



12-3275-11
11.5 cm / 4½"
0.2 mm
Fig. 7



12-3280-11
11.5 cm / 4½"
0.4 mm
1:2 Teeth



12-3285-13
13.5 cm / 5¼"
0.3 mm
Fig. 3



12-3290-11
11 cm / 4¼"
0.4 mm
1:2 Teeth



12-3295-11
11 cm / 4¼"
0.2 mm
Fig. 4



12-3300-11
11 cm / 4¼"
0.15 mm
Fig. 5



12-3305-11
11 cm / 4¼"
0.3 mm

Cilia Forceps
Cilienpinzetten
Pinzas depilatorias



Littauer
12-3310-08
8.5 cm / 3 1/2"
Smooth jaw



12-3315-09
9 cm / 3 1/2"



Douglas
12-3320-09
9 cm / 3 1/2"



Douglas
12-3325-09
9 cm / 3 1/2"



Beer
12-3330-09
9 cm / 3 1/2"
Smooth jaw



Gradle
12-3335-09
9.5 cm / 3 3/4"



Henry
12-3340-12
12 cm / 4 3/4"



Barraquer
12-3345-10
10.5 cm / 4 1/4"
Smooth jaw

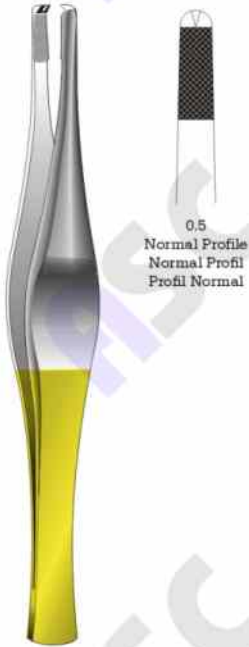

Ferris Smith
12-3350-18T
18 cm / 7"



Gerald
17 cm / 6 1/2"



Mc Indoe
12-0339-15T
15 cm / 6"



Potts-Smith



Bonney
17 cm / 6 1/2"



Normal Profile
Normal Profil
Profil Normal



Gillies
12-0337-15T
15 cm / 6"



Dissecting Forceps
Pinzetten
Pinzas de disección



Oehler

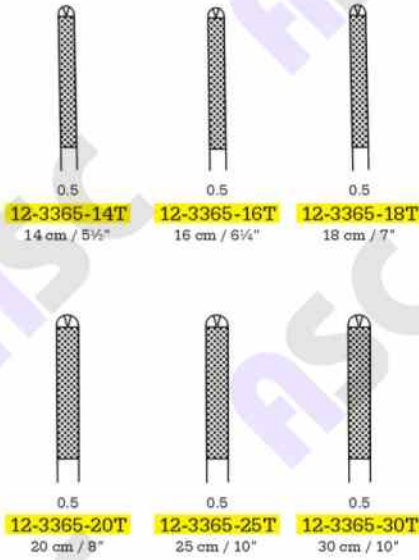

Normal Profile
Normal Profil
Profil Normal



Standard

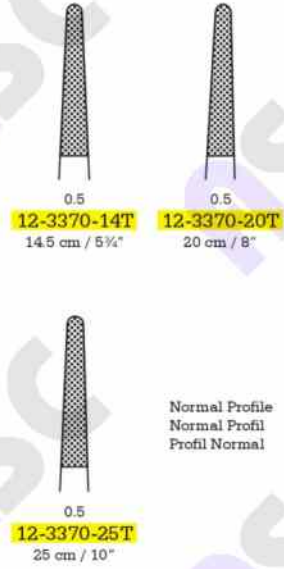

Normal Profile
Normal Profil
Profil Normal



Adson

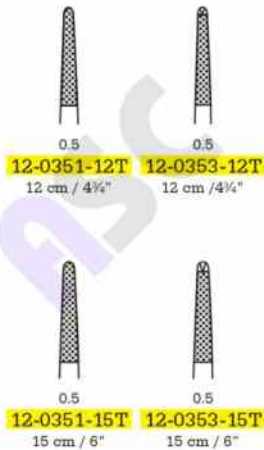

Normal Profile
Normal Profil
Profil Normal



Micro Adson



Mini Profile
Mini Profil
Profil Mini



Adson Brown
12-0345-12T
12 cm / 4¾"





0.5
12-0355-17T 17.5 cm / 6 7/8"
12-0355-20T 20 cm / 8"
12-0355-25T 25 cm / 10"
 Normal Profile
 Normal Profil
 Profil Normal

Cushing



Cushing
12-0356-18T
 18 cm / 7"



0.5
 Normal Profile
 Normal Profil
 Profil Normal



0.5
 Normal Profile
 Normal Profil
 Profil Normal

Cushing-Taylor
12-0357-18T
 18 cm / 7"



0.5
12-0341-16T 16 cm / 6 1/4"
12-0341-18T 18 cm / 7"
 Normal Profile
 Normal Profil
 Profil Normal

0.4
12-0343-16T 16 cm / 6 1/4"
12-0343-18T 18 cm / 7"
 Mini Profile
 Mini Profil
 Profil Mini

Semken



Smooth
 Giett
 Lisas

12-3375-15T
 15 cm / 6"



0.2
12-3380-15T 15 cm / 6"
12-3380-19T 19 cm / 7 1/2"
12-3380-24T 24 cm / 9 1/2"
 Micro Profile
 Mikro Profil
 Profil Micro

0.4
12-3381-15T 15 cm / 6"
12-3381-19T 19 cm / 7 1/2"
12-3381-24T 24 cm / 9 1/2"
 Mini Profile
 Mini Profil
 Profil Mini

De Bakkey

Dissecting Forceps
Pinzetten
Pinzas de disección



Mini Profile
Mini Profil
Profil Mini

Gruenwald
12-3385-18T
18 cm / 7"



Wangenstein

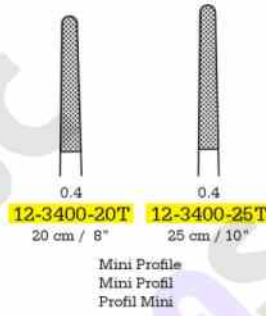
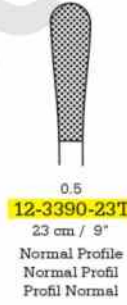

12-3405-23T
23 cm / 9"

Bulldog Clamps
Bulldogklemmen
Clamps Bulldog



13-3001-03
3.5 cm / 1 3/8"



13-3005-03
3.5 cm / 1 3/8"



13-3010-04
4.5 cm / 1 3/4"



13-3015-04
4.5 cm / 1 3/4"



Dieffenbach
13-3020-03 3.8 cm / 1 1/2"
13-3020-04 4.8 cm / 2"



Dieffenbach
13-3025-03
13-3025-04



Dieffenbach
13-3030-05
5.8 cm / 2 1/4"



Dieffenbach
13-3035-05
5.8 cm / 2 1/4"



Johns-Hopkins
13-3040-05 5 cm / 2"
13-3040-06 6.5 cm / 2 1/2"
13-3040-07 7.5 cm / 3"



13-3045-05
13-3045-06
13-3045-07

Artery Forceps
Arterienklemmen
Pinzas hemostáticas



Halsted-Mosquito
Normal



Normal

13-3050-09	9 cm / 3½"
13-0407-10	10 cm / 4"
13-3050-12	12 cm / 4¾"
13-0411-12	12.5 cm / 5"
13-3050-18	18 cm / 7"
13-3050-20	21 cm / 8¼"



Normal

13-3051-09	9 cm / 3½"
13-0408-10	10 cm / 4"
13-3051-12	12 cm / 4¾"
13-0412-12	12.5 cm / 5"
13-3051-18	18 cm / 7"
13-3051-20	21 cm / 8¼"



Normal

13-3052-09	9 cm / 3½"
13-3052-10	10 cm / 4"
13-3052-12	12 cm / 4¾"
13-0413-12	12.5 cm / 5"
13-3052-18	18 cm / 7"
13-3052-20	21 cm / 8¼"

1:2 Teeth



Normal

13-3053-09	9 cm / 3½"
13-3053-10	10 cm / 4"
13-3053-12	12 cm / 4¾"
13-0415-12	12.5 cm / 5"
13-3053-18	18 cm / 7"
13-3053-20	21 cm / 8¼"

1:2 Teeth



Micro-Mosquito



Micro

13-3055-09	9 cm / 3½"
13-0421-10	10 cm / 4"
13-0421-12	12 cm / 4¾"



Micro

13-3056-09	9 cm / 3½"
13-0422-10	10 cm / 4"
13-0422-12	12 cm / 4¾"



Micro

13-3057-09	9 cm / 3½"
13-0423-10	10 cm / 4"
13-0423-12	12 cm / 4¾"

1:2 Teeth



Micro

13-3058-09	9 cm / 3½"
13-0424-10	10 cm / 4"
13-0424-12	12 cm / 4¾"

1:2 Teeth

Artery Forceps
Arterienklemmen
Pinzas hemostáticas



Mosquito
Extra extra micro

13-3060-09	9 cm / 3½"
13-3060-10	10 cm / 4"
13-3060-12	12 cm / 4¾"

Straight

13-3061-09	
13-3061-10	
13-3061-12	

Curved



Providence-Hospital
14 cm / 5½"

13-0425-14	13-0426-14
Straight	Curved



Carrel
13-3065-10
10 cm / 4"



Terrier
13-3070-10
10 cm / 4"
1:2 Teeth



Terrier
13-3075-12
12 cm / 4¾"

Artery Forceps
Arterienklemmen
Pinzas hemostáticas

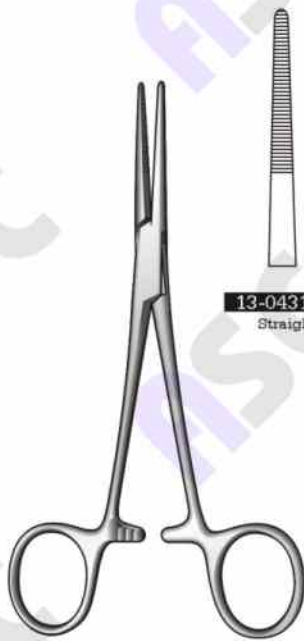

Kelly
14 cm / 5½"



13-0431-14
Straight



13-0432-14
Curved



Kelly-Rankin



13-0435-16
16 cm / 6¼"

13-3080-18
18 cm / 7"
Straight

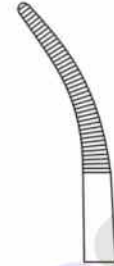

13-0436-16
16 cm / 6¼"

13-3081-18
18 cm / 7"
Curved



Crile
14 cm / 5½"

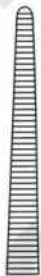

13-0441-14



13-0442-14

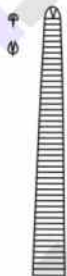

13-3085-14
1:2 Teeth

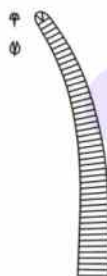

13-3086-14
1:2 Teeth



Crile-Rankin



13-0447-16
16 cm / 6¼"

13-3095-18
18 cm / 7"



13-0448-16
16 cm / 6¼"

13-3096-18
18 cm / 7"



13-3090-16
16 cm / 6¼"

13-3097-18
18 cm / 7"
1:2 Teeth



13-3091-16
16 cm / 6¼"

13-3098-18
18 cm / 7"
1:2 Teeth

Artery Forceps
Arterienklemmen
Pinzas hemostáticas



Kelly
14 cm / 5½"
Delicate

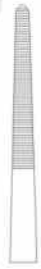

13-3100-14
Straight



13-3101-14
Curved



Kelly-Rankin
Delicate



13-3105-16
16 cm / 6¼"
13-3105-18
18 cm / 7"
Straight



13-3106-16
16 cm / 6¼"
13-3106-18
18 cm / 7"
Curved



Crile
14 cm / 5½"
Delicate



13-3110-14



13-3111-14



13-3112-14
1:2 Teeth



13-3113-14
1:2 Teeth



Crile-Rankin
Delicate



13-3115-16
16 cm / 6¼"
13-3120-18
18 cm / 7"



13-3116-16
16 cm / 6¼"
13-3121-18
18 cm / 7"



13-3117-16
16 cm / 6¼"
13-3122-18
18 cm / 7"
1:2 Teeth



13-3118-16
16 cm / 6¼"
13-3123-18
18 cm / 7"
1:2 Teeth

Artery Forceps
Arterienklemmen
Pinzas hemostáticas

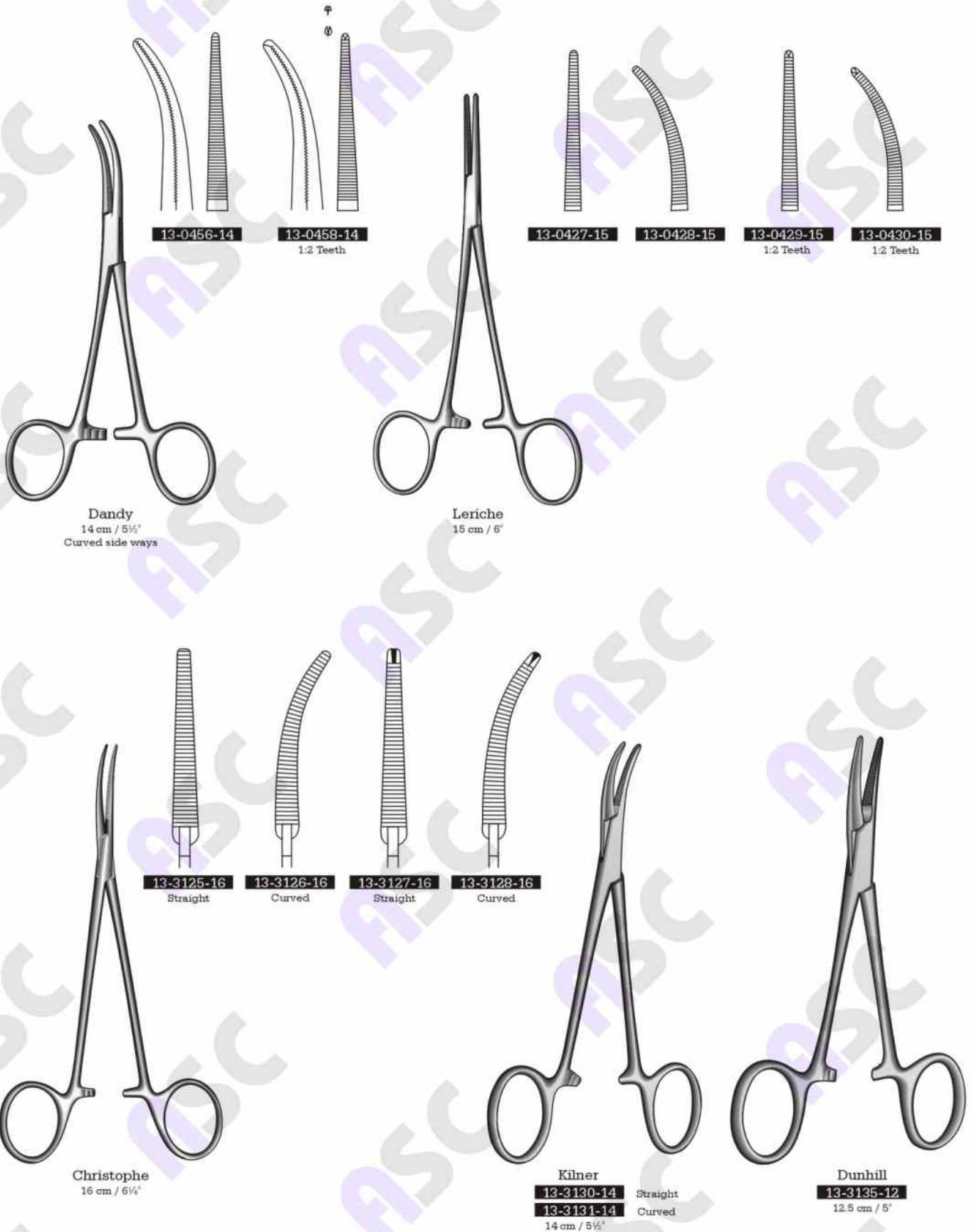

Artery Forceps
Arterienklemmen
Pinzas hemostáticas



Grey-Turner

13-3140-15 Straight

13-3141-15 Curved

15 cm / 6"

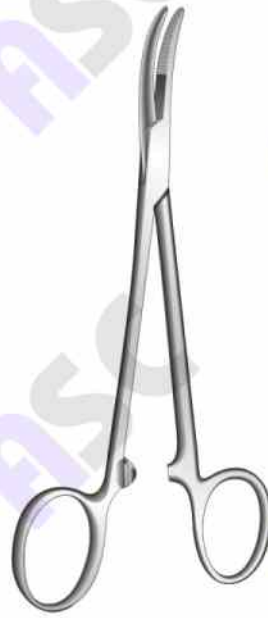

Cairns

13-3145-14 Straight

13-3146-14 Curved

14.5 cm / 5 3/4"

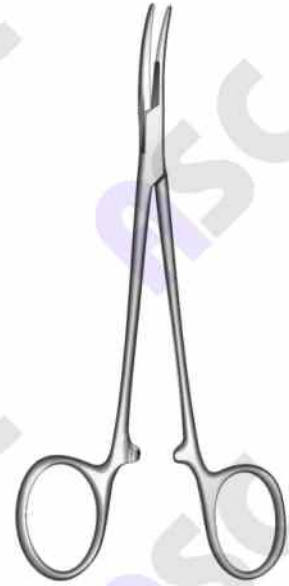

Cushing

13-3150-14 Straight

13-3151-14 Curved

14.5 cm / 5 3/4"



13-3155-18

Straight

13-3156-18

Curved

Birkett

18.5 cm / 7 1/4"



Pean

13-3160-12 12.5 cm / 5"

13-3160-14 14 cm / 5 1/2"

13-3160-16 16 cm / 6 1/4"

Straight

13-3161-12

13-3161-14

13-3161-16

Curved

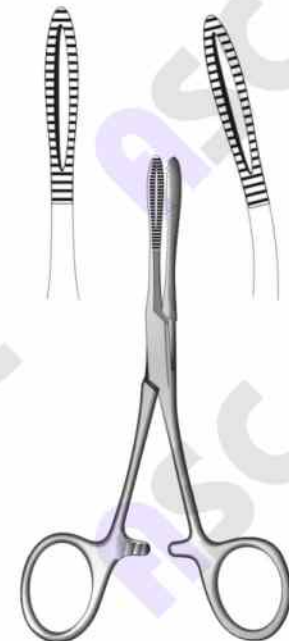

Kroenlien

13-3165-14 Straight

13-3166-14 Curved

14 cm / 5 1/2"

Artery Forceps
Arterienklemmen
Pinzas hemostáticas



13-3169-12	12.5 cm / 5"
13-3169-15	15 cm / 6"
13-3169-18	18 cm / 7"
13-3169-20	20 cm / 8"
13-3169-23	23 cm / 9"

Straight

13-3170-12	12.5 cm / 5"
13-3170-15	15 cm / 6"
13-3170-18	18 cm / 7"
13-3170-20	20 cm / 8"
13-3170-23	23 cm / 9"

Curved



13-3173-12	12.5 cm / 5"
13-3173-15	15 cm / 6"
13-3173-18	18 cm / 7"
13-3173-20	20 cm / 8"
13-3173-23	23 cm / 9"

Straight

13-3174-12	12.5 cm / 5"
13-3174-15	15 cm / 6"
13-3174-18	18 cm / 7"
13-3174-20	20 cm / 8"
13-3174-23	23 cm / 9"

Curved



13-3177-12	12.5 cm / 5"
13-3177-15	15 cm / 6"
13-3177-18	18 cm / 7"
13-3177-20	20 cm / 8"

Straight

13-3178-12	12.5 cm / 5"
13-3178-15	15 cm / 6"
13-3178-18	18 cm / 7"
13-3178-20	20 cm / 8"

Curved



Spencerwells



Spencerwells



Jones

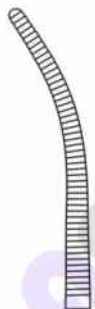

13-3180-13	13.5 cm / 5 1/4"
13-3180-14	14.5 cm / 5 3/4"
13-3180-17	17 cm / 6 3/4"

13-3181-13	
13-3181-14	
13-3181-17	



Pean



13-3183-13	13 cm / 5"
13-3183-14	14 cm / 5 1/2"
13-3183-16	16 cm / 6 1/4"

1:2 Teeth

13-3184-13	
13-3184-14	
13-3184-16	

1:2 Teeth



Kocher

Artery Forceps
Arterienklemmen
Pinzas hemostáticas



13-0511-14	14 cm / 5½"	13-0512-14
13-0511-16	16 cm / 6¼"	13-0512-16
13-0511-18	18 cm / 7"	13-0512-18
13-0511-20	20 cm / 8"	13-0512-20
13-0511-22	22 cm / 8¾"	13-0512-22
13-0511-24	24 cm / 9½"	13-0512-24
13-0511-26	26 cm / 10½"	13-0512-26
13-0511-30	30 cm / 12"	13-0512-30
Straight		Curved

Rochester-Pean

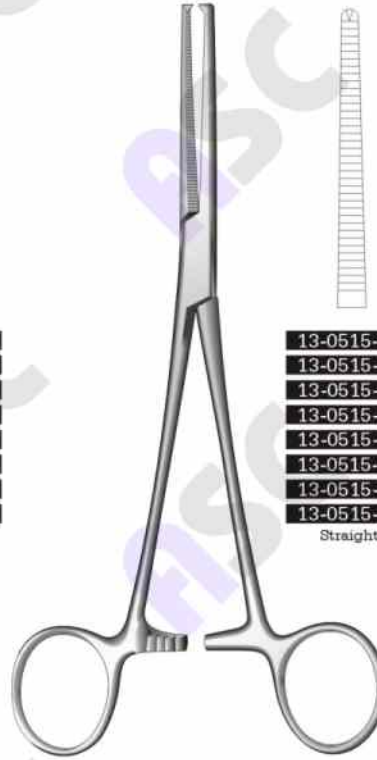

13-0515-14	14 cm / 5½"	13-0516-14
13-0515-16	16 cm / 6¼"	13-0516-16
13-0515-18	18 cm / 7"	13-0516-18
13-0515-20	20 cm / 8"	13-0516-20
13-0515-22	22 cm / 8¾"	13-0516-22
13-0515-24	24 cm / 9½"	13-0516-24
13-0515-26	26 cm / 10½"	13-0516-26
13-0515-30	30 cm / 12"	13-0516-30
Straight		Curved

Rochester-Ochsner



13-3186-14	14 cm / 5½"	13-3187-14
13-3186-16	16 cm / 6¼"	13-3187-16
13-3186-18	18 cm / 7"	13-3187-18
13-3186-20	20 cm / 8"	13-3187-20
13-3186-22	22 cm / 8¾"	13-3187-22
13-3186-24	24 cm / 9½"	13-3187-24
13-3186-26	26 cm / 10½"	13-3187-26
13-3186-30	30 cm / 12"	13-3187-30
Straight		Curved

Rochester-Pean
Delicate



13-3190-14	14 cm / 5½"	13-3191-14
13-3190-16	16 cm / 6¼"	13-3191-16
13-3190-18	18 cm / 7"	13-3191-18
13-3190-20	20 cm / 8"	13-3191-20
13-3190-22	22 cm / 8¾"	13-3191-22
13-3190-24	24 cm / 9½"	13-3191-24
13-3190-26	26 cm / 10½"	13-3191-26
13-3190-30	30 cm / 12"	13-3191-30
Straight		Curved

Rochester-Ochsner
Delicate

Artery Forceps
Arterienklemmen
Pinzas hemostáticas



Pean-Nippon

- | | | |
|------------|------------------|------------|
| 13-3193-14 | 14.5 cm / 5 7/8" | 13-3194-14 |
| 13-3193-16 | 16.5 cm / 6 1/2" | 13-3194-16 |
| 13-3193-18 | 18.5 cm / 7 1/4" | 13-3194-18 |



Kocher-Nippon
1:2 Teeth

- | | | |
|------------|------------------|------------|
| 13-3197-14 | 14.5 cm / 5 7/8" | 13-3198-14 |
| 13-3197-16 | 16.5 cm / 6 1/2" | 13-3198-16 |
| 13-3197-18 | 18.5 cm / 7 1/4" | 13-3198-18 |



Dixon-Lovelace
16 cm / 6 1/4"

13-3200-16

13-3201-16
1:2 Teeth



Heiss
20 cm / 8"

13-3203-01

13-3203-02

13-3203-03



13-3204-01
1:2 Teeth

13-3204-02
1:2 Teeth



Artery Forceps
Arterienklemmen
Pinzas hemostáticas



Adson
18 cm / 7"



13-3205-18 13-3206-18 13-3207-18 13-3208-18



Rochester-Carmalt

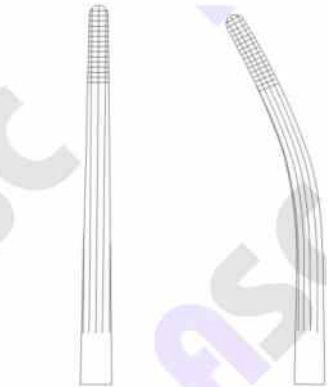

13-3210-16 16 cm / 6 1/4" 13-3211-16
13-3210-20 20 cm / 8" 13-3211-20
Straight Curved



Bengolea

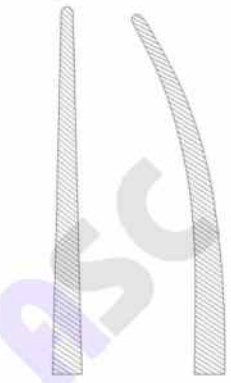

13-3212-20 13-3213-20
13-3212-26 13-3213-26
Straight Curved

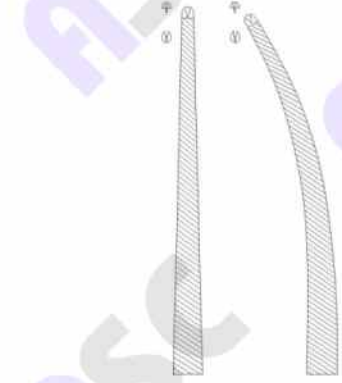

20 cm / 8" 13-3214-20 13-3215-20
26 cm / 10 1/4" 13-3214-26 13-3215-26
Straight Curved
1:2 Teeth 1:2 Teeth

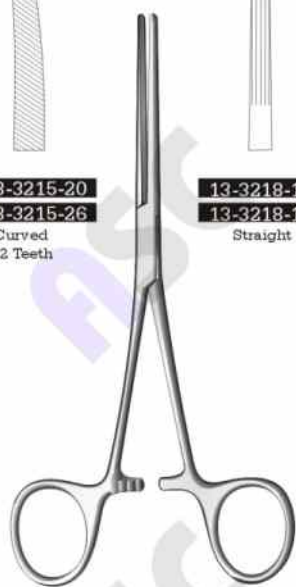

Bainbridge

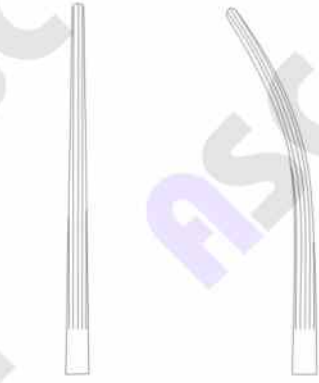

13-3218-15 15 cm / 6" 13-3219-15
13-3218-18 18.5 cm / 7 1/4" 13-3219-18
Straight Curved

Tissue and Organ Grasping Forceps
Gewebe- und Organfazzangen
Pinzas para tejidos y para sacar 6rganos

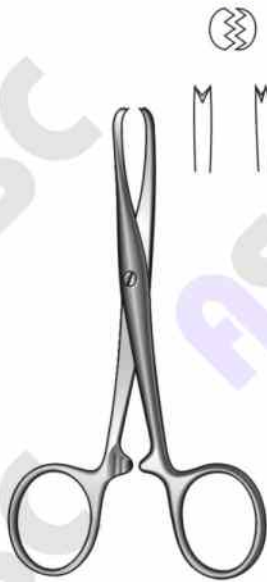

Chaput
13-3220-13 13 cm / 5"
13-3220-16 16 cm / 6¼"

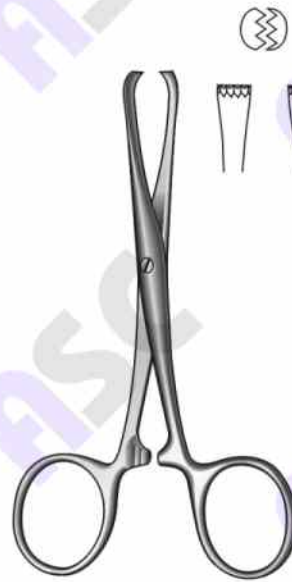

Tuffier
13-3225-13 13 cm / 5"

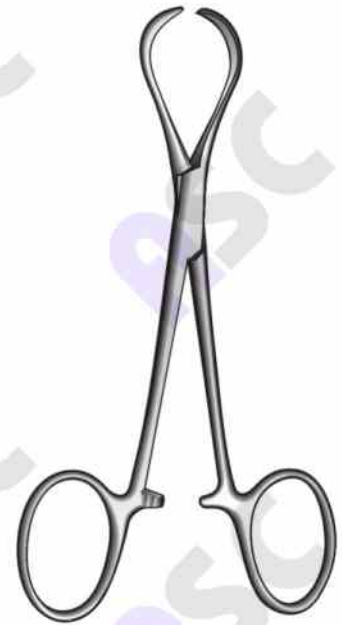

Porrier
13-3230-12 12.5 cm / 5"
13-3230-18 18 cm / 7"



Collin
13-3235-14 14 cm / 5½"

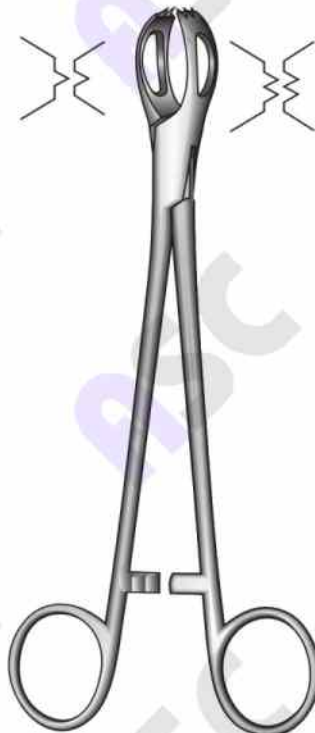

Lane
13-3240-12 12.5 cm / 5"
13-3240-15 15 cm / 6"
13-3240-19 19 cm / 7½"
1.2 Teeth 2.3 Teeth



Pennington

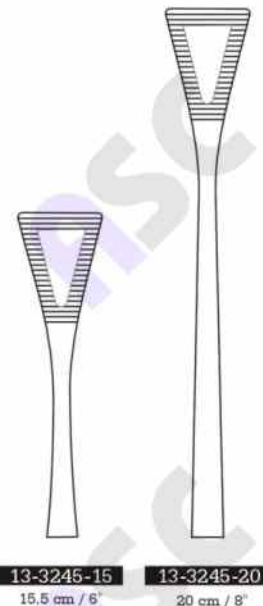

13-3245-15 15.5 cm / 6"
13-3245-20 20 cm / 8"

Tissue and Organ Grasping Forceps
Gewebe- und Organfazzangen
Pinzas para tejidos y para sacar 6rganos



13-3250-12



13-3251-12



Pean
12 cm / 4 3/4"



13-3256-16



13-3257-16



13-3258-16



Collin
13-3255-16
16 cm / 6 1/4"



Hopfner
13-3260-16
16 cm / 6 1/4"
Vessel clamps



Coeur



13-3265-16
16 cm / 6 1/4"



13-3266-18 18 cm / 7"
13-3266-20 20 cm / 8"
13-3266-22 22 cm / 9"



Gregoire



13-3270-16 16 cm / 6 1/4"
13-3270-18 18 cm / 7"
13-3270-20 20 cm / 8"
13-3270-22 22 cm / 9"

Tissue and Organ Grasping Forceps, Angiotribses
Gewebe- und Organfasszangen, Druckklemmen
Pinzas para tejidos y para sacar órganos, Pinzas clamps de presión progresiva



Pratt
13-3275-15
15 cm / 6"

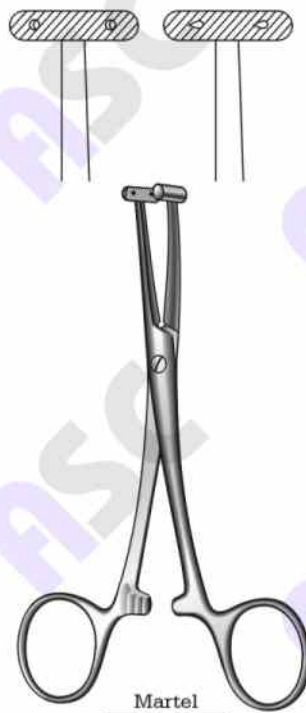

Martel
13-3280-14
14 cm / 5½"
Face lift forceps

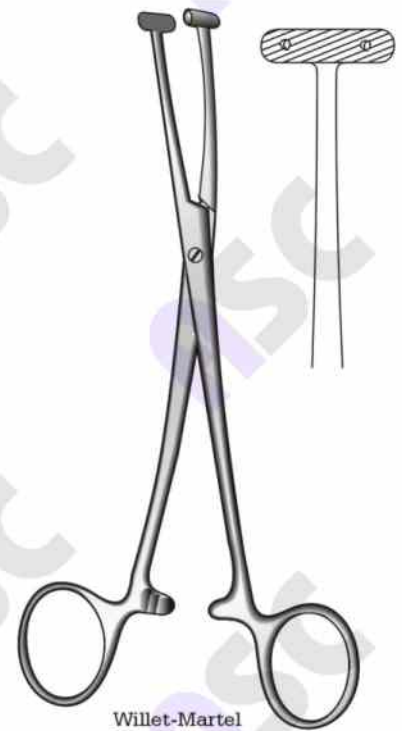

Willet-Martel
13-3285-19
19 cm / 7½"



Buie
13-3290-21
21 cm / 8¼"



Ferguson

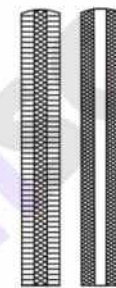

13-3295-17
17 cm / 6¾"

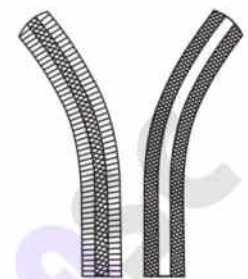

13-3296-17
17 cm / 6¾"

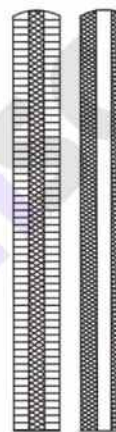

13-3295-20
20 cm / 8"

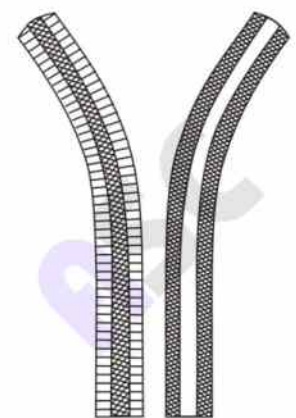

13-3296-20
20 cm / 8"

Artery Forceps, Dissecting and Ligature Forceps
Arterienklemmen, Präparierklemmen
Pinzas hemostáticas, Pinzas para preparaciones y ligaduras



Overholt
Fine pattern

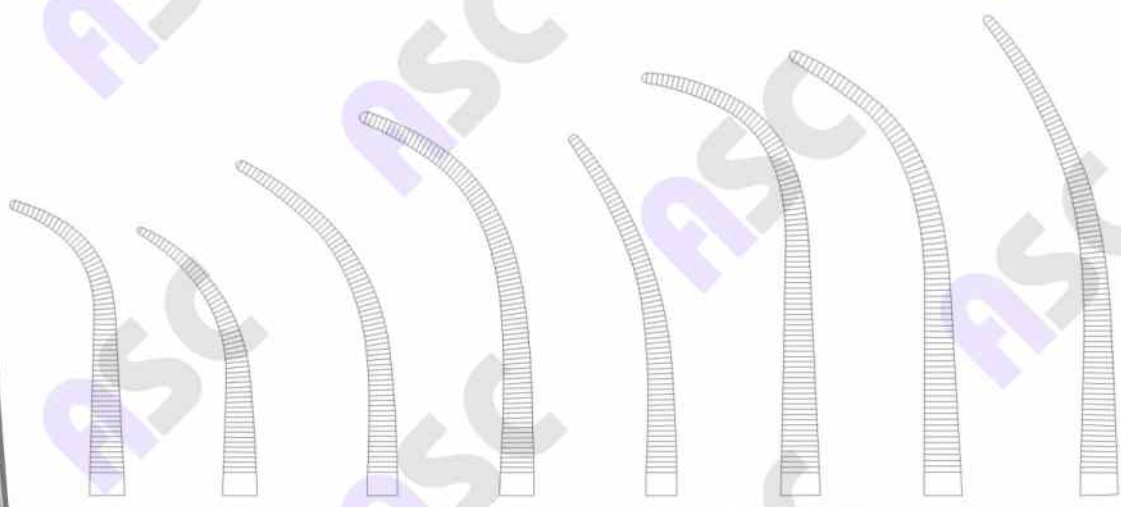

- | | | | | | | | |
|------------------------------------|----------------------------------|----------------------------------|-----------------------------------|-----------------------------------|-------------------------------------|-------------------------------------|----------------------------------|
| 13-3300-21
21.5 cm / 8½" | 13-3301-21
21 cm / 8¼" | 13-3302-22
22 cm / 8¾" | 13-3303-22
22.5 cm / 9" | 13-3304-22
22.5 cm / 9" | 13-3305-29
29.5 cm / 11¾" | 13-3306-29
29.5 cm / 11¾" | 13-3307-30
30 cm / 12" |
|------------------------------------|----------------------------------|----------------------------------|-----------------------------------|-----------------------------------|-------------------------------------|-------------------------------------|----------------------------------|

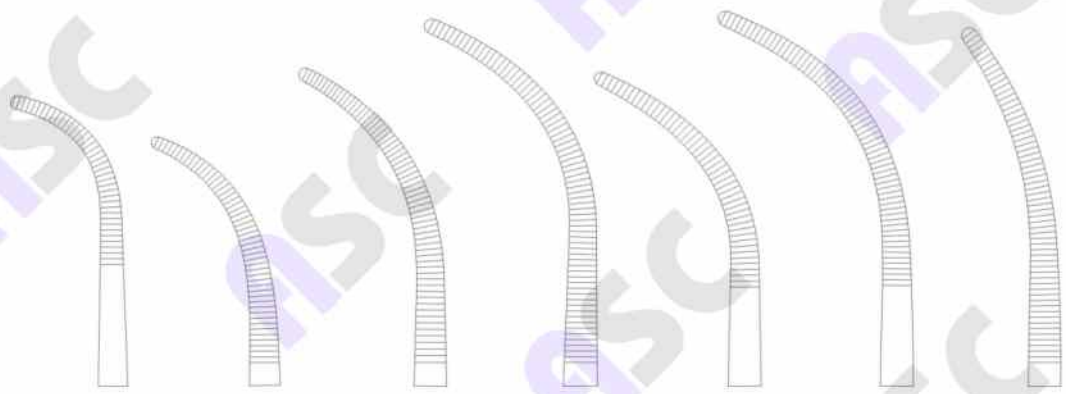

- | | | | | | | |
|-----------------------------------|-----------------------------------|-----------------------------------|-----------------------------------|-----------------------------------|-----------------------------------|-----------------------------------|
| 13-3310-21
21 cm / 8¼" | 13-3311-21
21 cm / 8¼" | 13-3312-21
21 cm / 8¼" | 13-3313-21
21 cm / 8¼" | 13-3314-21
21 cm / 8¼" | 13-3315-21
21 cm / 8¼" | 13-3316-21
21 cm / 8¼" |
| 13-3310-27
27 cm / 10½" | 13-3311-27
27 cm / 10½" | 13-3312-27
27 cm / 10½" | 13-3313-27
27 cm / 10½" | 13-3314-27
27 cm / 10½" | 13-3315-27
27 cm / 10½" | 13-3316-27
27 cm / 10½" |



Overholt-Geissendoerfer

Dissecting and Ligature Forceps
Präparierklemmen
Pinzas para preparación y ligadura

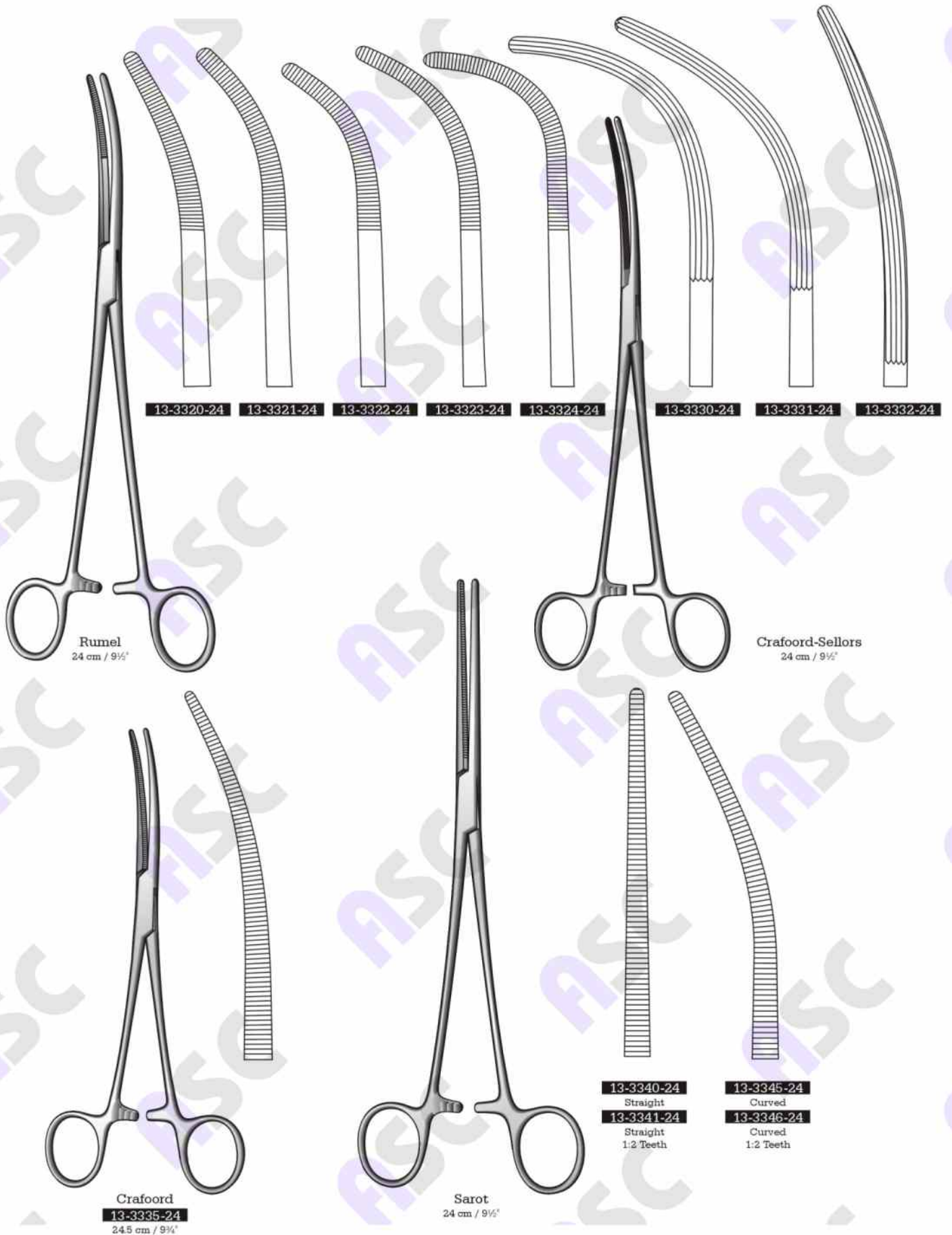

Dissecting and Ligature Forceps
Präparierklemmen
Pinzas para preparación y ligadura



Roberts
13-3350-23 Straight
13-3351-23 Curved
23 cm / 9"

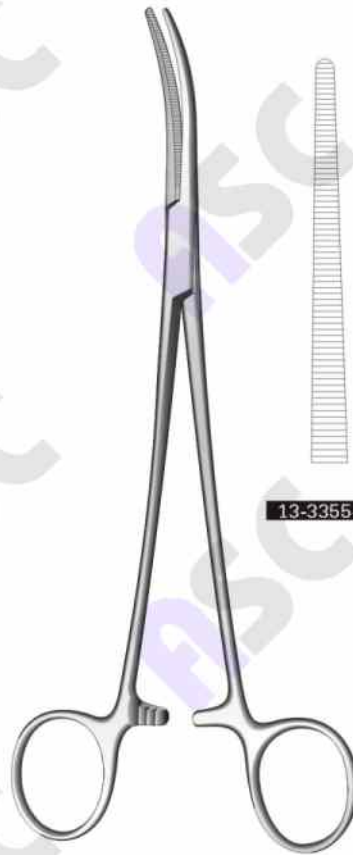

Roberts
22 cm / 8 3/4"

13-3355-22

13-3356-22



Gemini



13-3360-13
13 cm / 5"

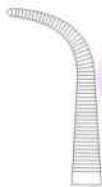

13-3361-16
16 cm / 6 1/4"



13-3362-18
18 cm / 7"



13-3363-20
20 cm / 8"



13-3364-23
23 cm / 9"



13-3365-25
25 cm / 10"



13-3366-28
28 cm / 11"

Dissecting and Ligature Forceps
Präparierklemmen
Pinzas para preparación y ligadura



Johns Hopkins
13-3370-20
20 cm / 8



Lawrence
13-3375-27
27 cm / 10 3/4

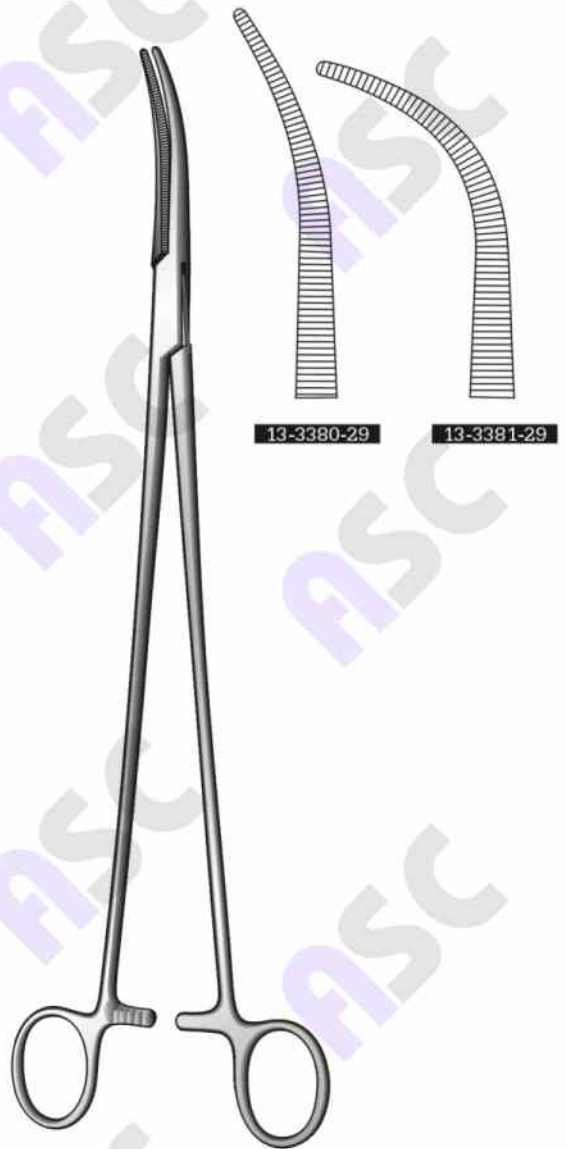

Zenker
29.5 cm / 11 1/2

Dissecting and Ligature Forceps
Präparierklemmen
Pinzas para preparación y ligadura



Toennis

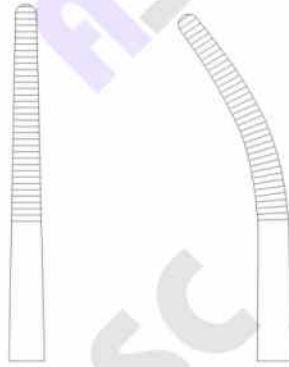

13-3385-21 21 cm / 8¼"
13-3385-26 26 cm / 10¼"

13-3386-21
13-3386-26

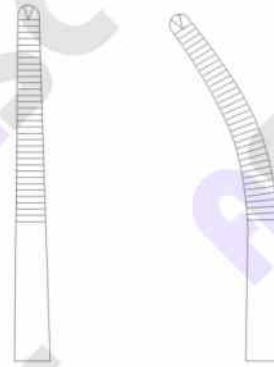

13-3387-21 21 cm / 8¼"
13-3387-26 26 cm / 10¼"

13-3388-21
13-3388-26

1:2 Teeth

1:2 Teeth



Baby-Mixer
14 cm / 5½"



13-3390-14



13-3391-14



Mixer
14 cm / 5½"



13-3395-14



Mixer-Baby
18 cm / 7"



13-0520-18

Dissecting and Ligature Forceps
Präparierklemmen
Pinzas para preparación y ligadura

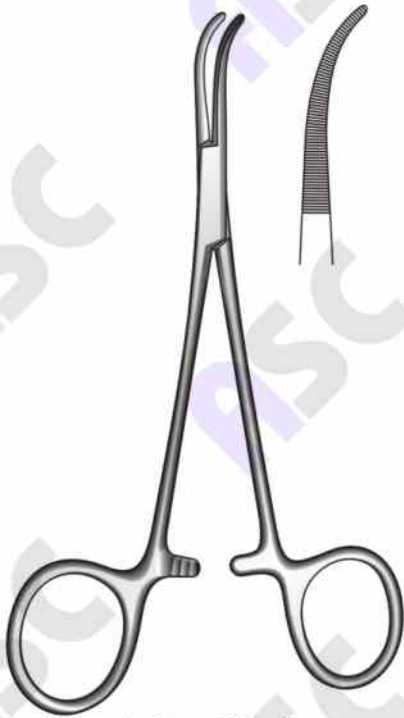

Jacobson Mixer Forceps
13-3400-15
15.5 cm / 6"
Extra delicate



13-3405-15
15.5 cm / 6"

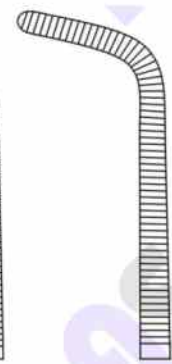

13-3405-18
18 cm / 7"

Mixer



Mixer
13-3410-22
22 cm / 8 3/4"



Mixer
13-3415-23
23 cm / 9"

Dissecting and Ligature Forceps, Bile Duct Clamps
Präparierklemmen, Gallenkanalklemmen
Pinzas para preparación y ligadura, Pinzas para conducto biliar



Mixer-O,Shaughnessy
13-3420-18
18 cm / 7"



Mixer



13-3425-22
22 cm / 8 3/4"

13-3425-25
25 cm / 10"

13-3425-28
28 cm / 11"



Lower
13-3430-18
18 cm / 7"



Lahey



13-3435-19
19 cm / 7 1/2"

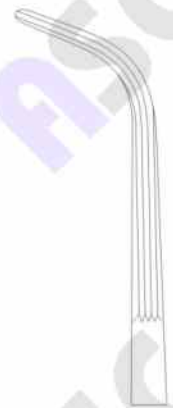

13-3435-23
23 cm / 9"

Dissecting and Ligature Forceps, Haemostatic Forceps
 Präparierklemmen, Arterienklemmen
 Pinzas pra preparación y ligadura, Pinzas hemostáticas

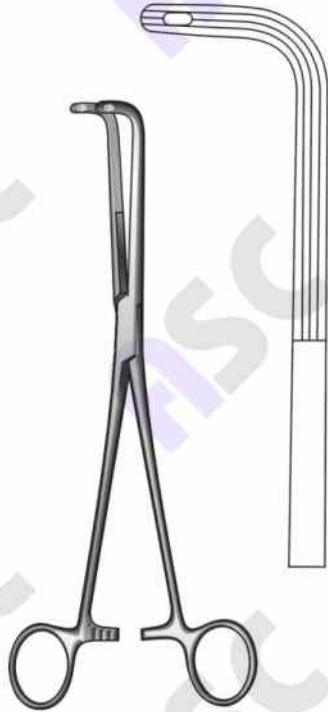

Finocchietto
 13-3440-24
 24 cm / 9½"



13-3445-19 13-3446-19

Schmidt
 19 cm / 7½"



13-3450-19 13-3451-19

Schmidt
 19 cm / 7½"



13-3455-18 13-3456-18

Sawtell
 18.5 cm / 7¼"

Artery Forceps, Kidney Pedicle Clamp Forceps
Arterienklemmen, Nierensteinklemmen
Pinzas hemostáticas, Pinzas clamps para cálculos renales



13-3460-19



13-3461-19



13-3465-20
20 cm / 8"

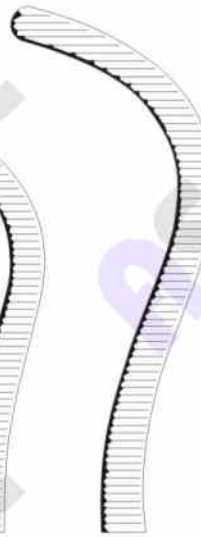

13-3465-22
22 cm / 8 1/2"



13-3465-24
24 cm / 9 1/2"



Negus
19 cm / 7 1/2"



Guyon



Guyon
13-3470-23
23 cm / 9"

Kidney Pedicle Clamp Forceps
Nierensteinklemmen
Pinzas clamps para pedunculos renales

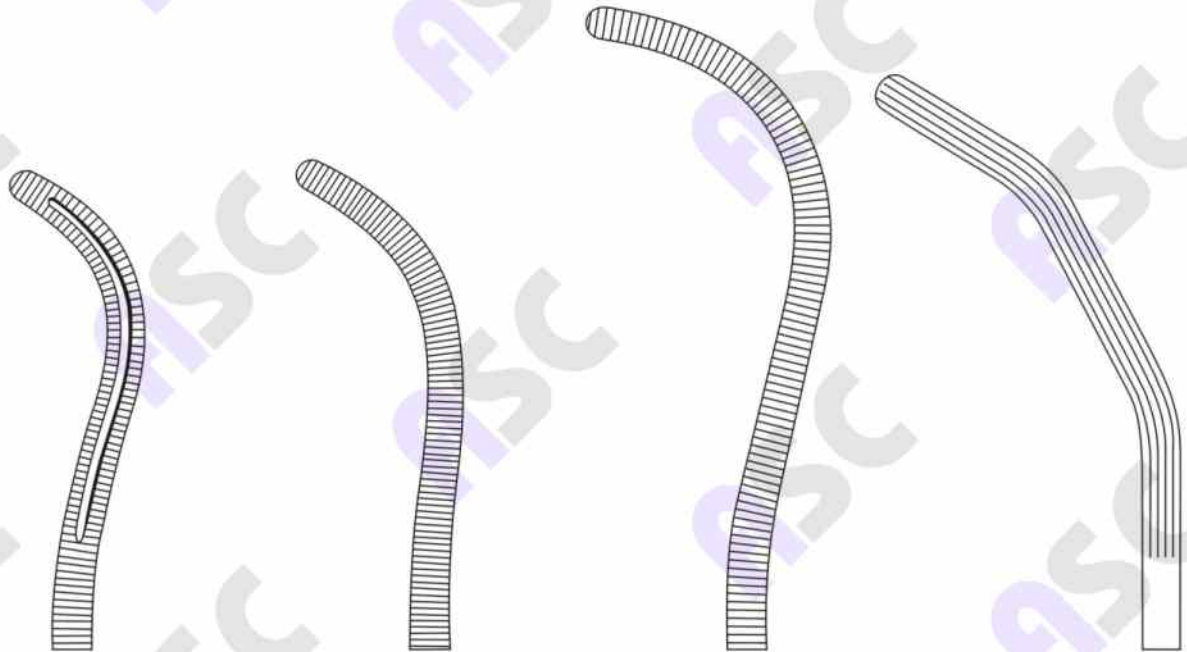

Stille
13-3475-23
23 cm / 9"

Mayo
13-3480-23
23 cm / 9"

Mayo-Guyon
13-3485-23
23 cm / 9"

Herrick
13-3490-23
23 cm / 9"

Gall Duct Clamps
Gallenkanalklemmen
Pinzas para conducto biliar



Crile
13-3495-20
20 cm / 8"



Gray

13-3500-22
22 cm / 8 3/4"

13-3500-23
23 cm / 9"



Gray

13-3505-22
22 cm / 8 3/4"

13-3505-23
23 cm / 9"



Dean-Shallcross
13-3510-18
18 cm / 7"

Gall Duct Clamps, Peritoneal Clamp Forceps
Gallenkanalklemmen, Peritoneumklemmen
Pinzas para conducto biliar, Pinzas clamps para peritoneo



Desjardins
13-3515-21
21 cm / 8 1/4"



Desjardins
13-3520-21
21 cm / 8 1/4"



Baby-Mikulicz
13-3525-14
14 cm / 5 1/2"

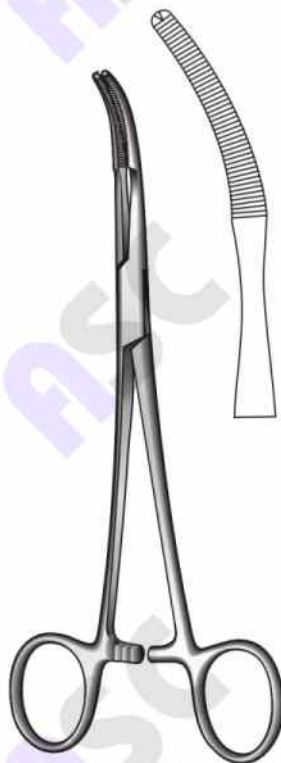

Mikulicz
13-3530-20
20 cm / 8"

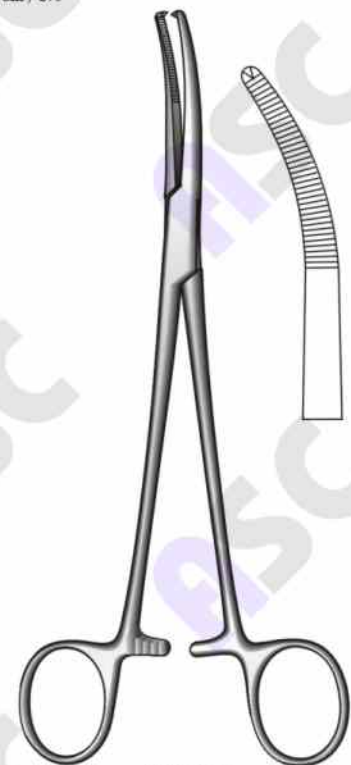

Mikulicz
13-3535-20
20 cm / 8"

Hysterectomy and Vaginal Clamp Forceps
Hysterektomieklappen, Vaginalklappen
Pinzas clamps para histerectomía y vaginales



Phaneuf
21 cm / 8 1/4"
1:2 Teeth

13-3540-21



13-3541-21



Faure
20 cm / 8"
1:2 Teeth

13-3545-20



13-3546-20



Wertheim
1:2 Teeth

13-3550-22
22 cm / 8 1/4"
Slightly curved



13-3550-23
23 cm / 9"
More curved



Wertheim
1:2 Teeth

13-3555-22
22 cm / 8 1/4"
Slightly curved



13-3555-23
23 cm / 9"
More curved

Hysterectomy and Vaginal Clamp Forceps
Hysterektomieklappen, Vaginalklappen
Pinzas clamps para histerectomía y vaginales



Wertheim
13-3560-24
24 cm / 9½"
Extra strong



Wertheim
13-3565-25
25 cm / 10"



Wertheim Cullen
13-3570-21
21.5 cm / 8½"



Moynihan

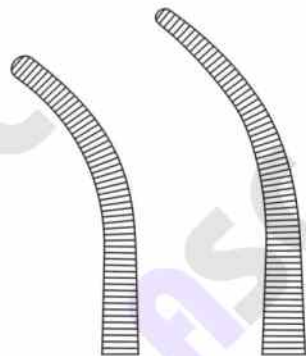

13-3575-23
23 cm / 9"

13-3575-24
24 cm / 9½"



Maingot

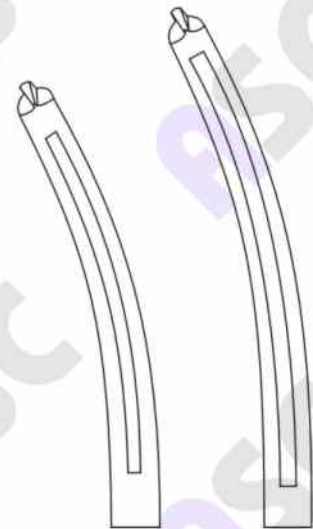

13-3580-20
20.5 cm / 8"

13-3580-25
25 cm / 10"

Hysterectomy and Vaginal Clamp Forceps
Hysterektomieklappen, Vaginalklappen
Pinzas clamps para histerectomía y vaginales



Heaney

13-3585-19 19 cm / 7½"

13-3585-21 21 cm / 8¼"

13-3585-24 24.5 cm / 9¾"

Hysterectomy forceps
Heavy pattern, single tooth
Curved



Heaney

13-3590-19 19 cm / 7½"

13-3590-21 21 cm / 8¼"

Heavy pattern

13-3590-24 24.5 cm / 9¾"

Extra heavy pattern
Hysterectomy forceps
double tooth, curved



Heaney-Ballentine
21 cm / 8¼"
Longitudinal serrations, single tooth

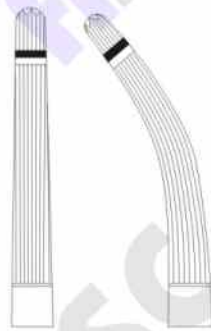

13-3595-21
Straight

13-3596-21
Curved



Ballentine
13-3600-21
Garland
13-3601-21
21 cm / 8¼"
Longitudinal serrations,
single tooth, angled on flat

Hysterectomy and Vaginal Clamp Forceps
Hysterektomieklammen, Vaginalklappen
Pinzas clamps para histerectomía y vaginales

ATRAUMA



Heaney



13-3605-22
22.5 cm / 9"



13-3606-21
21.5 cm / 8½"

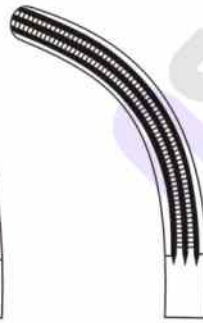

13-3607-22
22 cm / 8½"

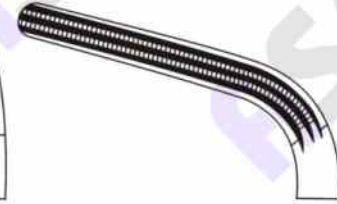

13-3608-20
20.5 cm / 8"



13-3610-25
25 cm / 10"



13-3611-24
24.5 cm / 9¾"



13-3612-24
24 cm / 9½"



13-3613-22
22 cm / 8½"

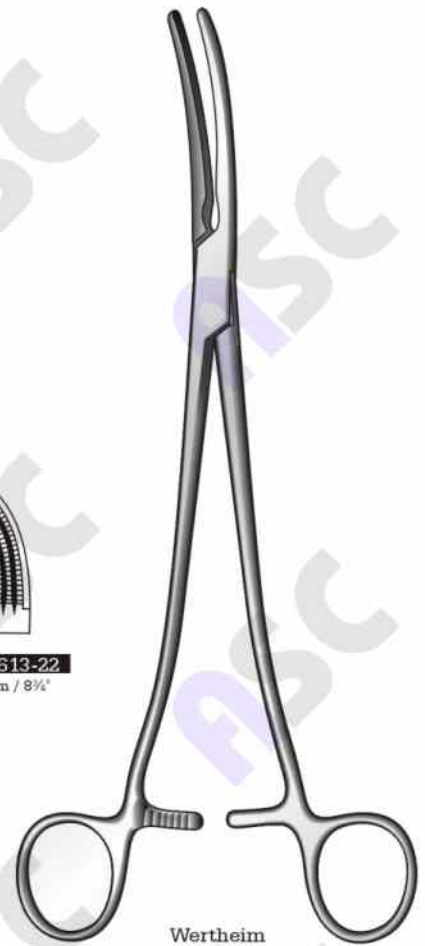

Wertheim
Parametrium clamps

Hysterectomy and Vaginal Clamp Forceps
Hysterektomieklappen, Vaginalklappen
Pinzas clamps para histerectomía y vaginales

ATRAUMA

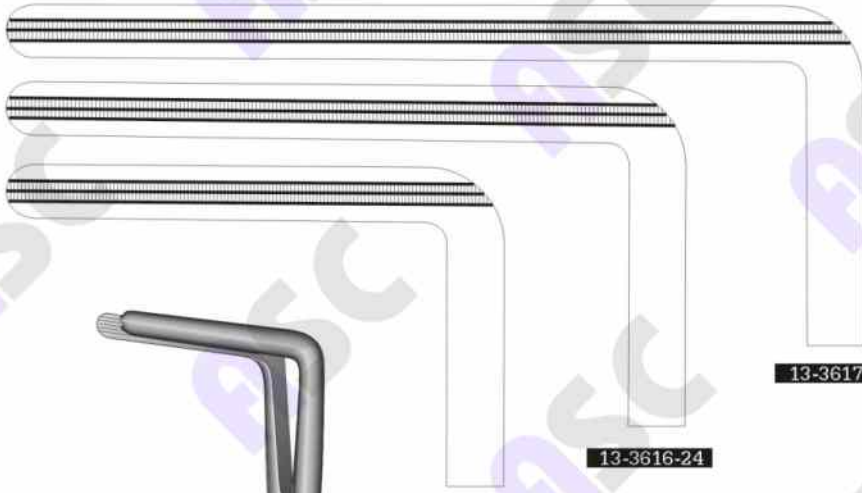

13-3617-24

13-3616-24

13-3615-24

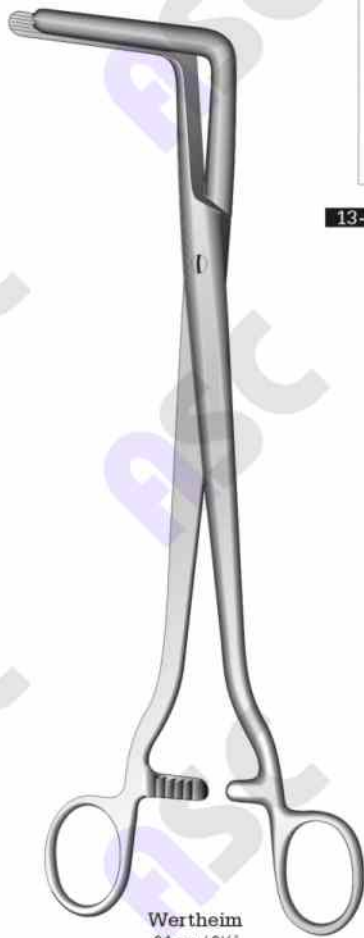

Werheim
24 cm / 9½"

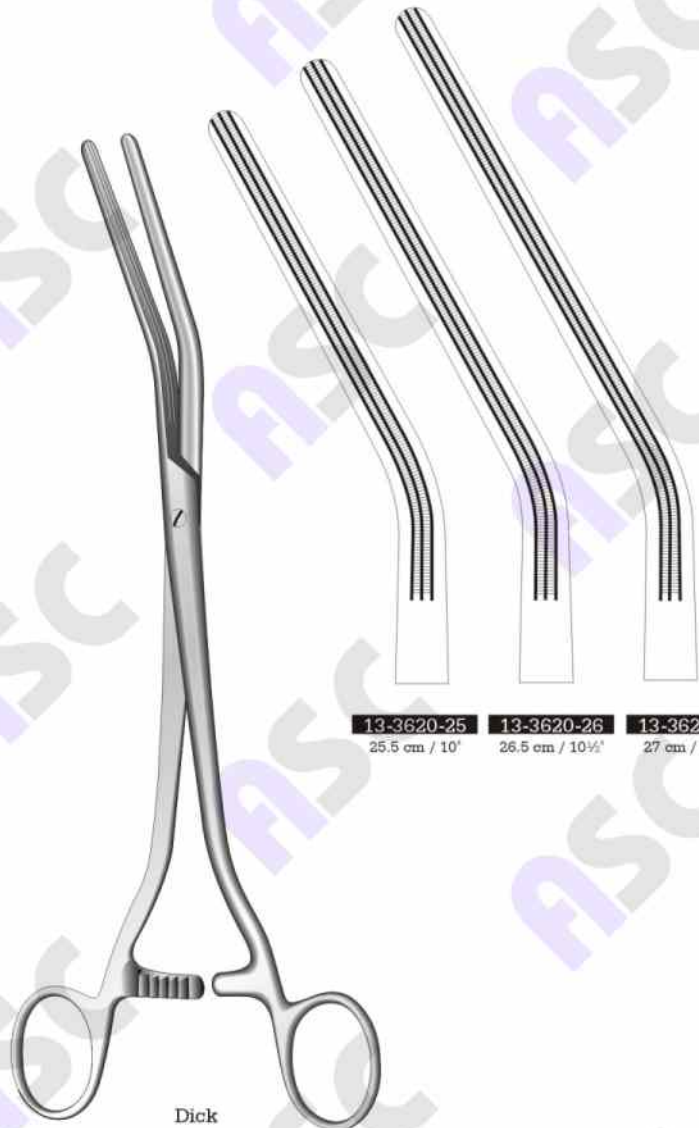

13-3620-25
25.5 cm / 10"

13-3620-26
26.5 cm / 10½"

13-3620-27
27 cm / 10¾"

Dick

Towel Forceps
Tuchklemmen
Pinzas para compresas, Pinzas de campo



Jones
13-0982-05 5 cm / 2"
13-0982-09 9 cm / 3½"



Schaedel
13-0976-09 9 cm / 3½"



English Model
13-3625-09 9 cm / 3½"

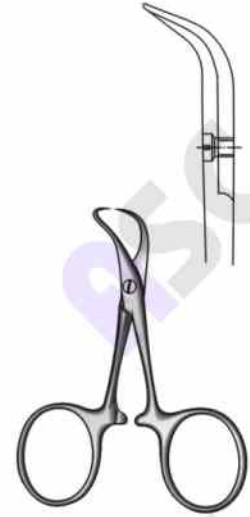

Backhaus
13-1016-09 9 cm / 3½"
13-1016-11 11 cm / 4¼"
13-1016-13 13 cm / 5"
13-1016-15 15 cm / 6"



Roeder
13-3630-11 11 cm / 4¼"
13-3630-13 13 cm / 5"
13-3630-15 15 cm / 6"

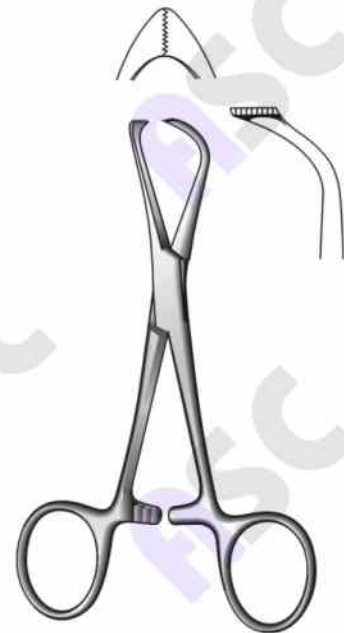

Loma
13-1020-10 10 cm / 4"
13-1020-13 13 cm / 5"

Towel Forceps
Tuchklemmen
Pinzas para compresas, Pinzas de campo

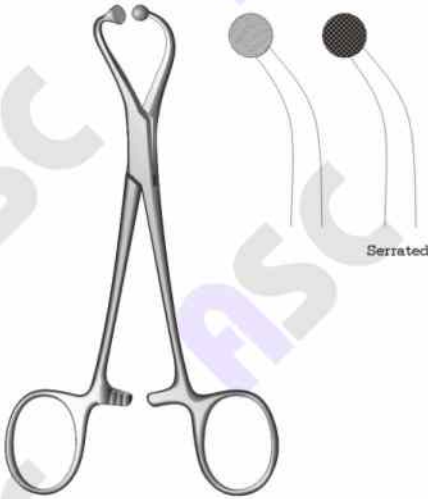

Ball-Socket
13-3635-11 11 cm / 4½"
13-3635-14 14 cm / 5½"
 For paper cloths
13-3636-11 11 cm / 4½"
13-3636-14 14 cm / 5½"
 Serrated



Tohoku
13-1024-10 10 cm / 4"
13-1024-13 13 cm / 5¼"

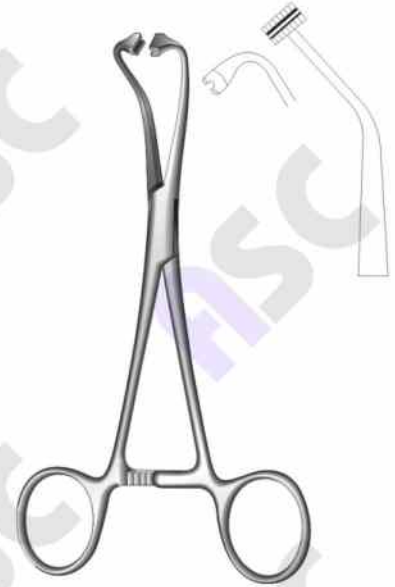

Peer's-Bertram
13-3640-15
 15 cm / 6"
 For paper cloths



Bernhard
13-3645-16
 16.5 cm / 6½"

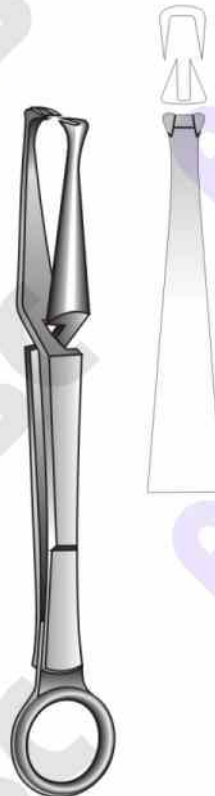

Doyen
13-3650-18
 18 cm / 7"



Jayle
13-3655-13
 13 cm / 5"

Tubing Clamps
Schlauchklemmen
Pinzas para tubos

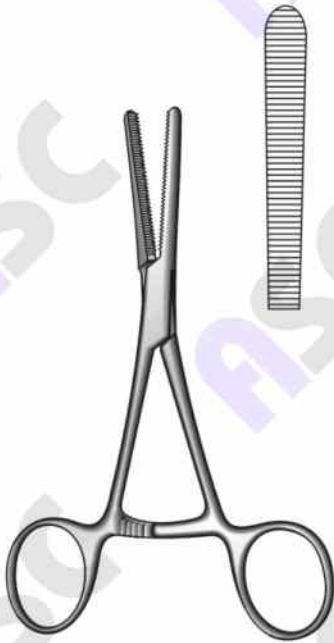

13-3660-14
14.5 cm / 5 7/8"
With extra long ratchet



13-3665-14 14.5 cm / 5 7/8"
13-3665-16 16 cm / 6 1/4"
13-3665-18 18 cm / 7"



13-3670-16
With stainless steel rollers
13-3671-16
With teflon rollers
16 cm / 6 1/4"

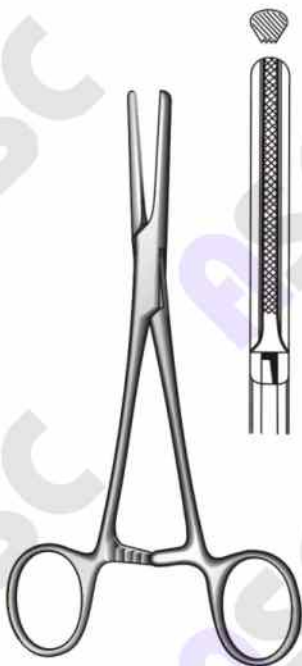

Standard
13-3675-14 14 cm / 5 1/2"
13-3675-15 15 cm / 6"
13-3675-18 18 cm / 7"
13-3675-20 20 cm / 8"

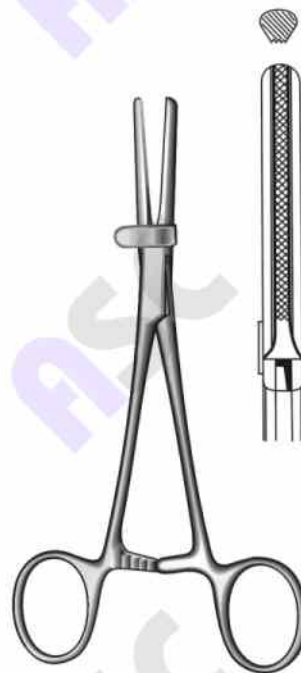

13-3680-14 14 cm / 5 1/2"
13-3680-15 15 cm / 6"
13-3680-18 18 cm / 7"
13-3680-20 20 cm / 8"
With guard

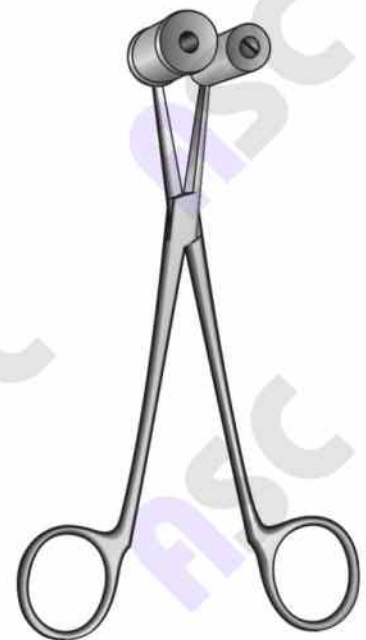

Gunnar
13-3685-18
With stainless steel rollers
13-3686-18
With teflon rollers
18.5 cm / 7 1/4"

Dressing, Cotton Swab Holding Forceps
Korn- und Tupferzangen
Pinzas para vendajes, Tapones

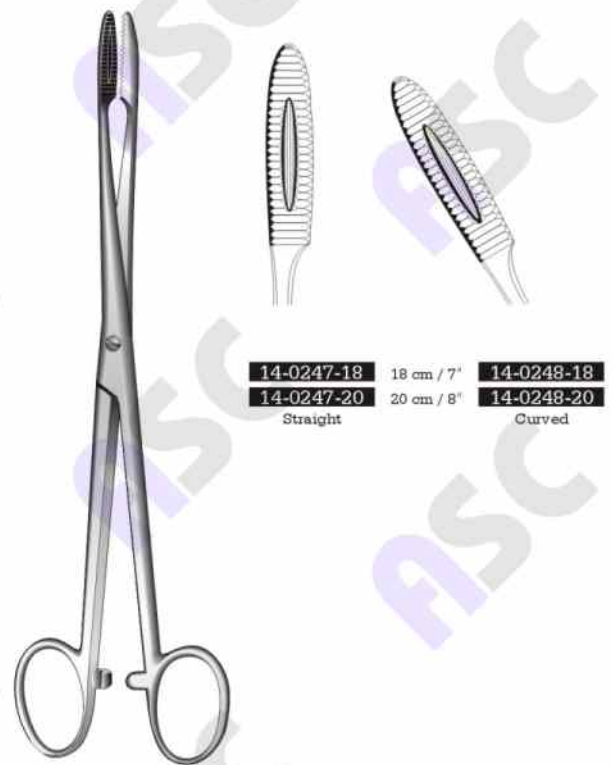
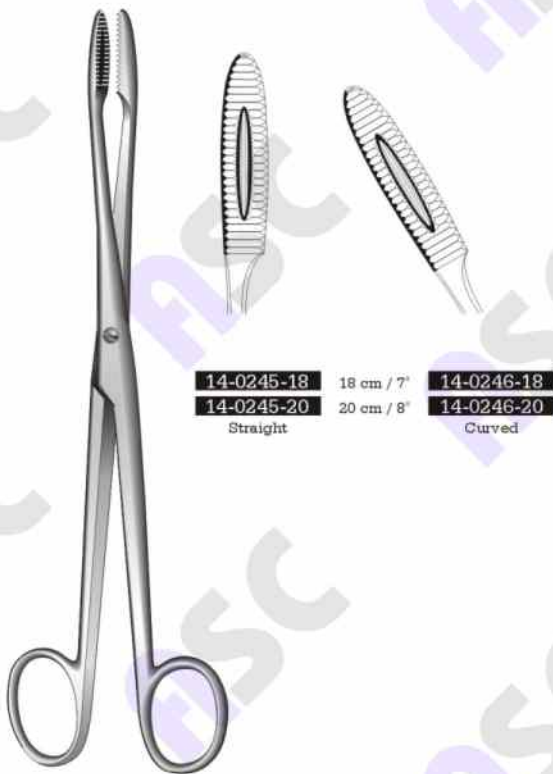
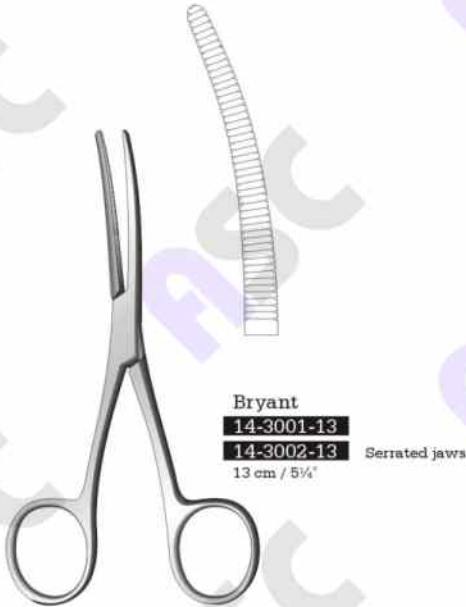

Gross-Maier

Gross-Maier

Polypus, Dressing and Cotton Swab Forceps
Korn- (Polypen-)zangen, Tupferzangen
Pinzas para pólipos y vendajes, Pinzas para tapones

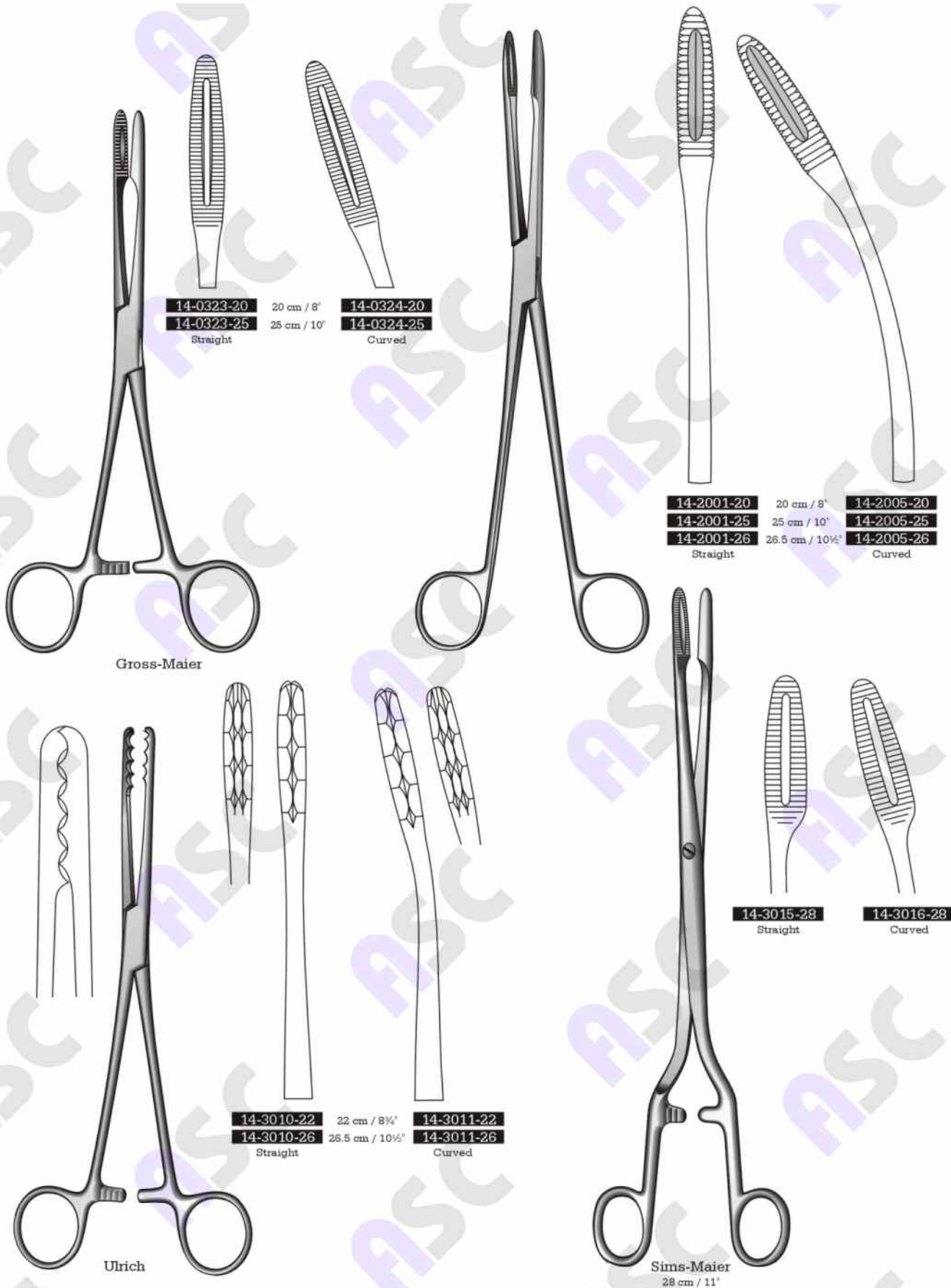

Polypus, Dressing, Cotton Swab & Foreign Body Forceps
Korn- (Polypen-)zangen, Tupfer- und Fremdkörperzangen
Polopos, vendajes, Tapones, Pinzas para cuerpos extraños



14-3020-26
Straight

14-3021-26
Curved



Pelkmann
26 cm / 10 1/4"



Maier
14-3025-25
25 cm / 10"



Collin
14-3030-25
25 cm / 10"

Dressing Forceps, Sponge Forceps
Kornzangen, Schwammzangen
Pinzas para vendajes, Pinzas para tapones



Cheron
14-3035-25
25 cm / 10"



Cheron
14-3045-24
24 cm / 9½"
Handles laterally angled

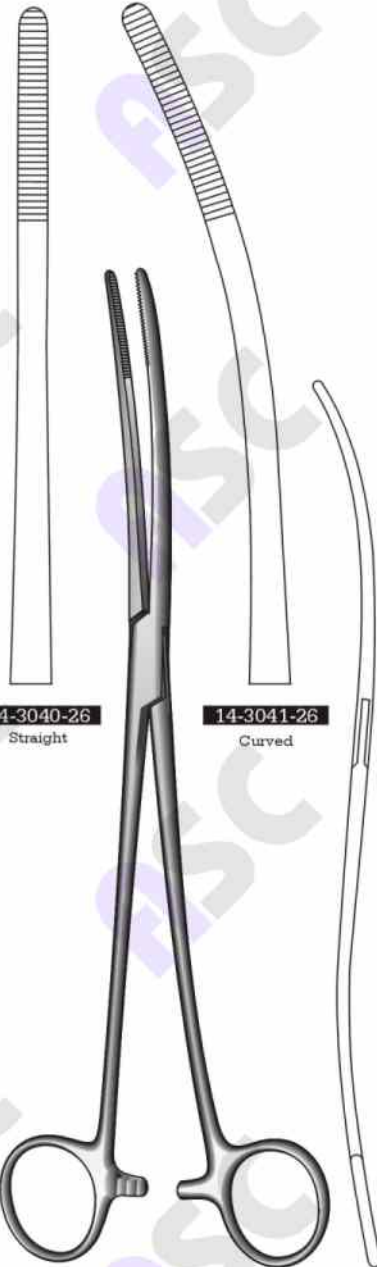

14-3040-26
Straight

14-3041-26
Curved

Bozemmann
26 cm / 10¼"

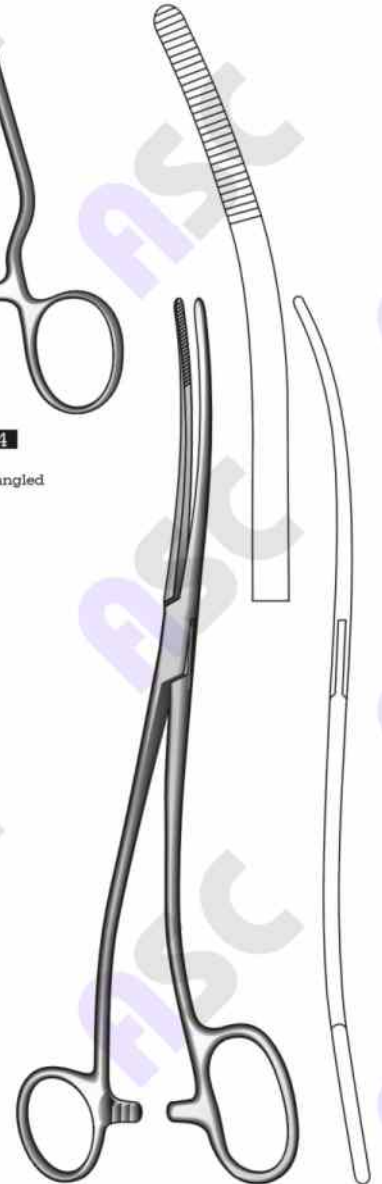

Bozemmann-Douglas
14-3050-26
26 cm / 10¼"
One ring large

Sponge Forceps
Schwammzangen
Pinzas para tapones



Foyerster

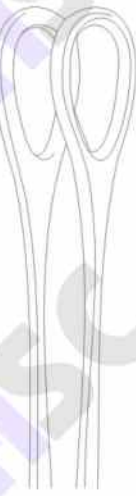

14-3055-25
25 cm / 10"
Smooth jaws



14-3056-18 18 cm / 7"
14-3056-20 20 cm / 8"
14-3056-25 25 cm / 10"



14-3057-25
25 cm / 10"
Smooth jaws



14-3058-18 18 cm / 7"
14-3058-20 20 cm / 8"
14-3058-24 25 cm / 10"



Rampley

14-3060-18 18 cm / 7"
14-3060-25 25 cm / 10"



Rampley



14-3065-18 18 cm / 7"
14-3065-24 25 cm / 10"
Box lock

14-3066-18 18 cm / 7"
14-3066-24 25 cm / 10"
Screw lock

Tissue and Organ Holding Forceps
Gewebe- und Organfazzangen
Pinzas para tejidos y 6rganos



Lockwood
30-3001-20
20 cm / 8"

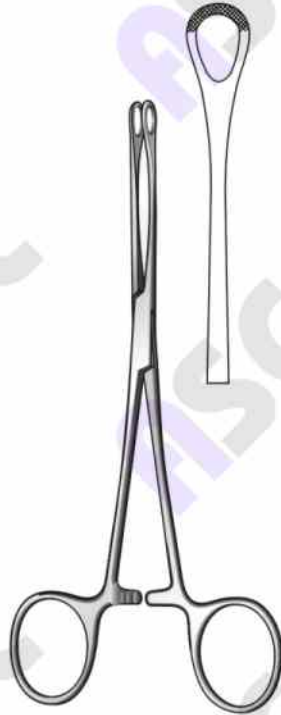

Williams
30-3005-16
16 cm / 6 1/4"

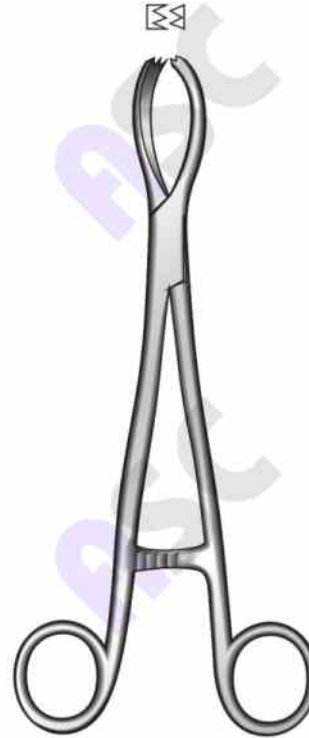

Littlewood
30-3010-19
19 cm / 7 1/2"



Denis-Browne
30-3015-18
18 cm / 7"



Young
30-3020-21
21 cm / 8 1/4"



Child
30-3025-24
24 cm / 9 1/2"



Babcock
Straight

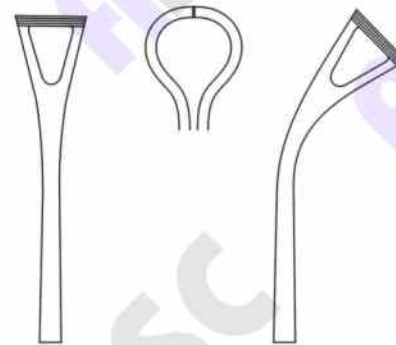

30-3030-14	14 cm / 5 1/2"	30-3035-14
30-3030-16	16 cm / 6 1/4"	30-3035-16
30-3030-18	18 cm / 7"	30-3035-18
30-3030-20	20 cm / 8"	30-3035-20
30-3030-24	24 cm / 9 1/2"	30-3035-24
30-3030-30	30 cm / 12"	30-3035-30
Straight		Angled 45°

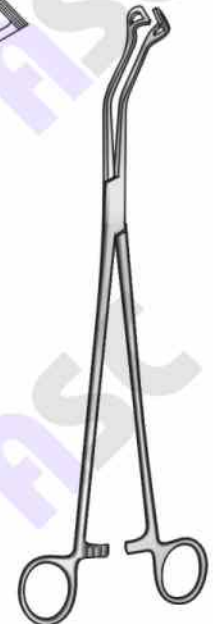

Babcock
Angled 45°