

Tissue and Organ Holding Forceps  
Gewebe- und Organfanzangen  
Pinzas para tejidos y órganos

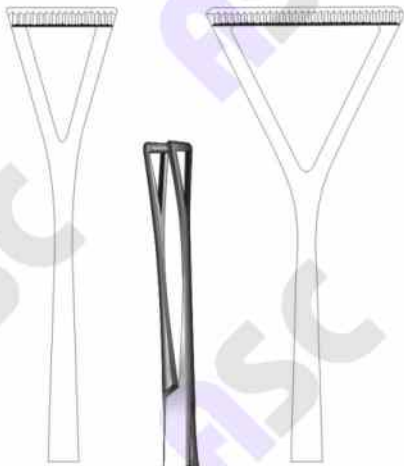

13 mm jaws  
**30-3040-18**  
18 cm / 7"  
**30-3040-20**  
20 cm / 8"

25 mm jaws  
**30-3041-20**  
20 cm / 8"  
**30-3041-23**  
23 cm / 9"



Duval

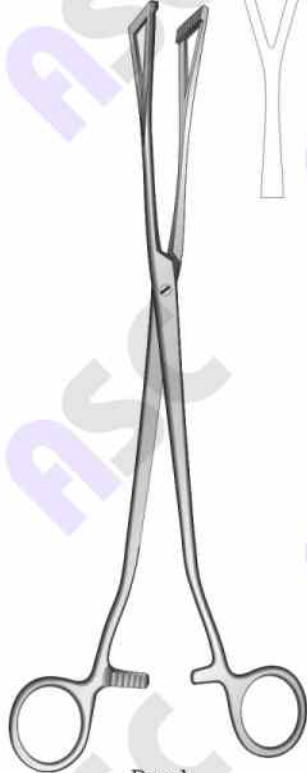

Duval  
**30-3045-28**  
28 cm / 11"  
25 mm wide jaws



Allis-Atrauma



**30-3050-16**  
16 cm / 6 1/4"

**30-3050-20**  
20 cm / 8"



**30-3050-25**  
25 cm / 10"

**30-3050-30**  
30 cm / 12"



Babcock-Atrauma



**30-3055-16**  
16 cm / 6 1/4"



**30-3055-20**  
20 cm / 8"



Scheibe



**30-3060-18**  
18 cm / 7"  
Narrow

**30-3060-20**  
20 cm / 8"  
Medium



**30-3060-23**  
23 cm / 9"  
Wide

Tissue and Organ Holding Forceps  
 Gewebe- und Organfazzangen  
 Pinzas para tejidos y 6rganos

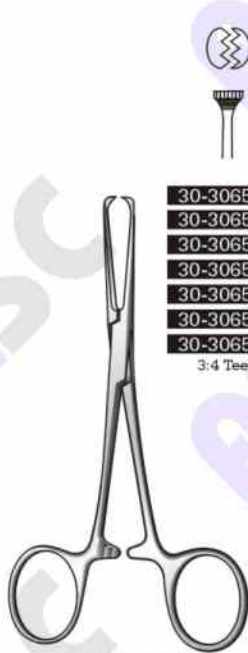

- 30-3065-13** 13 cm / 5"
  - 30-3065-15** 15 cm / 6"
  - 30-3065-18** 18 cm / 7"
  - 30-3065-20** 20 cm / 8"
  - 30-3065-23** 23 cm / 9"
  - 30-3065-25** 25 cm / 10"
  - 30-3065-30** 30 cm / 12"
- 3:4 Teeth

Allis-Baby

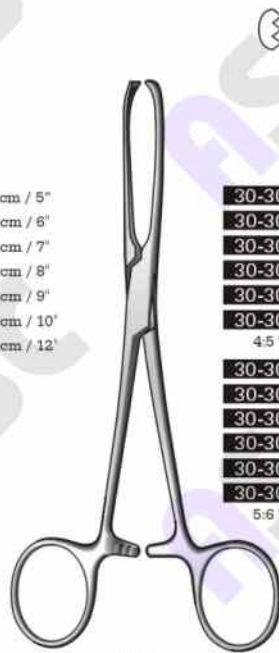

- 30-3070-15** 15 cm / 6"
  - 30-3070-18** 18 cm / 7"
  - 30-3070-20** 20 cm / 8"
  - 30-3070-23** 23 cm / 9"
  - 30-3070-25** 25 cm / 10"
  - 30-3070-30** 30 cm / 12"
- 4:5 Teeth
- 30-3071-15** 15 cm / 6"
  - 30-3071-18** 18 cm / 7"
  - 30-3071-19** 19 cm / 7½"
  - 30-3071-23** 23 cm / 9"
  - 30-3071-25** 25 cm / 10"
  - 30-3071-30** 30 cm / 12"
- 5:6 Teeth

Allis

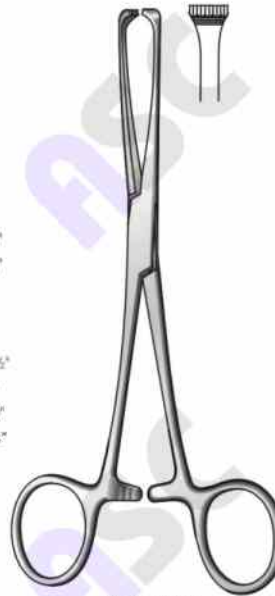

Boys-Allis  
**30-3075-15**  
 15 cm / 6"  
 7:8 Teeth



Allis-Adair  
**30-3080-15**  
 15 cm / 6"  
 10:11 Teeth



Judd-Allis  
**30-3085-15** 15 cm / 6"  
**30-3085-19** 19 cm / 7½"



Lockwood-Allis  
**30-3090-16** 16 cm / 6¼"  
**30-3090-20** 20 cm / 8"



Allis  
**30-3095-20**  
 20 cm / 8"  
 5:6 Teeth

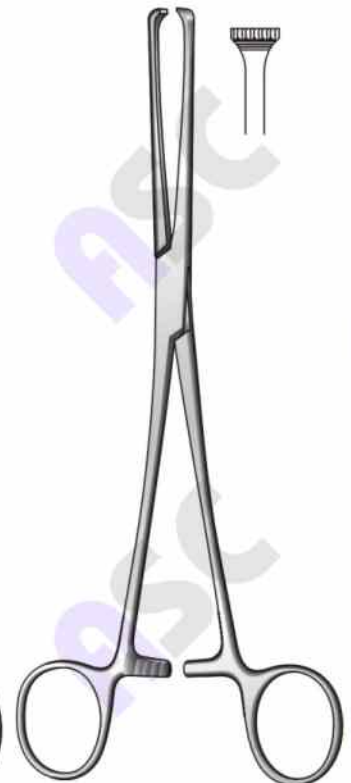

Thoms-Allis  
**30-3101-20**  
 20 cm / 8"  
 6:7 Teeth

Tissue and Organ Holding Forceps, Intestinal Clamp Forceps  
Gewebe- und Organfazzangen, Darmklemmen  
Pinzas para tejidos y 6rganos, Pinzas clamps intestinales



Allis

- 30-3105-15T 15 cm / 6"
- 30-3105-19T 19 cm / 7½"
- 30-3105-23T 23 cm / 9"
- 30-3105-25T 25 cm / 10"
- 30-3105-30T 30 cm / 12"



Babcock

- 30-3110-16T 16 cm / 6¼"
- 30-3110-18T 18 cm / 8"
- 30-3110-20T 20 cm / 7"
- 30-3110-24T 24 cm / 9½"
- 30-3110-30T 30 cm / 12"

Straight  
Normal profile

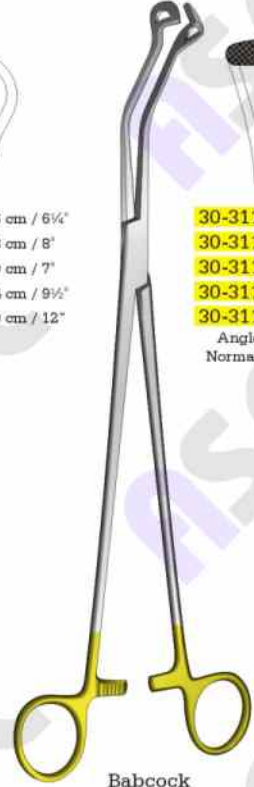

Babcock

- 30-3115-16T 16 cm / 6¼"
- 30-3115-18T 18 cm / 8"
- 30-3115-20T 20 cm / 8"
- 30-3115-24T 24 cm / 9½"
- 30-3115-30T 30 cm / 12"

Angled 45°  
Normal profile

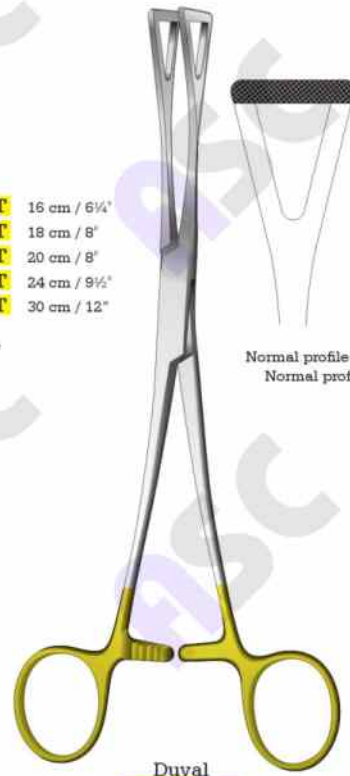

Duval  
30-3120-20T  
20 cm / 8"

Normal profile  
Normal profile



Dannes  
30-3125-23  
23 cm / 9"



Allen  
30-3130-20 20.5 cm / 8¼"  
30-3130-24 24 cm / 9½"



Baby-Allen  
30-3135-16  
16.5 cm / 6½"

Intestinal Clamp Forceps  
Darmklemmen  
Pinzas clamps intestinales



30-3140-17

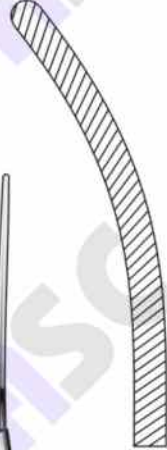

30-3141-17

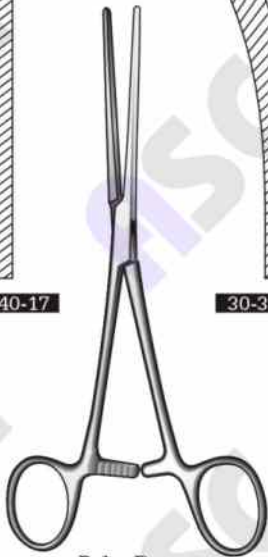

Baby-Doyen  
17 cm / 6 3/4"



30-3145-21  
30-3145-23



Doyen  
21 cm / 8 1/4"  
23 cm / 9"  
30-3146-21  
30-3146-23



30-3150-17  
30-3150-21  
30-3150-24

17 cm / 6 3/4"  
21 cm / 8 1/4"  
24 cm / 9 1/2"

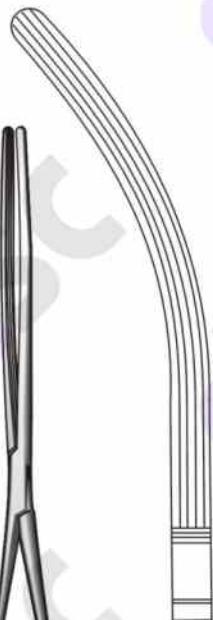

30-3151-17  
30-3151-21  
30-3151-24

17 cm / 6 3/4"  
21 cm / 8 1/4"  
24 cm / 9 1/2"



Mayo-Robson



30-3155-25

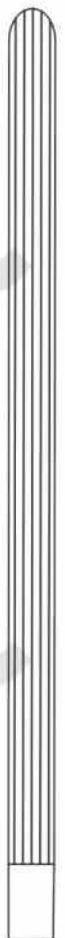

30-3156-25

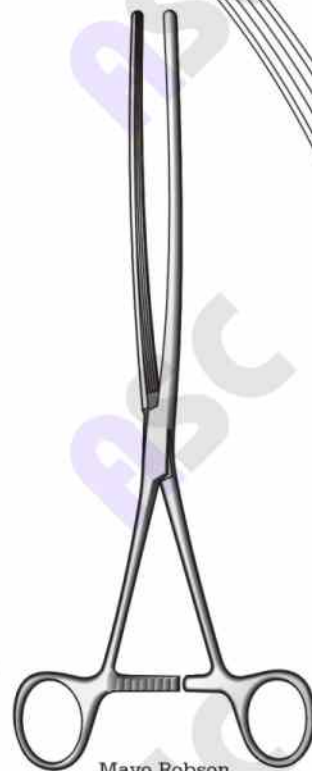

Mayo Robson  
25 cm / 10"

Atrauma Intestinal and Stomach Clamp Forceps with Serrations  
Atrauma Darm- und Magenklammern mit Zahnung  
Atrauma pinzas clamps intestinales con dentado



Kocher  
Very elastic

- |            |                |            |
|------------|----------------|------------|
| 30-3160-22 | 22 cm / 8 3/4" | 30-3161-22 |
| 30-3160-25 | 25 cm / 10"    | 30-3161-25 |
| 30-3160-28 | 28 cm / 11"    | 30-3161-28 |



Doyen-Atrauma

- |            |                |            |
|------------|----------------|------------|
| 30-3165-13 | 13 cm / 5"     | 30-3166-13 |
| 30-3165-16 | 16 cm / 6 1/4" | 30-3166-16 |
| 30-3165-18 | 18 cm / 7"     | 30-3166-18 |
| 30-3165-21 | 21 cm / 8 1/4" | 30-3166-21 |
| 30-3165-23 | 23 cm / 9"     | 30-3166-23 |



Kocher-Atrauma

- |            |                |            |
|------------|----------------|------------|
| 30-3170-22 | 22 cm / 8 3/4" | 30-3171-22 |
| 30-3170-25 | 25 cm / 10"    | 30-3171-25 |
| 30-3170-28 | 28 cm / 11"    | 30-3171-28 |

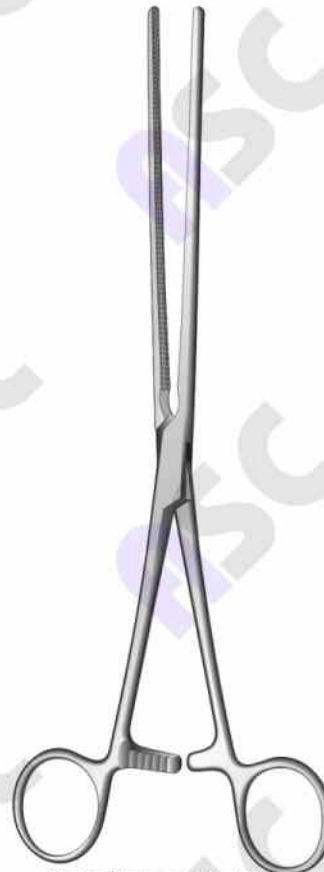

Mayo-Robson-Atrauma  
25 cm / 10"

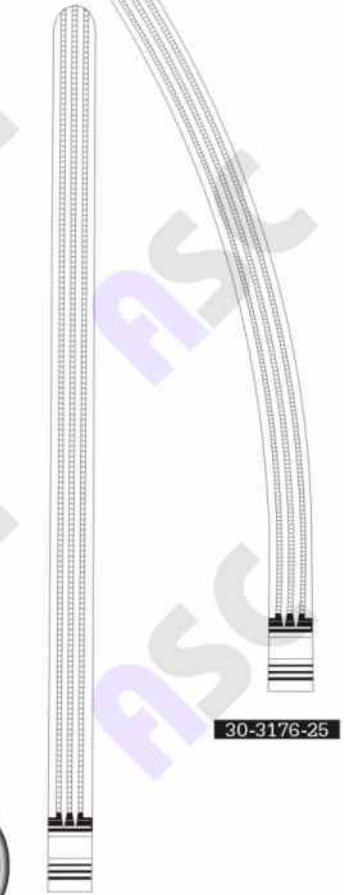

30-3175-25

30-3176-25

Atrauma Sigmoid Anastomosis Forceps  
Atrauma Rektum-Anastomosenklemmen  
Atrauma pinzas para anastomosis del recto



Atrauma Intestinal Clamps, Sigmoid Anastomosis Forceps  
Atrauma Darmklemmen, Rektum-Anastomosenklemmen  
Atrauma Pinzas intestinales, Pinzas para anastomosis rectales

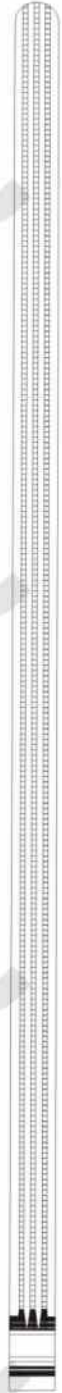

30-3195-33



Scudder-Atrauma  
33 cm / 13"



30-3196-33



Brunner



30-3201-24  
24 cm / 9½"

Stomach Clamp Forceps  
Magenklemmen  
Pinzas clamps estomacales

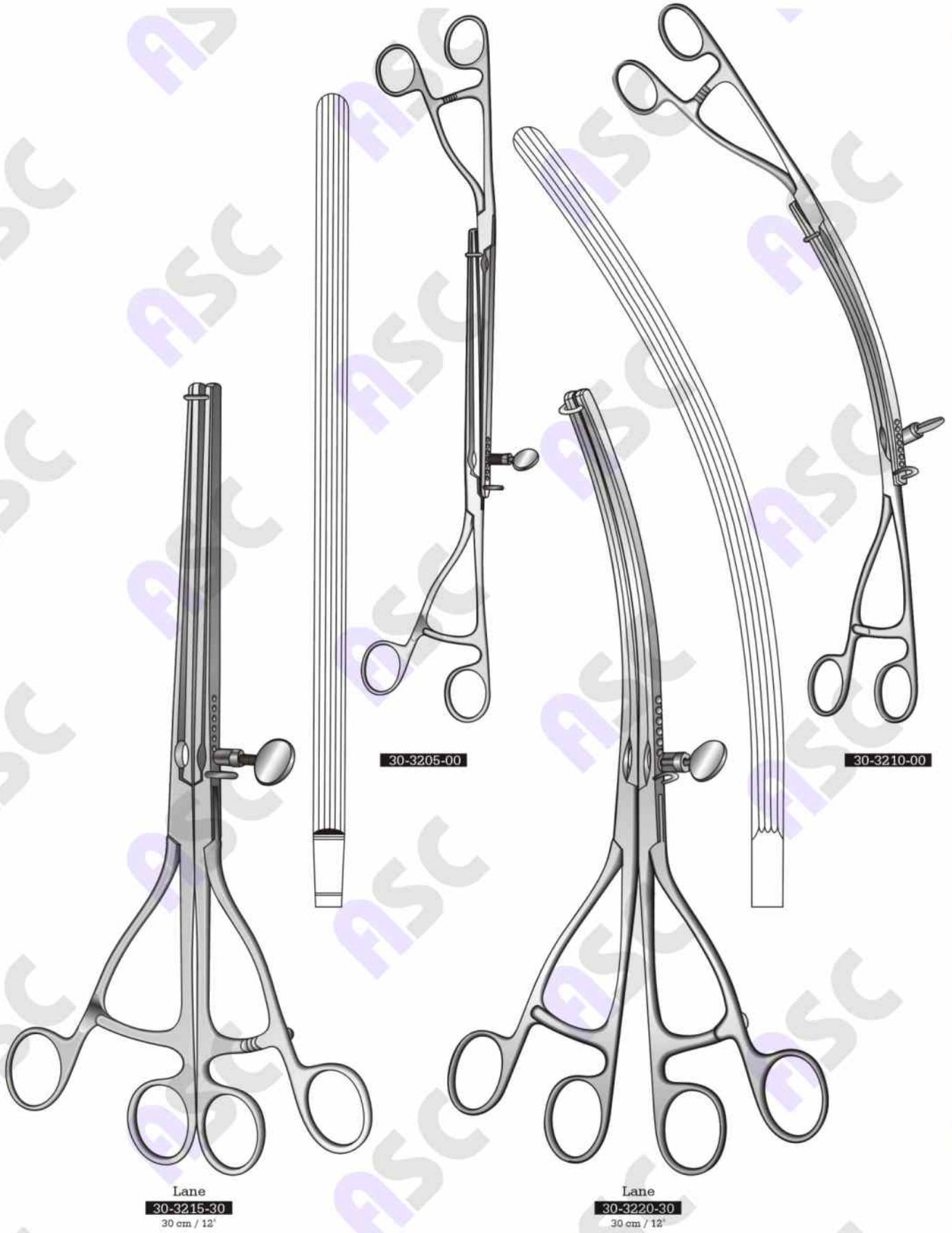



Intestinal and Pylorus Clamps  
Darmquetschklammen  
Pinzas intestinales para piloro



**Payr-Baby**  
**30-3225-15**  
15 cm / 6"  
With pin

**Payr**  
**30-3230-21** With pin  
**30-3231-21** Without pin  
21 cm / 8¼"

**Payr**  
**30-3235-29** With pin  
**30-3236-29** Without pin  
29 cm / 11½"

**Payr**  
**30-3240-35** With pin  
**30-3241-35** Without pin  
**30-3242-35** With groove  
35 cm / 14"

Intestinal and Anastomosis Clamp Forceps  
 Darmklemmen, Anastomosenklemmen  
 Pinzas clamps intestinales y para anastomosis

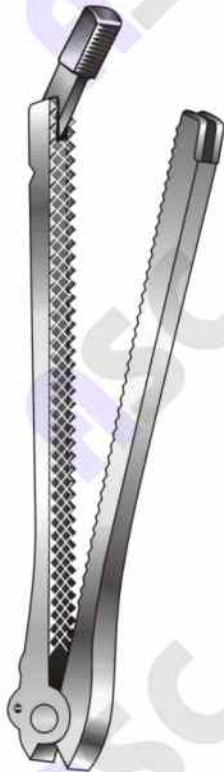

**DeMartel-Wolfson**  
 Anastomosis Clamps  
 Sets consist of  
 2 clamps with short grip  
 1 clamp with long grip



**30-3245-00**  
**30-3246-00**



**30-3275-00**

- 30-3250-05** Set of 5 cm / 2" long clamps
- 30-3251-05** 5 cm / 2" clamp with short grip
- 30-3252-05** 5 cm / 2" clamp with long grip
- 30-3255-07** Set of 7.5 cm / 3" long clamps
- 30-3256-07** 7.5 cm / 3" clamp with short grip
- 30-3257-07** 7.5 cm / 3" clamp with long grip
- 30-3260-10** Set of 10 cm / 4" long clamps
- 30-3261-10** 10 cm / 4" clamp with short grip
- 30-3262-10** 10 cm / 4" clamp with long grip
- 30-3265-08** Clamp holder, 8 cm / 3 1/4" long
- 30-3266-09** Clamp holder, 23 cm / 9", long
- 30-3270-00** Closing forceps

Fig. 2 30 x 10 mm  
Fig. 1 26 x 10 mm



Fig. 1 30 x 13 mm  
Fig. 2 34 x 13 mm

**Farabeuf**  
**15-0764-00**

12 cm / 4 3/4"  
Set of 2

Fig. 2 27 x 16 mm  
Fig. 1 23 x 16 mm



Fig. 1 26 x 16 mm  
Fig. 2 30 x 16 mm

**Farabeuf**  
**15-0766-00**

15 cm / 6"  
Set of 2

Fig. 2 21 x 14 mm  
Fig. 1 17 x 14 mm



Fig. 1 28 x 16 mm  
Fig. 2 32 x 16 mm

**Collin**  
**15-3001-15**

15 cm / 6"  
Set of 2

11 x 4 mm



19 x 6 mm

**Crile**  
**15-3005-11**

11 cm / 4 1/4"



**Mini-Roux**  
**15-0768-06**

14 cm / 5 1/2"



**Baby-Roux**  
**15-0770-13**

13 cm / 5 1/4"



**Roux**  
**15-0756-00** Set  
**15-0756-01** 14 cm / 5 1/2"  
**15-0756-02** 15 cm / 6"  
**15-0756-03** 17 cm / 6 3/4"  
**15-0756-04** 18 cm / 7"

Fig. 2 22 x 15 mm  
Fig. 1 19 x 15 mm



Fig. 1 19 x 15 mm  
Fig. 2 22 x 15 mm

**Parker**  
**15-0774-01**

Set of two

Retractors  
Wundhaken  
Separadores



Fig. 2 29 x 25 mm  
Fig. 1 26 x 25 mm

Fig. 1 24 x 25 mm  
Fig. 2 27 x 25 mm

**Parker**

**15-0774-02**

18 cm / 7"  
Set of 2

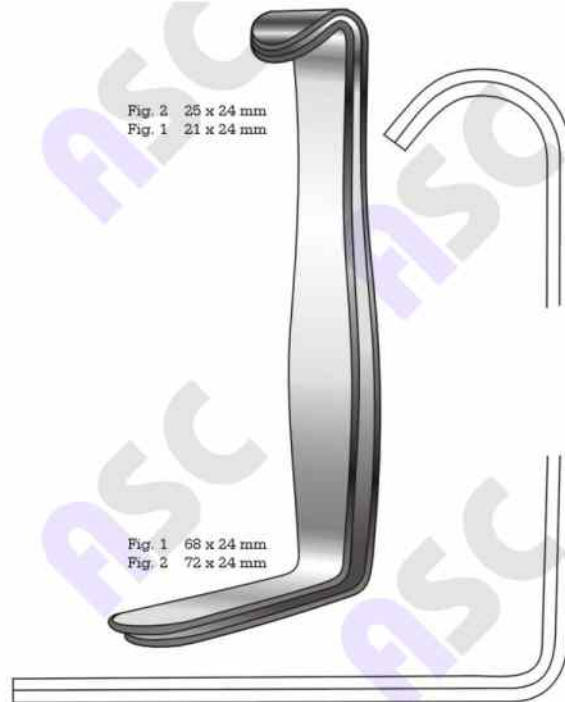

Fig. 2 25 x 24 mm  
Fig. 1 21 x 24 mm

Fig. 1 68 x 24 mm  
Fig. 2 72 x 24 mm

**Parker-Mott**

**15-3010-16**

16 cm / 6 1/4"  
Set of 2



Fig. 2 25 x 24 mm  
Fig. 1 21 x 24 mm

Fig. 1 40 x 15 mm  
Fig. 2 45 x 15 mm

**Parker-Langenbeck**

**15-3015-21**

21 cm / 8 1/4"  
Set of 2



Fig. 2 47 x 13 mm  
Fig. 1 41 x 13 mm

Fig. 1 37 x 25 mm  
Fig. 2 42 x 25 mm

**Mathieu**

**15-3020-20**

20 cm / 8"



36 mm

42 mm

**Czerny**

**15-3025-17**

17.5 cm / 7"



**Canny Ryoll**

**15-3030-16**

16 cm / 6 1/4"

**15-3030-20**

20 cm / 8"

**15-3030-25**

25 cm / 10"

**15-3030-30**

30 cm / 12"



**Goelet**  
15-0796-00  
19 cm / 7½"



40 x 40 mm

30 x 30 mm



15-3035-28 115 x 27 mm  
15-3036-28 115 x 22 mm

**Simon**  
28 cm / 11"



**Hibbs**  
15-3040-22  
22 cm / 8¾"  
25 x 75 mm blade



**Taylor**  
15-3045-18 18 cm / 7", 75 x 30 mm blade  
15-3045-20 20 cm / 8", 100 x 30 mm blade  
Spinal retractor

Retractors  
Wundhaken  
Separadores



Deaver  
**15-3050-18**  
18 cm / 7"  
19 mm

Deaver  
**15-3055-21**  
21.5 cm / 8½"  
22 mm

Deaver  
**15-3060-23**  
23 cm / 9"  
25 mm

Deaver  
**15-3065-30**  
30 cm / 12"  
25 mm

Deaver  
**15-3070-33**  
33 cm / 13"  
25 mm

Deaver  
**15-3075-36**  
36 cm / 14"  
25 mm



Deaver  
**15-3080-30**  
30 cm / 12"  
38 mm



Deaver  
**15-3085-30**  
30 cm / 12"  
50 mm

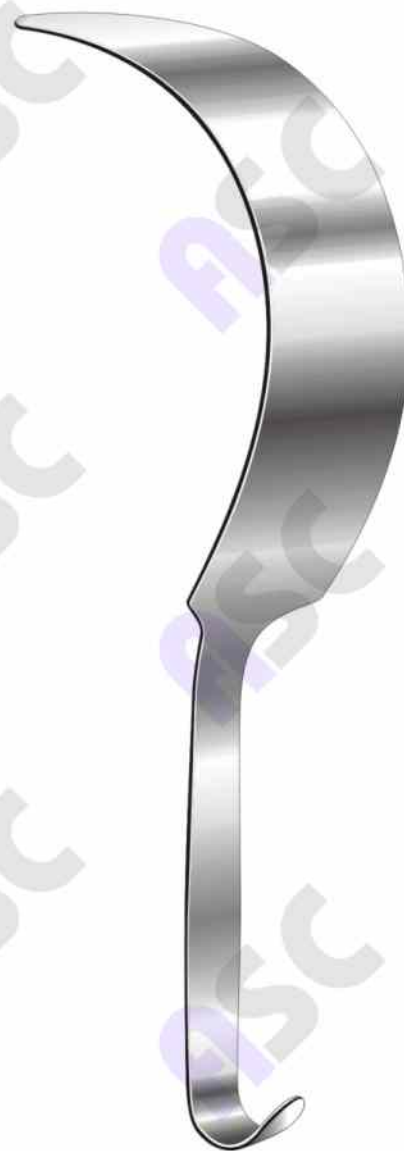

Deaver  
**15-3090-30**  
30 cm / 12"  
75 mm

Retractors  
Wundhaken  
Separadores

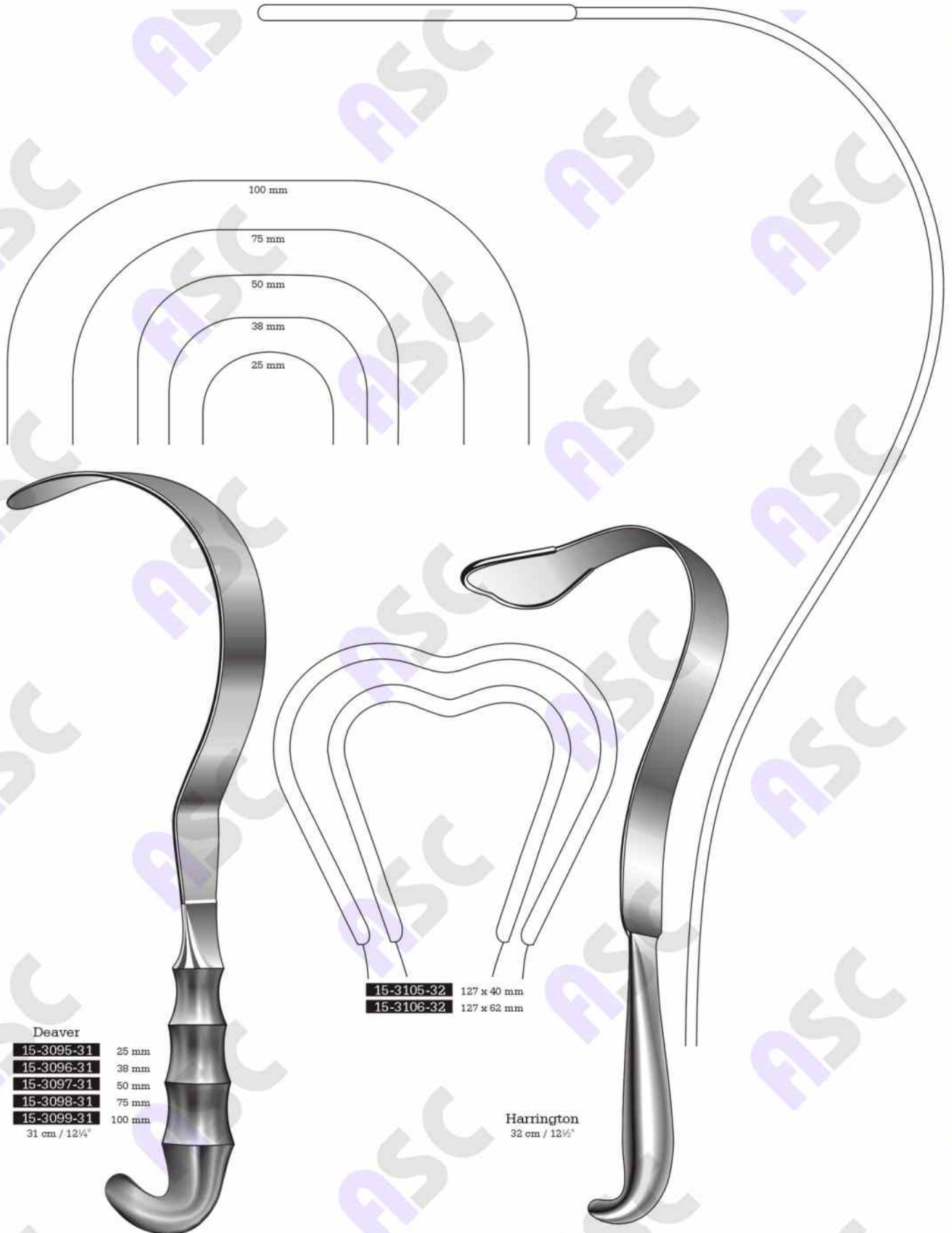

- Deaver**
- 15-3095-31** 25 mm
  - 15-3096-31** 38 mm
  - 15-3097-31** 50 mm
  - 15-3098-31** 75 mm
  - 15-3099-31** 100 mm
- 31 cm / 12¼"

- 15-3105-32** 127 x 40 mm
- 15-3106-32** 127 x 62 mm

**Harrington**  
32 cm / 12½"



Hooklets  
Wundhäkchen  
Ganchitos

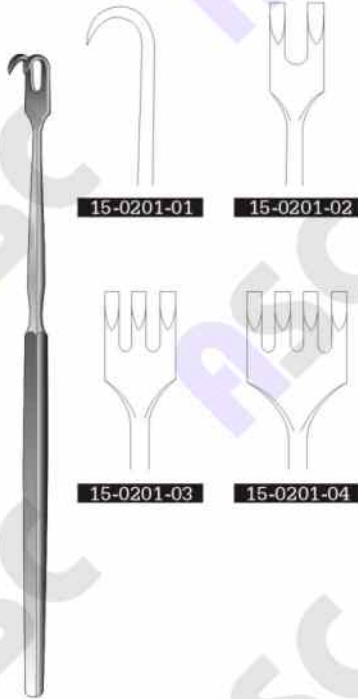

15-0201-01

15-0201-02



15-0201-03

15-0201-04

16 cm / 6¼"  
Sharp

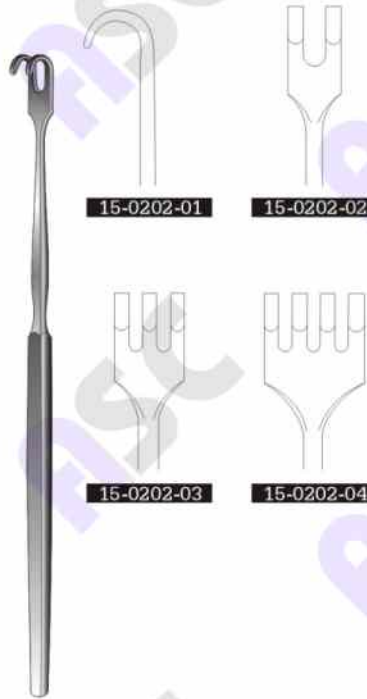

15-0202-01

15-0202-02

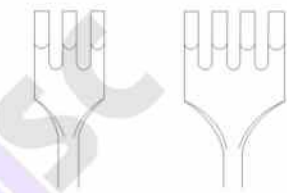

15-0202-03

15-0202-04

16 cm / 6¼"  
Blunt

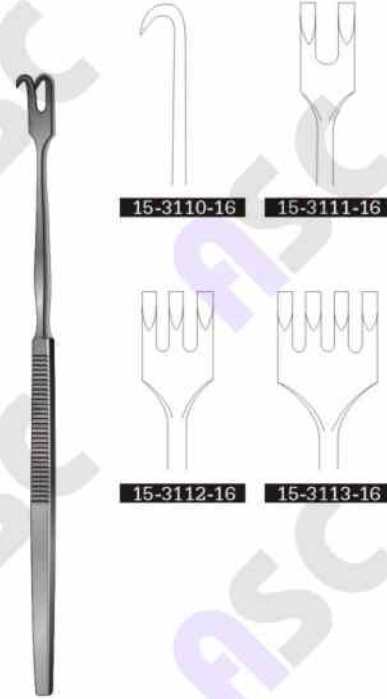

15-3110-16

15-3111-16

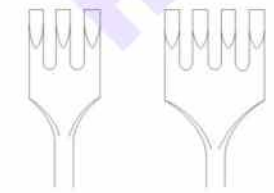

15-3112-16

15-3113-16

16 cm / 6¼"  
Sharp



15-3115-16

15-3116-16

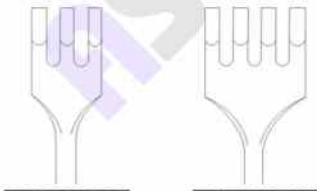

15-3117-16

15-3118-16

16 cm / 6¼"  
Blunt



15-3120-16

15-3125-16



15-3121-16

15-3126-16



15-3122-16

15-3127-16

Sharp

Blunt

16 cm / 6¼"  
Flexible

Micro Hooklets, Skin Hooks  
Mikrohäkchen, Hauthäkchen  
Micro ganchitos, Ganchitos de piel



Saddle Hooks, Hooklets  
Sattelhäkchen, Wundhäkchen  
Ganchos en forma de silla, Ganchitos



**Desmarres**

- 15-3150-16** 8 mm
  - 15-3151-16** 10 mm
  - 15-3152-16** 12 mm
  - 15-3153-16** 14 mm
  - 15-3154-16** 16 mm
  - 15-3155-16** 18 mm
- 16 cm / 6 1/4"



- 30-3160-16** 12 mm
  - 30-3161-16** 14 mm
  - 30-3162-16** 16 mm
  - 30-3163-16** 18 mm
- 16 cm / 6 1/4"



**Langenbeck-Green**  
16 cm / 6 1/4"



**15-3165-16**  
16 x 6 mm



**15-3166-16**  
24 x 6 mm



**Mini-Langenbeck**

- 15-3170-16** 10 x 6 mm
  - 15-3171-16** 17 x 5 mm
  - 15-3172-16** 20 x 6 mm
  - 15-3173-16** 22 x 8 mm
- 16 cm / 6 1/4"



**Cushing**  
20 cm / 8"



**15-3175-20**  
8 mm



**15-3180-20**  
10 mm



**15-3176-20**  
12 mm



**15-3181-20**  
14 mm



**15-3177-20**  
16 mm



**15-3182-20**  
18 mm



**Cushing**  
24 cm / 9 1/2"



**15-3185-24**  
8 mm



**15-3190-24**  
10 mm



**15-3186-24**  
12 mm



**15-3191-24**  
14 mm



**15-3187-24**  
16 mm



**15-3192-24**  
18 mm

Hooklets  
Wundhäkchen  
Ganchitos



**Ragnell-Davis**  
15-0265-14  
14 cm / 5½"



**Senn-Green**  
15 cm / 6"



15-0262-01  
10 x 6 mm



15-0262-02  
20 x 6 mm

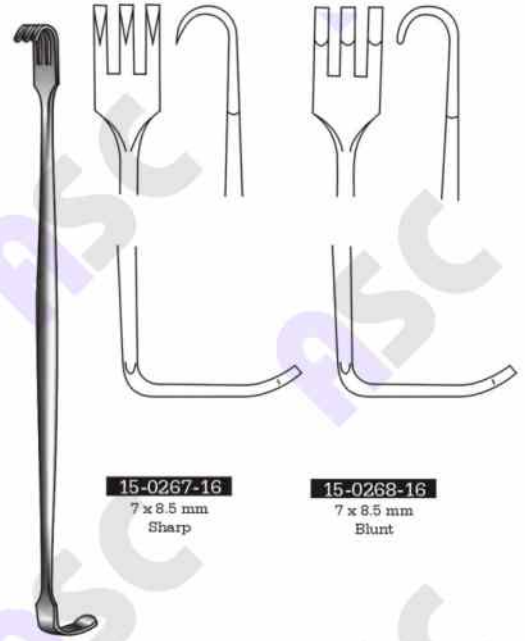

**Senn-Miller**  
16 cm / 6¼"

15-0267-16  
7 x 8.5 mm  
Sharp

15-0268-16  
7 x 8.5 mm  
Blunt



15-3195-00  
18 x 7 mm  
Fig. 1  
Blunt



15-3196-00  
16 x 5 mm  
Fig. 2  
Toothed



15-3197-00  
7 x 4 mm  
Fig. 3  
Toothed



**Meyerdig**  
18 cm / 7"



15-3198-00  
5 x 10 mm  
Fig. 4  
Sharp



15-3199-00  
11 x 4 mm  
Fig. 5  
Blunt



15-3200-00  
6 x 4 mm  
Fig. 6  
Saddle shaped



**Gil-Vernet**  
24 cm / 9½"  
Flexible shaft



15-3205-24  
8 mm



15-3210-24  
11 mm



15-3206-24  
15 mm



15-3211-24  
17 mm



15-3207-24  
20 mm



15-3212-24  
23 mm



Retractors  
Wundhaken  
Separadores



Murphy  
19 cm / 7½"  
Sharp



Murphy  
19 cm / 7½"  
Blunt



Kocher  
22 cm / 8½"





**15-3265-00**  
40 x 30 mm  
Sharp



**Koerte**  
**15-3270-23**  
23.5 cm / 9 1/4"  
40 x 30 mm  
blunt



**Israel**  
25 cm / 10"

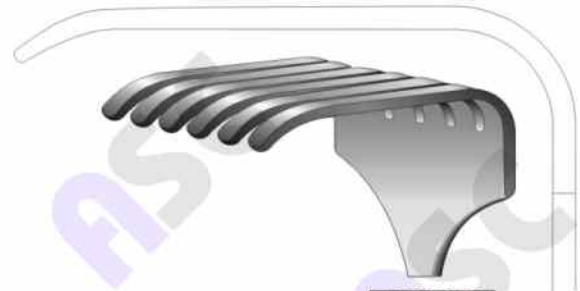

**15-3278-25**  
70 x 70 mm

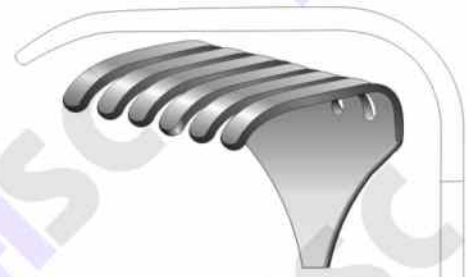

**15-3277-25**  
50 x 60 mm

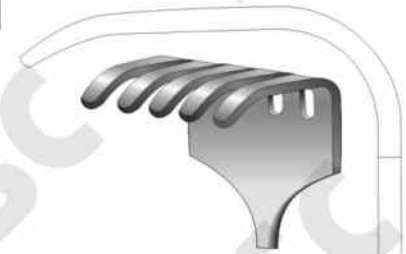

**15-3276-25**  
45 x 50 mm



**15-3275-25**  
40 x 40 mm

Retractors  
Wundhaken  
Separadores



Langenbeck  
21 cm / 8 1/4"

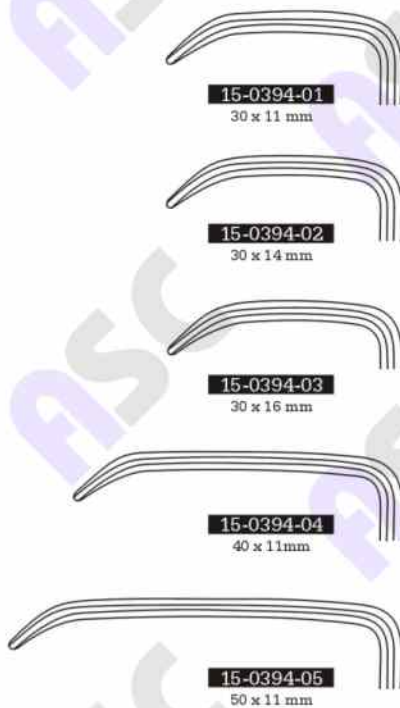

Langenbeck  
22 cm / 8 1/2"

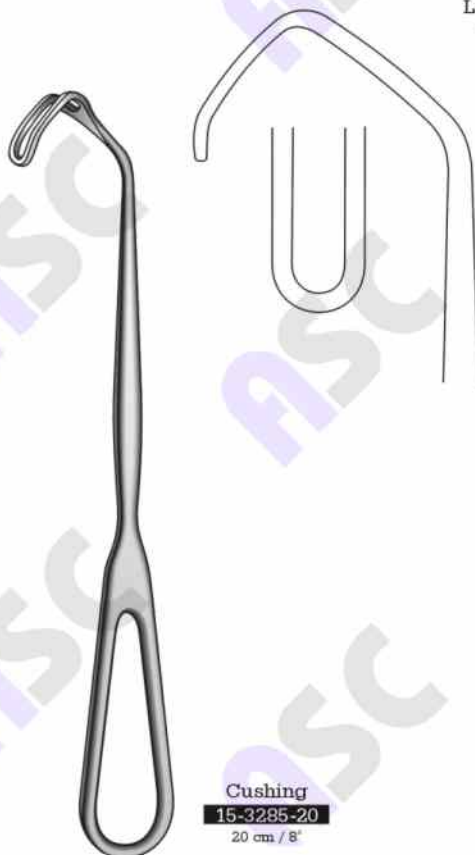
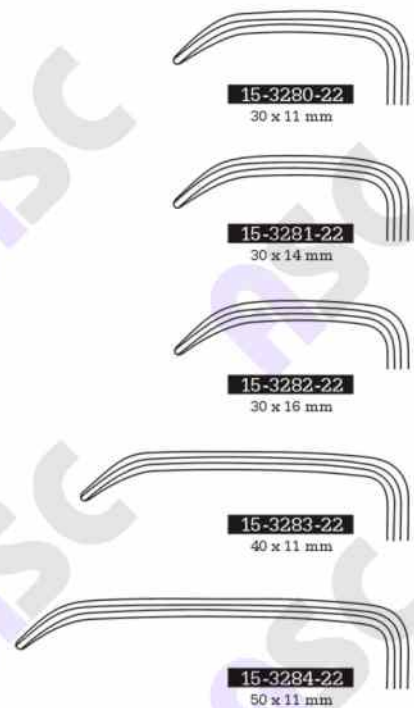

Cushing  
15-3285-20  
20 cm / 8"



Langenbeck  
15-3290-00 22 x 6 mm  
15-3291-00 44 x 13 mm



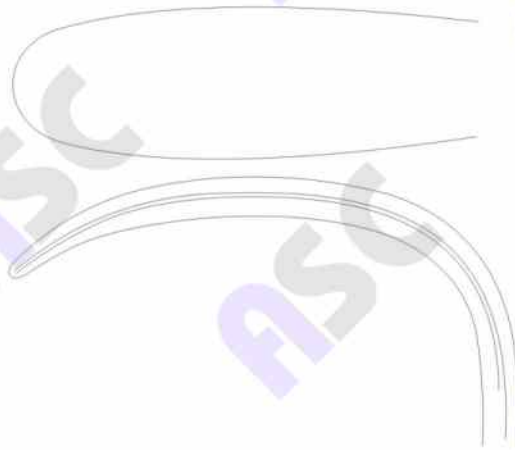

15-3305-23	40 x 18 mm
15-3306-23	60 x 20 mm
15-3307-23	60 x 25 mm
15-3308-23	75 x 30 mm
15-3309-23	75 x 40 mm



**Langenbeck**  
15-3295-21  
21 cm / 8¼"  
85 x 15 mm



**Langenbeck**  
15-3300-21  
21 cm / 8¼"  
60 x 20 mm



**Kocher**  
23 cm / 9"

Retractors  
Wundhaken  
Separadores

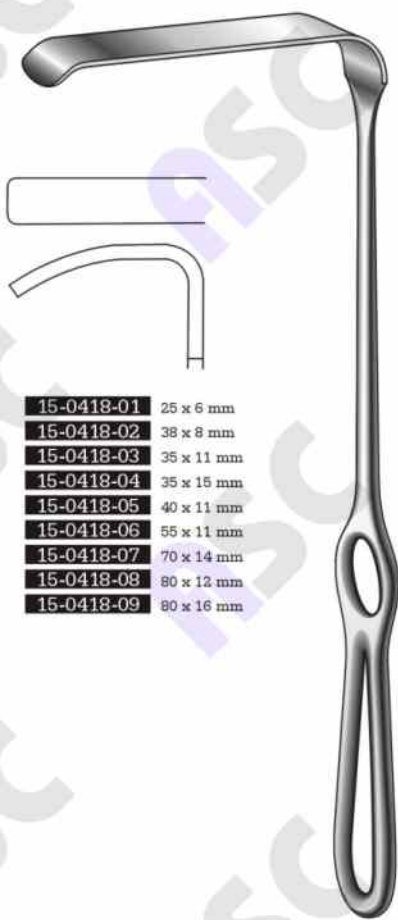

Kocher-Langenbeck  
21.5 cm / 8 1/2"



Morris  
 15-3315-00 40 mm  
 15-3316-00 50 mm  
 15-3317-00 65 mm



Morris  
 15-3320-00 30 x 40 mm  
 15-3321-00 45 x 50 mm  
 15-3322-00 55 x 60 mm



**15-0462-01**  
21.5 cm / 8½"  
14 x 17 mm



Ollier  
**15-3325-22**  
22.5 cm / 9"  
36 x 30 mm



**15-3335-25**  
45 x 45 mm



**15-0462-02**  
22 cm / 8¾"  
20 x 22 mm



**15-3336-25**  
45 x 50 mm



Middeldorpf



**15-0462-03**  
23.5 cm / 9½"  
26 x 30 mm



Ollier  
**15-3330-22**  
22.5 cm / 9"  
36 x 60 mm



Middeldorpf  
25.5 cm / 10"



**15-3337-25**  
55 x 70 mm

Retractors  
Wundhaken  
Separadores

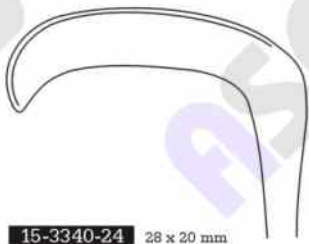

15-3340-24 28 x 20 mm  
15-3341-24 36 x 28 mm  
15-3342-24 44 x 38 mm



**Richardson**  
24 cm / 9½"



**Richardson**  
15-3345-24  
24 cm / 9½"  
52 x 22 mm



**Kelly**  
15-3350-26 50 x 35 mm  
15-3351-26 65 x 50 mm  
15-3352-26 75 x 65 mm  
26 cm / 10¼"

Fig. 2 49 x 38 mm  
Fig. 1 28 x 20 mm

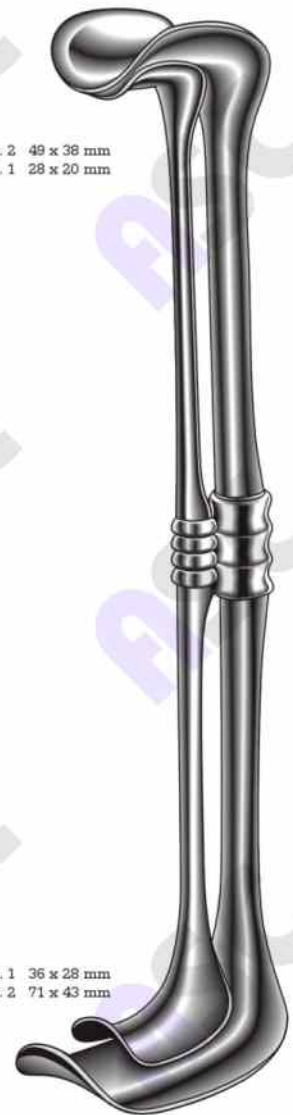

Fig. 1 36 x 28 mm  
Fig. 2 71 x 43 mm

**Richardson-Eastman**  
15-3355-26 26 cm / 10¼", Fig.1  
15-3355-28 28 cm / 11", Fig.2  
15-3355-30 Set of 2, Fig.1 & Fig.2



Saurbruch

15-3360-00  
75 x 15 mm



15-3362-00  
45 x 20 mm



15-3361-00  
60 x 23 mm



Fritsch  
15-3365-24  
24 cm / 9½"  
40 x 40 mm



Fritsch  
15-3370-24 45 x 40 mm  
15-3371-24 45 x 50 mm  
15-3372-24 45 x 60 mm  
15-3373-24 45 x 75 mm  
24 cm / 9½"



Doyen  
15-3375-25  
25 cm / 10"  
50 x 85 mm

Retractors  
Wundhaken  
Separadores



Tuffier  
15-3380-23  
23 cm / 9"



Koerte  
15-3385-28  
28 cm / 11"  
120 x 47 mm  
Rigid



15-3391-27  
45 x 25 mm



15-3392-27  
73 x 28 mm

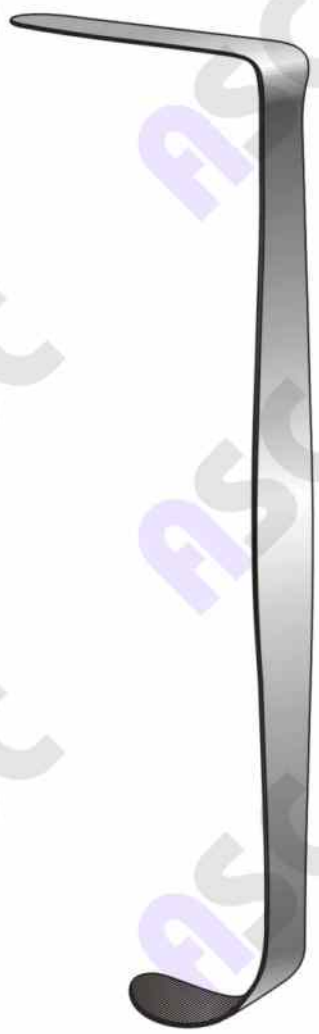

Heaney  
15-3390-27  
82 x 28 mm  
27 cm / 10 3/4"

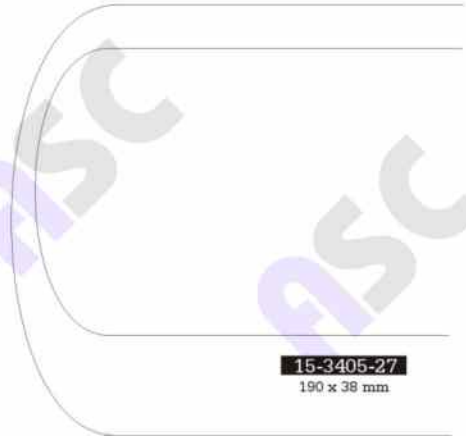

**15-3405-27**  
190 x 38 mm

**15-3406-27**  
190 x 57 mm



**Mikulicz**  
**15-3395-26**  
26 cm / 10 1/4"  
90 x 50 mm



**Mikulicz**  
**15-3400-26** 95 x 35 mm  
**15-3401-26** 120 x 50 mm  
**15-3402-26** 150 x 50 mm  
26 cm / 10 1/4"



**Kelly**  
27 cm / 10 1/2"

Retractors  
Wundhaken  
Separadores



**Meyerding**  
For deep surgery

**15-3410-25**  
25.5 cm / 10"  
89 x 50 mm



**15-3410-23**  
23 cm / 9"  
76 x 25 mm



**15-3410-21**  
21 cm / 8 1/2"  
52 x 16 mm



**Davidson**  
**15-3415-16** 75 x 50 mm  
**15-3416-16** 75 x 90 mm  
15 cm / 6 1/4"  
Soapula retractor



65 x 45 mm

**Dartigues**  
**15-3420-00**



Pelvis Retractors  
Beckenhaken  
Separadores para pelvis



Retractors  
Wundhaken  
Separadores



**Throkson**  
**15-3440-33** 40 x 170 mm  
**15-3441-33** 50 x 170 mm  
**15-3442-33** 65 x 170 mm  
33 cm / 13"



**Throkson**  
**15-3445-33** 40 x 170 mm  
**15-3446-33** 50 x 170 mm  
**15-3447-33** 65 x 170 mm  
33 cm / 13"

Wound Spreaders  
Wundspreizer  
Separadores autoestáticos

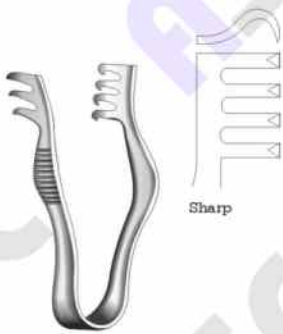

**Finsen**  
15-3450-07  
15-3455-07  
7 cm / 2 3/4"



**Finsen**  
15-3451-07  
15-3456-07  
7 cm / 2 3/4"  
With adjusting screw



15-3460-08  
8 cm / 3 1/4"



**Buckley**  
15-3465-06  
6 cm / 2 1/2"



15-3470-07 7 cm / 2 3/4"  
15-3470-10 10 cm / 4"  
Sharp  
15-3471-07 7 cm / 2 3/4"  
15-3471-10 10 cm / 4"  
Blunt

Alm

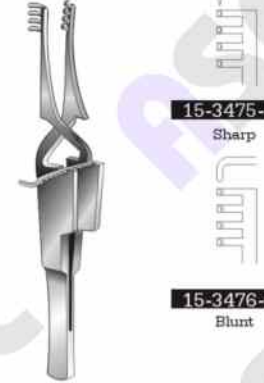

15-3475-10  
Sharp

10 cm / 4"

15-3476-00  
Blunt



**Jansen**  
10 cm / 4"

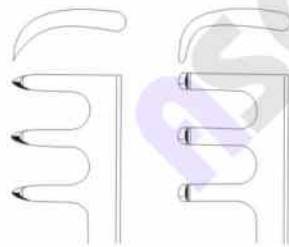

15-3480-10  
Sharp

15-3481-10  
Blunt



**Jansen-Wagner**  
15-3485-10  
10 cm / 4"

Retractors  
Wundhaken  
Separadores

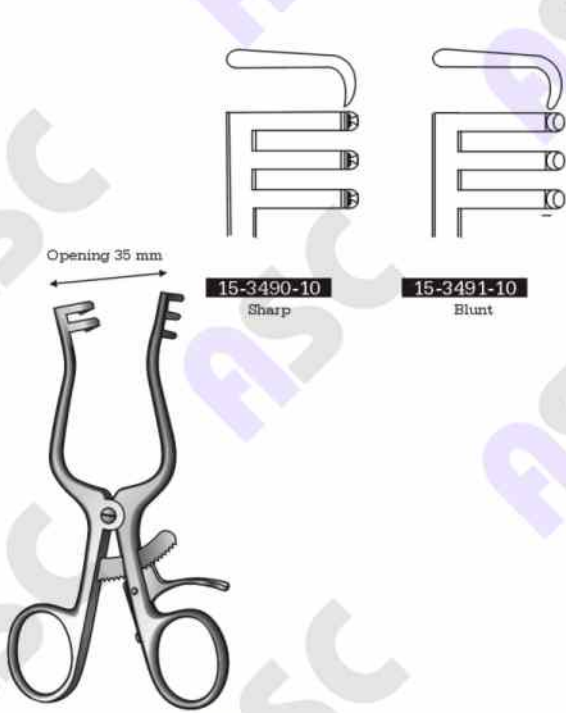

Opening 35 mm

**15-3490-10**  
Sharp

**15-3491-10**  
Blunt

**Weitlaner**  
10.5 cm / 4 1/4"  
2:3 Teeth

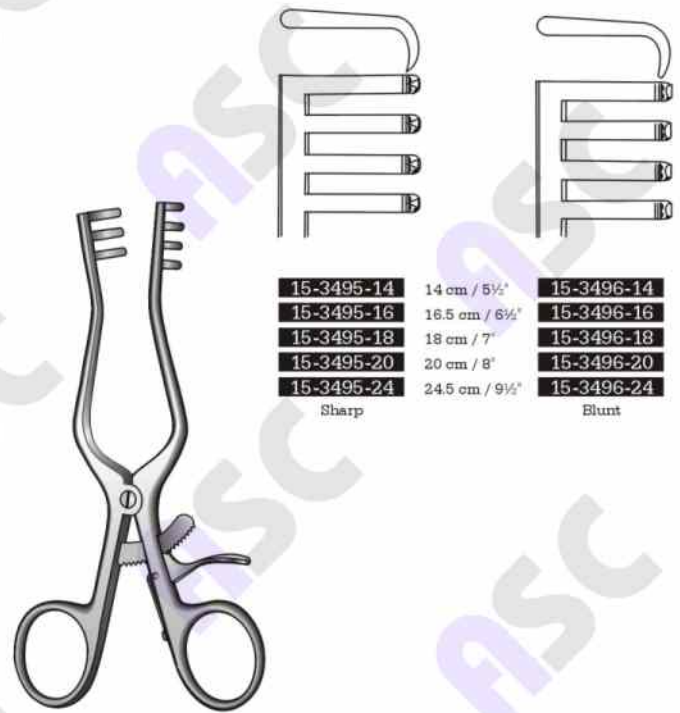

**15-3495-14** 14 cm / 5 1/2"  
**15-3495-16** 16.5 cm / 6 1/2"  
**15-3495-18** 18 cm / 7"  
**15-3495-20** 20 cm / 8"  
**15-3495-24** 24.5 cm / 9 1/2"  
Sharp

**15-3496-14**  
**15-3496-16**  
**15-3496-18**  
**15-3496-20**  
**15-3496-24**  
Blunt

**Weitlaner**  
3:4 Teeth

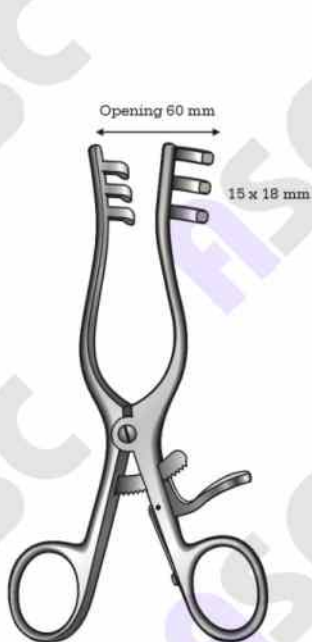

Opening 60 mm

15 x 18 mm

**West**  
**15-3500-13**  
13 cm / 5 1/4"  
3:3 Teeth

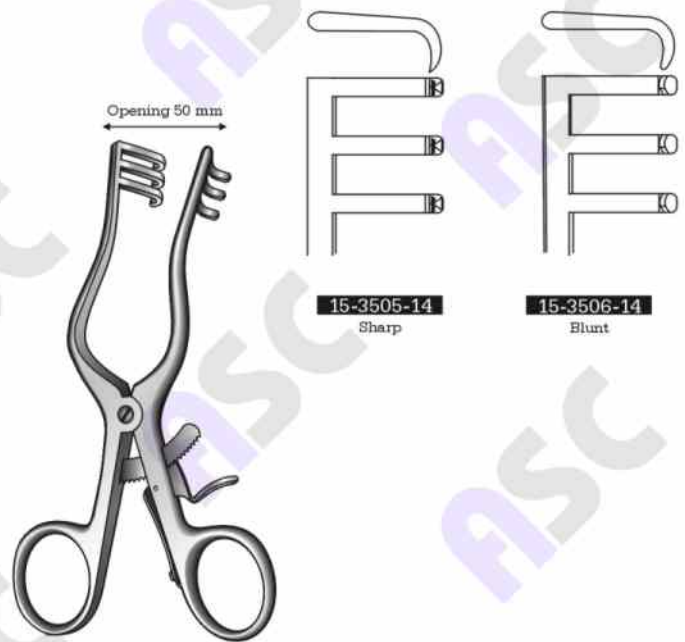

Opening 50 mm

**15-3505-14**  
Sharp

**15-3506-14**  
Blunt

**Weitlaner-Wullstein**  
14 cm / 5 1/2"  
3:3 Teeth

Wound Spreaders  
Wundspreizer  
Separadores autoestáticos



**Weitlania**  
**15-3510-14**  
14 cm / 5½"

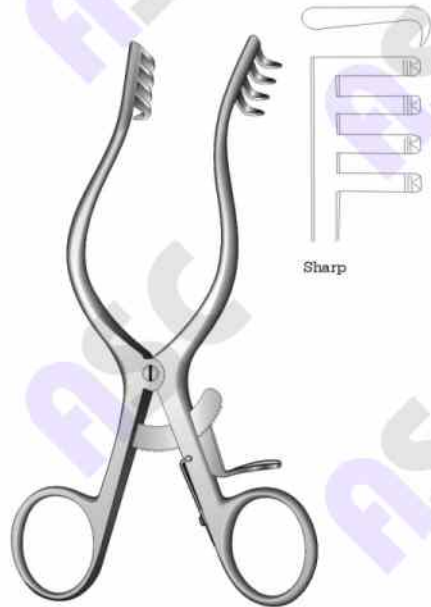

**Mollison**  
**15-3515-15**  
15 cm / 6"  
4:4 Teeth

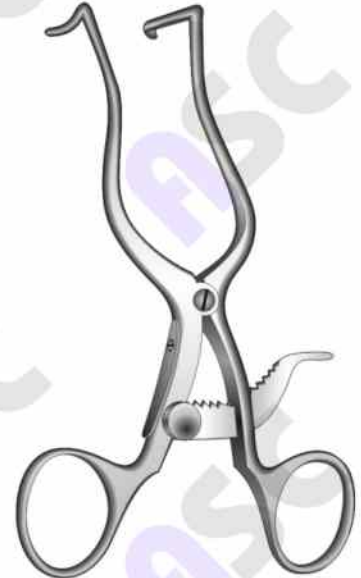

**Cloward**  
**15-3520-13**  
13.5 cm / 5¼"  
Blunt

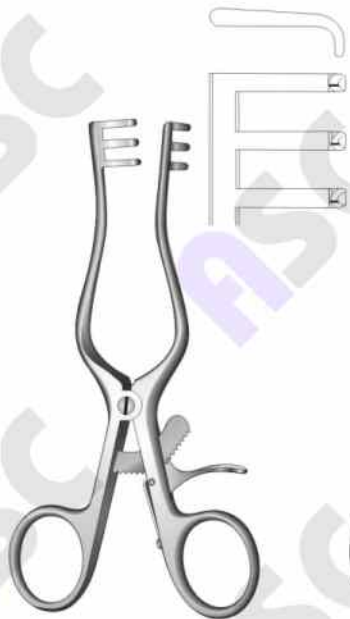

**Milligan**  
**15-3525-13**  
13 cm / 5"  
Blunt



**Plester**  
**15-3530-11**  
11 cm / 4¼"  
Blunt  
2 Teeth



**Plester**  
**15-3535-11**  
11 cm / 4¼"  
Blunt  
2 Teeth



**Cloward**  
**15-3540-13**  
13.5 cm / 5¼"  
Blunt

Handheld Retractors  
Wundhaken  
Separadores

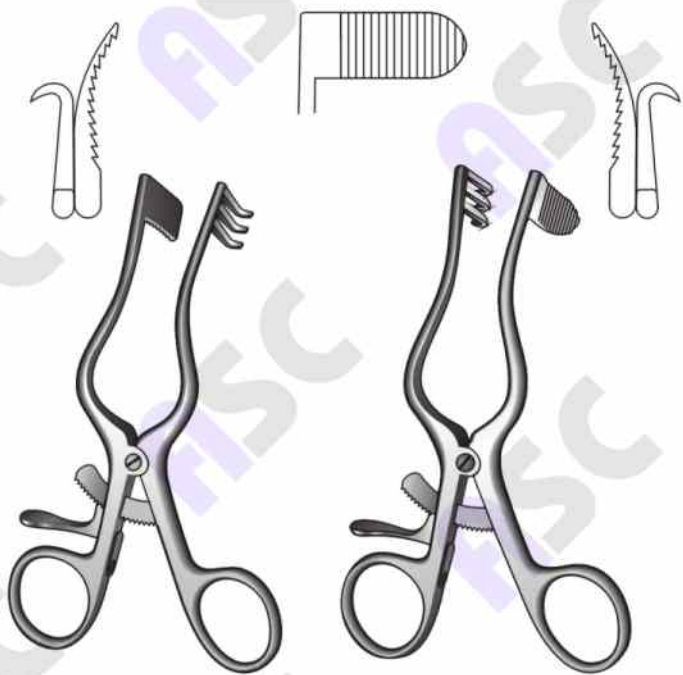

Perkins  
**15-3545-13**  
13 cm / 5"



Perkins  
**15-3550-13**  
13 cm / 5"



Plester  
**15-3560-14**  
14 cm / 5 1/2"  
Blunt



Norfolk-Norwich  
**15-3565-22**  
22 cm / 8 1/2"  
Blunt



Travers  
**15-3570-20**  
20 cm / 8"



Adson-Baby / Cone  
**15-3575-13**    **15-3576-13**  
13 cm / 5 1/4"    13 cm / 5 1/4"  
Sharp                      Blunt



Adson-Baby / Cone  
**15-3580-16**    **15-3581-16**  
16 cm / 6 1/4"    16 cm / 6 1/4"  
Sharp                      Blunt

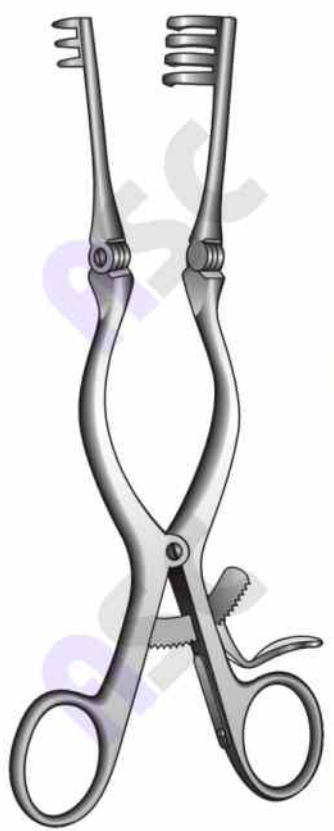

Adson / Cone  
**15-3585-20**  
20 cm / 8"  
Sharp

Wound Spreaders  
Wundspreizer  
Separadores autoestáticos



Adson

15-3590-26	3 x 4	15-3595-26
15-3591-26	4 x 4	15-3596-26
15-3592-26	6 x 6	15-3597-26
26.5 cm / 10½"		26.5 cm / 10½"
Sharp		Blunt



Adson Baby

15-3600-14	14 cm / 5½"	15-3605-14
15-3600-16	16 cm / 6½"	15-3605-16
15-3600-20	20 cm / 8"	15-3605-20
3:4 Teeth		3:4 Teeth
Sharp		Blunt



Harvey Jackson

15-3610-28
28 cm / 11"
Sharp

Wound Spreaders  
Wundspreizer  
Separadores autoestáticos

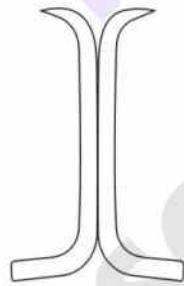

Anderson-Adson  
**15-3620-19**  
19.5 cm / 7 1/2"  
Sharp

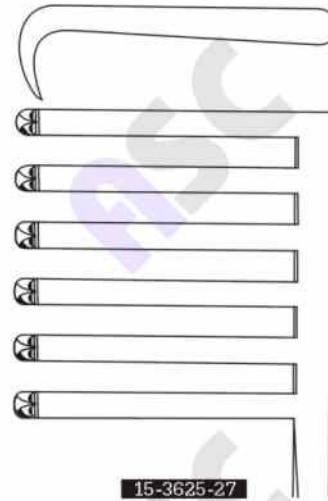

**15-3625-27**  
6:6 Teeth  
Sharp, long teeth on left side

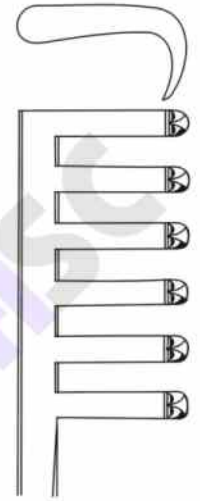

Adson  
**15-3615-19** Sharp  
19 cm / 7 1/2"  
**15-3615-20** Blunt  
20 cm / 8"



Hemi-Laminectomy Retractor



**15-3626-27**  
6:6 Teeth  
Sharp, long teeth on Right side



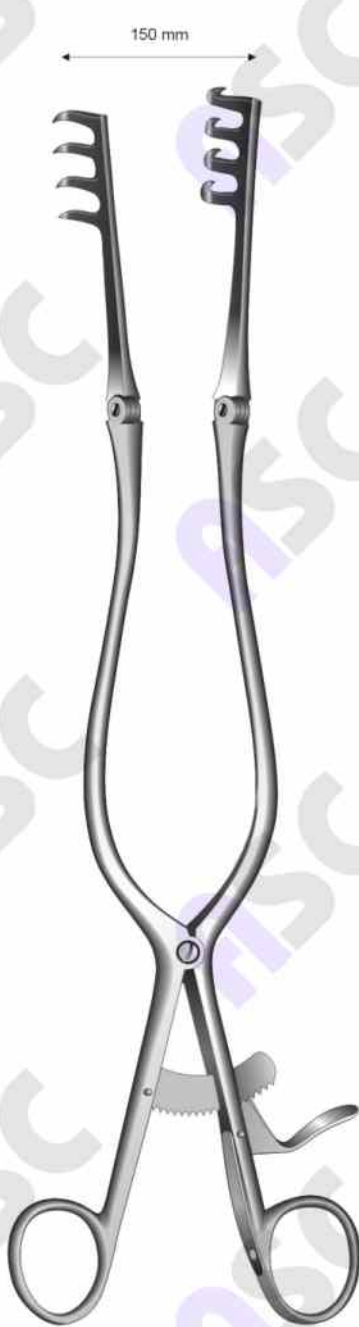

**Beckmann**  
**15-3630-31**  
31 cm / 12 1/4"  
4:4 Teeth  
Sharp



**Adson**  
**15-3635-32**  
32 cm / 12 1/2"  
4:6 Teeth  
Blunt



<b>15-3640-31</b>	28 x 28 mm	<b>15-3645-31</b>
<b>15-3641-31</b>	44 x 28 mm	<b>15-3646-31</b>
31 cm / 12 1/4"		31 cm / 12 1/4"
4:4 Teeth		4:4 Teeth
Sharp		Blunt

Wound Spreaders  
Wundspreizer  
Separadores autoestáticos

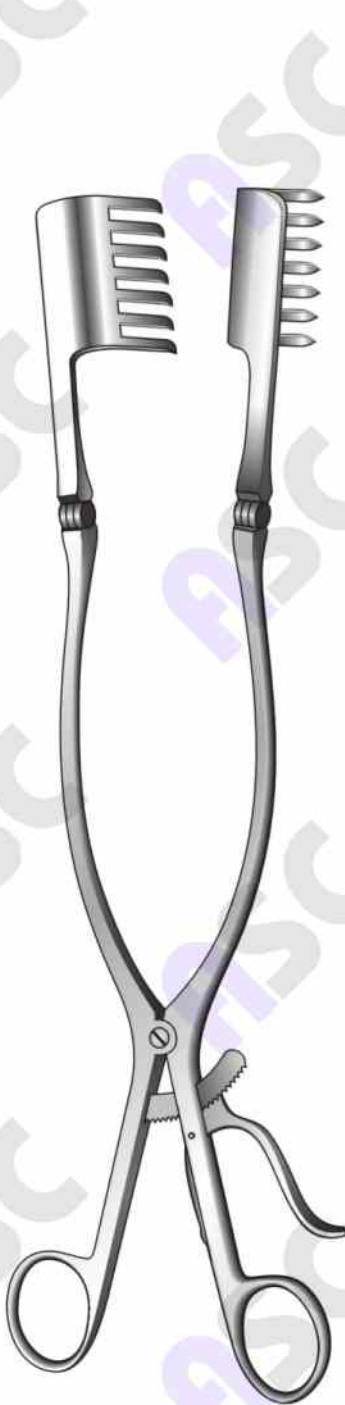

Beckmann-Eaton  
15-3650-32  
32 cm / 12½"

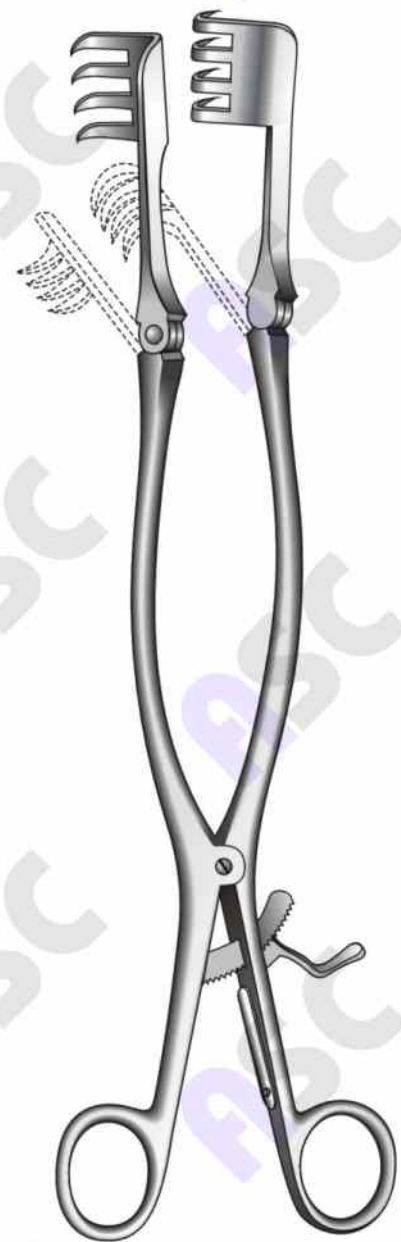
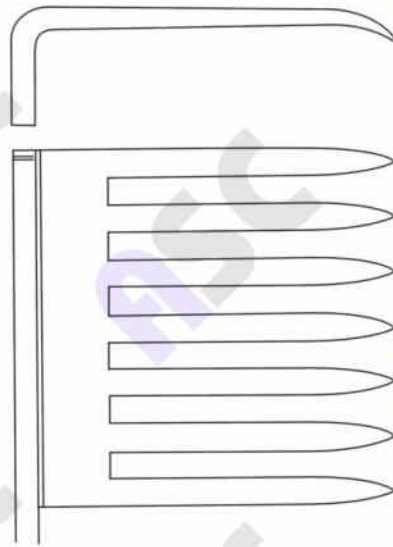

Beckmann  
15-3655-31  
31 cm / 12¼"



Gelpi

- 15-3660-09** 9 cm / 3½"
- 15-3660-11** 11.5 cm / 4½"
- 15-3660-14** 14 cm / 5½"
- 15-3660-16** 16 cm / 6¼"
- 15-3660-18** 18 cm / 7"
- 15-3660-20** 20 cm / 8"



Gelpi

- 15-3665-09** 9 cm / 3½"
- 15-3665-11** 11.5 cm / 4½"
- 15-3665-14** 14 cm / 5½"
- 15-3665-16** 16 cm / 6¼"
- 15-3665-18** 18 cm / 7"



Gelpi

- 15-3670-18**  
18 cm / 7"



Opening 100 mm

60 x 20 mm

Rigby

- 15-3675-18**  
18 cm / 7"



Opening 75 mm

30 x 16 mm

Mayo-Adams

- 15-3680-17**  
17 cm / 6¼"

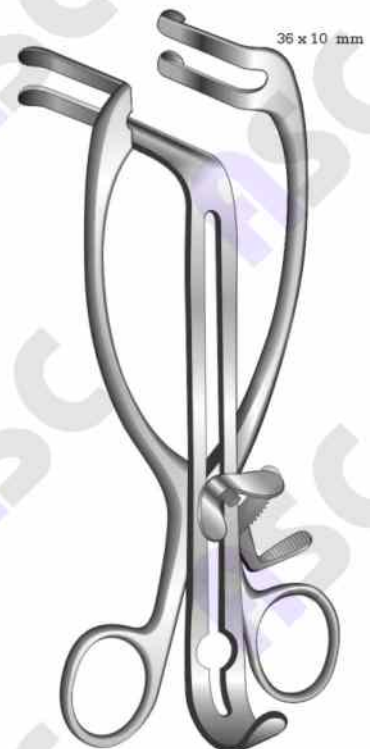

36 x 10 mm

Mayo-Adams

- 15-3685-17**  
17 cm / 6¼"  
With center blade

Retractors  
Wundhaken  
Separadores



**Meyerding**

- 15-3690-00** 25 x 60 mm blade
- 15-3691-00** 25 x 55 mm blade
- 15-3692-00** 25 x 35 mm blade
- 15-3693-00** 22 x 60 mm blade



**Darling**

- 15-3695-18**
- 18 cm / 7"
- (Poplitea)



**Darling**

- 15-3700-18**
- 18 cm / 7"
- (Poplitea)

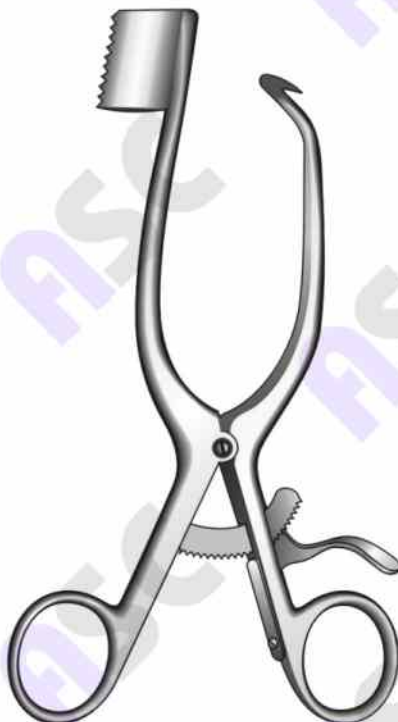

**Spikel Shield**

- 15-3705-12** 12.5 cm / 5"
  - 15-3705-18** 18 cm / 7"
- Left



**Spikel Shield**

- 15-3710-12** 12.5 cm / 5"
  - 15-3710-18** 18 cm / 7"
- Right

Abdominal Retractors  
Bauchdeckenhalter  
Separadores abdominales



**Collin, Baby**  
**15-3715-20**  
20 cm / 8"  
Complete with 2 pairs of lateral blades  
(18 x 40 mm), (27 x 40 mm)



**Oettingen**  
**15-3720-15**  
Lateral Blades 38 x 80 mm  
Center blades 50 x 65 mm  
Blade opening 150 mm / 6"



**Collin**  
**15-3725-25** With center blade  
**15-3726-25** Without center blade  
25 cm / 10"  
**15-3730-28** With center blade  
**15-3731-28** Without center blade  
28 cm / 11"



**Holzbach**  
**15-3735-00** Complete  
**15-3736-00** Spreader only  
**15-3737-00** 59 x 80 mm lateral blades  
**15-3738-00** 74 x 82 mm center blade

Retractors  
Wundhaken  
Separadores

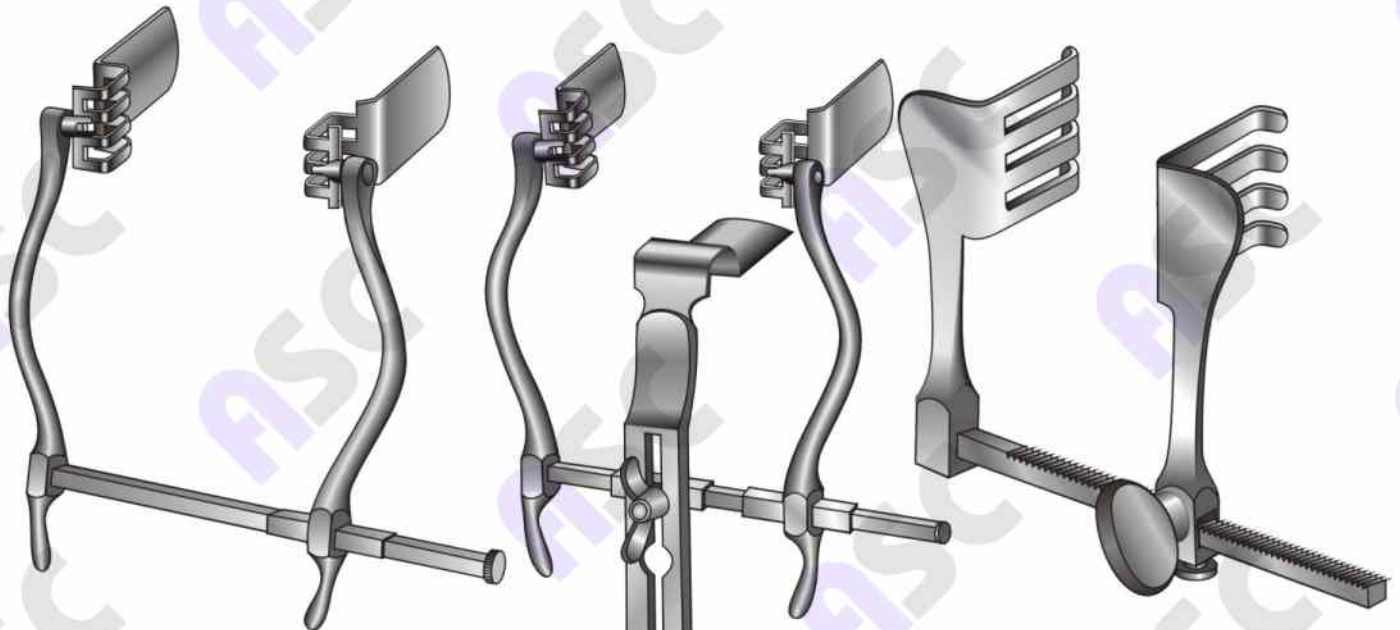

**Masson-Judd**  
**15-3740-00**  
Bladder retractor with  
2 swivel blades 25 x 70 mm

**Masson-Judd**  
**15-3745-00**  
Blades Retractor with  
2 swivel blades,  
center blade 25 x 70 mm

**Badgley**  
**15-3750-16**  
50 x 44 mm  
16 cm / 6 1/4"  
Spread



**Frazier**  
**15-3755-08**  
8 cm / 3 1/4"  
Spread  
Laminectomy Retractor

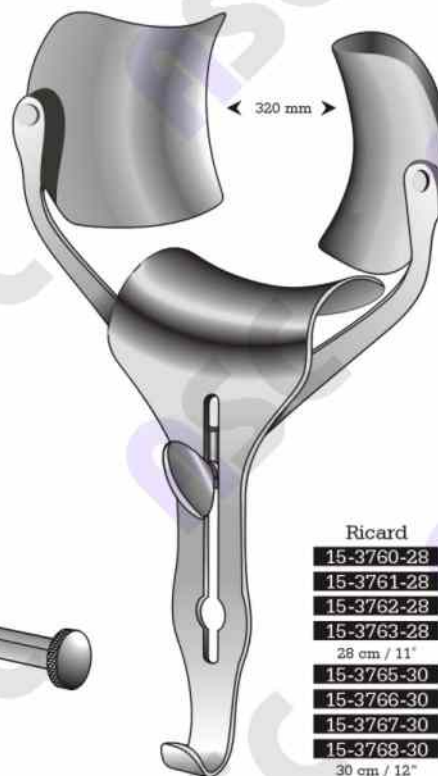

**Ricard**  
**15-3760-28** Complete set  
**15-3761-28** Spreader only  
**15-3762-28** 55 x 70 mm center blade  
**15-3763-28** 50 x 58 mm lateral blades  
28 cm / 11"  
**15-3765-30** Complete set  
**15-3766-30** Spreader only  
**15-3767-30** 80 x 90 mm center blade  
**15-3768-30** 60 x 80 mm lateral blades  
30 cm / 12"

Abdominal Retractors  
Bauchdeckenhalter  
Separadores abdominales

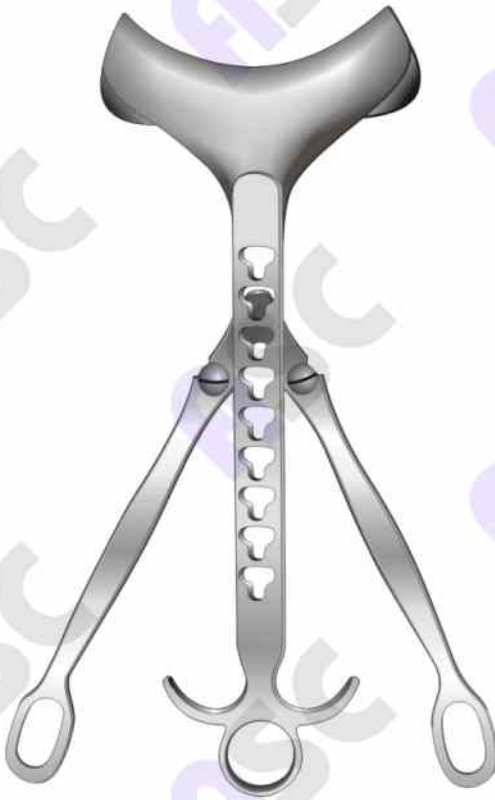

**Rochard**  
**15-3770-31** 48 x 90 mm  
**15-3771-31** 48 x 105 mm  
**15-3772-31** 48 x 120 mm  
**15-3773-31** 48 x 135 mm  
**15-3774-31** 48 x 155 mm  
 31 cm / 12 1/4"



**Rochard**  
**15-3775-19**  
 19 cm / 7 1/2"  
 Fixation device for  
 15-3770-31 - 15-3774-31



**Doyen**  
**15-3780-28** 48 x 90 mm  
**15-3781-28** 48 x 105 mm  
**15-3782-28** 48 x 120 mm  
**15-3783-28** 48 x 135 mm  
 28 cm / 11"

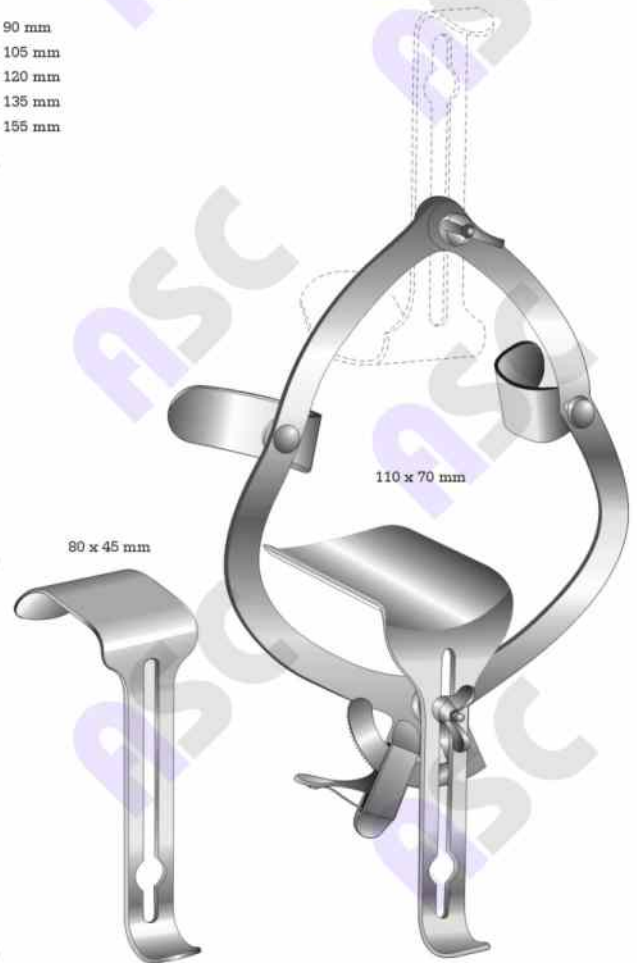

**O' Sullivan-O' Connor**  
**15-3785-00**  
 Adult  
**15-3786-00**  
 Baby

Abdominal Retractors  
Bauchdeckenhalter  
Separadores abdominales



Gosset-Baby  
15-3790-00

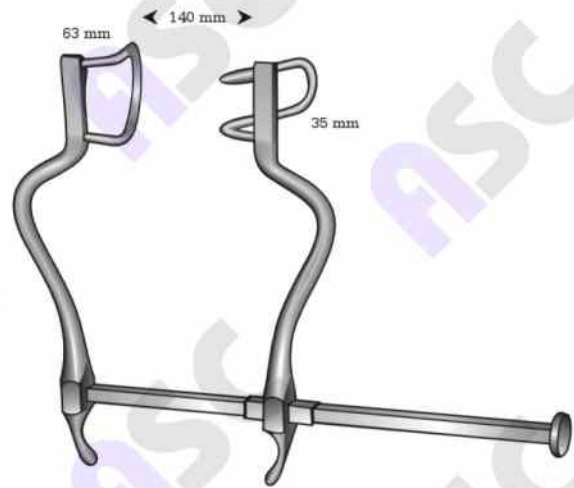

Gosset  
15-3795-00



Gosset  
15-3800-00

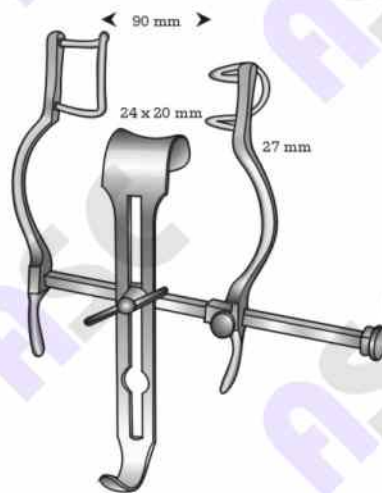

Balfour-Baby  
15-3805-00 Single bar  
15-3806-00 Double bar



Abdominal Retractors  
Bauchdeckenhalter  
Separadores abdominales



Pantings  
15-3810-00

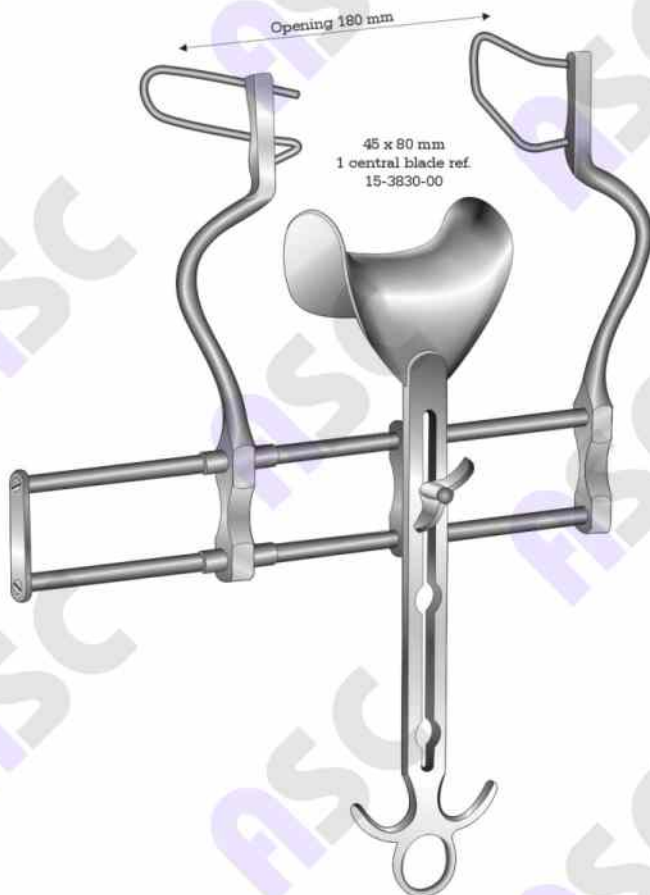

Balfour  
15-3815-00

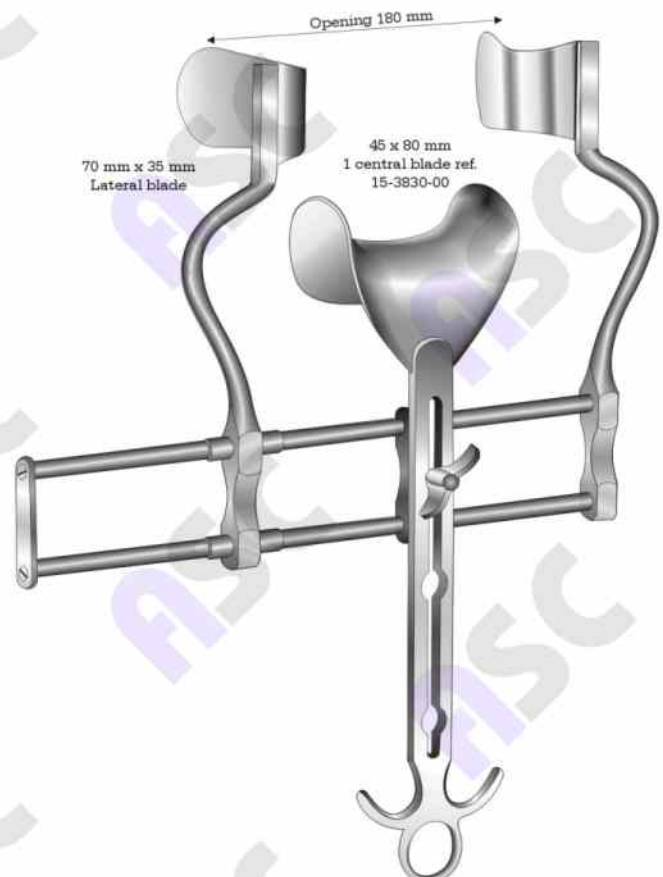

Balfour  
15-3820-00

Abdominal Retractors  
Bauchdeckenhalter  
Separadores abdominales

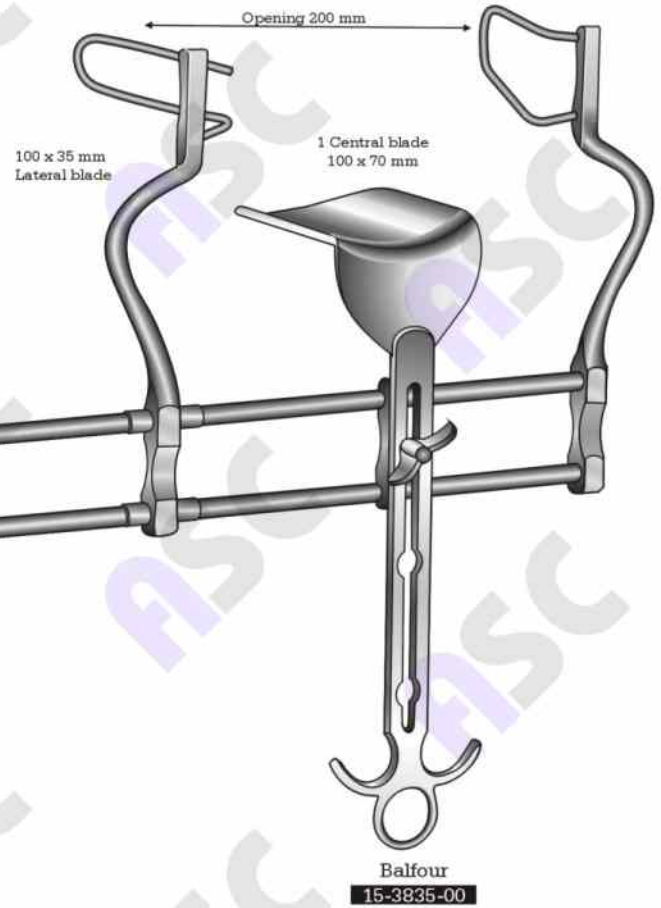
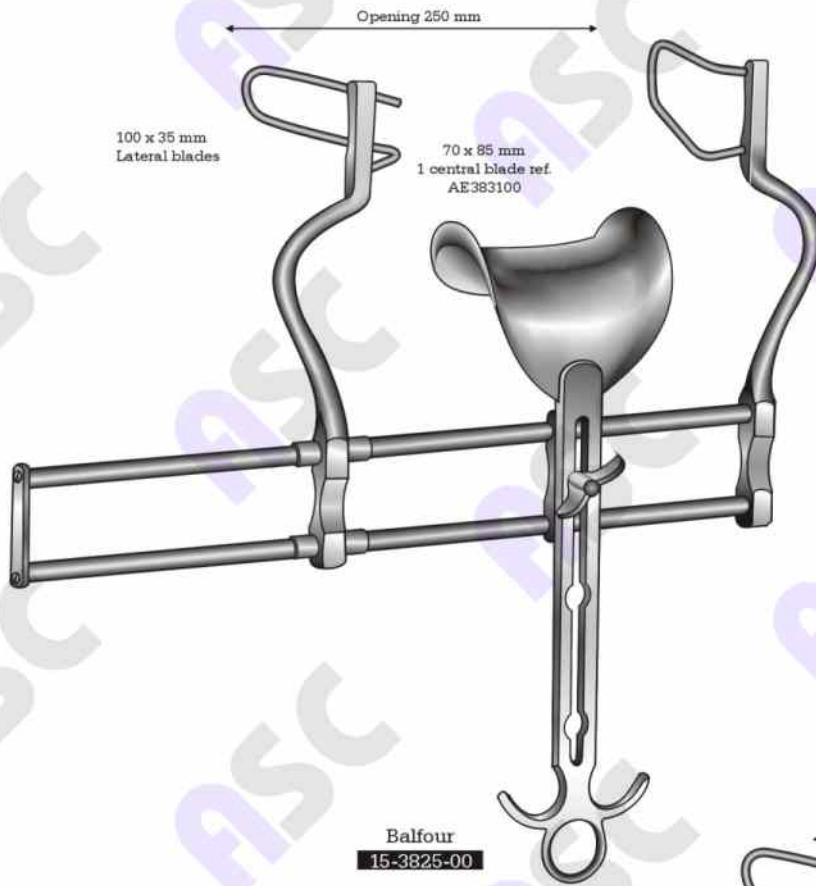

Abdominal Retractors  
Bauchdeckenhalter  
Separadores abdominales

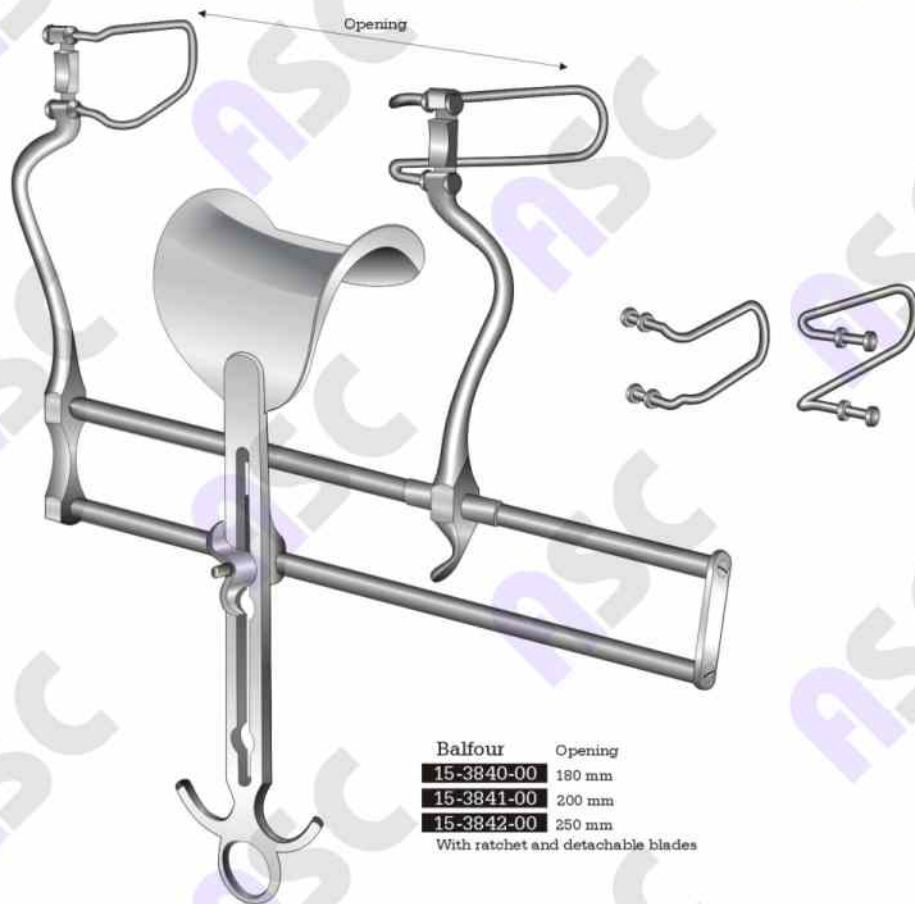

Balfour	Opening
15-3840-00	180 mm
15-3841-00	200 mm
15-3842-00	250 mm

With ratchet and detachable blades

Measurements of blades: Depth x Width



15-3845-00  
70 x 100 mm



15-3850-00 75 x 45 mm  
15-3851-00 65 x 45 mm  
15-3852-00 82 x 70 mm



15-3855-00  
50 x 127 mm

Abdominal Retractors  
Bauchdeckenhalter  
Separadores abdominales

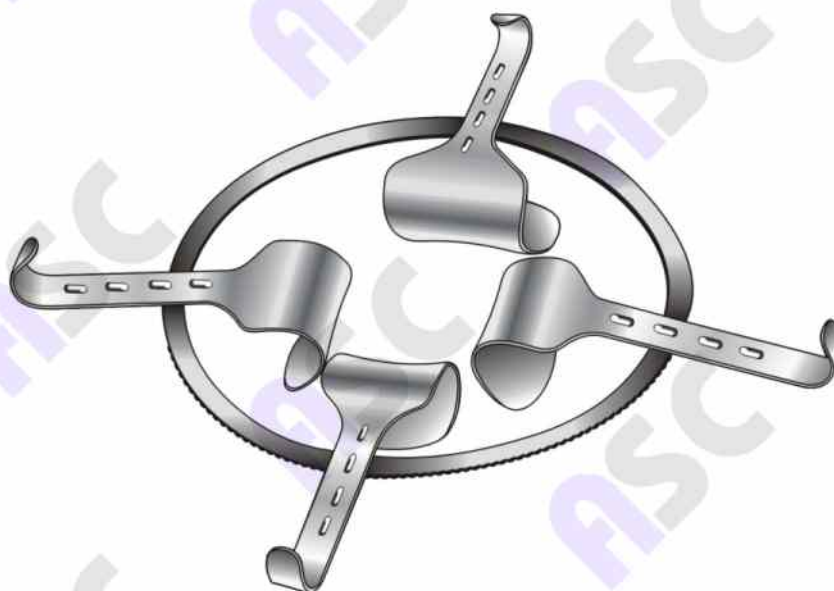

**Kirschner**  
Standard, oval  
**15-3860-00**

Frame only 300 x 240 mm

**Kirschner**  
Standard, oval  
**15-3861-00**

Complete set, consisting 1 frame & 4 blades  
1 frame, 300 x 240 mm  
1 blade, 50 x 65 mm  
1 blade, 80 x 90 mm  
1 blade, 98 x 50 mm  
1 blade, 105 x 35 mm

**Kirschner**  
Standard, oval  
**15-3862-00**

Complete set, consisting 1 frame & 7 blades  
1 frame, 300 x 240 mm  
1 blade, 40 x 55 mm  
1 blade, 50 x 65 mm  
1 blade, 60 x 85 mm  
1 blade, 78 x 65 mm  
1 blade, 80 x 90 mm  
1 blade, 98 x 50 mm  
1 blade, 105 x 35 mm

Measurements of blades: Depth x Width



**15-3865-00**  
40 x 55 mm  
Standard



**15-3866-00**  
50 x 65 mm  
Standard



**15-3867-00**  
60 x 85 mm  
Standard

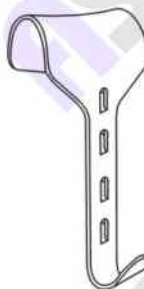

**15-3868-00**  
78 x 65 mm  
For obese patients

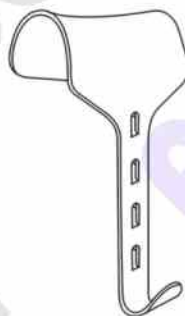

**15-3869-00**  
80 x 90 mm  
For obese patients



**15-3870-00**  
98 x 50 mm  
For intestinal and bladder



**15-3871-00**  
105 x 35 mm  
For intestinal and bladder

Abdominal Retractors for new-born and children

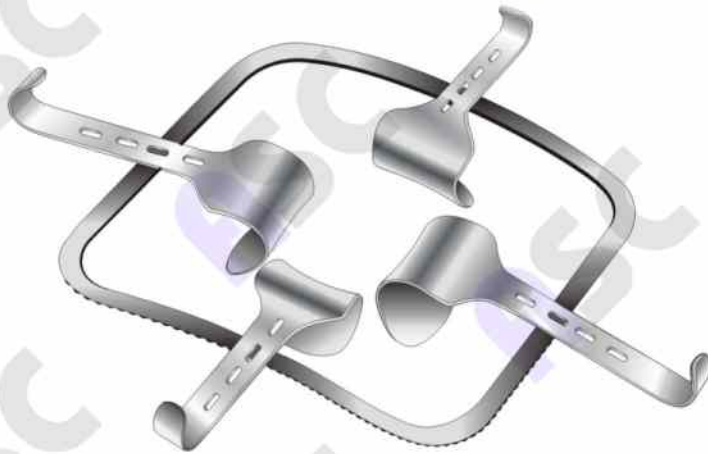

**Kirschner**  
**15-3875-00**  
Complete set, consisting 1 frame & 4 blades  
1 Frame, 240 x 240 mm  
2 blades, 40 x 55 mm  
2 blades, 50 x 65 mm

**Kirschner**  
**15-3876-00**  
Frame only  
240 x 240 mm



**Kirschner**  
**15-3865-00**  
40 x 55 mm

**Kirschner**  
**15-3866-00**  
50 x 65 mm

**15-3880-00**

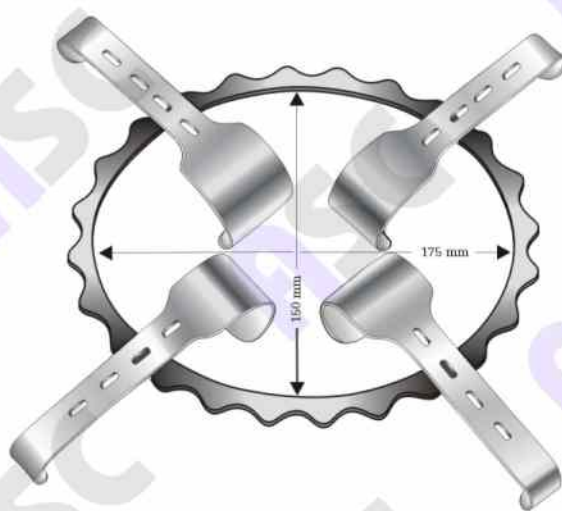

**Denis-Browne**  
**15-3885-00**  
Complete set, consisting 1 frame & 4 blades  
1 Frame, 150 x 175 mm  
2 blades, 20 x 30 mm  
2 blades, 20 x 40 mm

**Denis-Browne**  
**15-3886-00**  
150 x 175 mm  
Frame only



**15-3890-00**  
20 x 30 mm  
Blades only

**15-3891-00**  
20 x 40 mm  
Blades only

Abdominal Retractors  
Bauchdeckenhalter  
Separadores abdominales

Extra blades are available only with set.

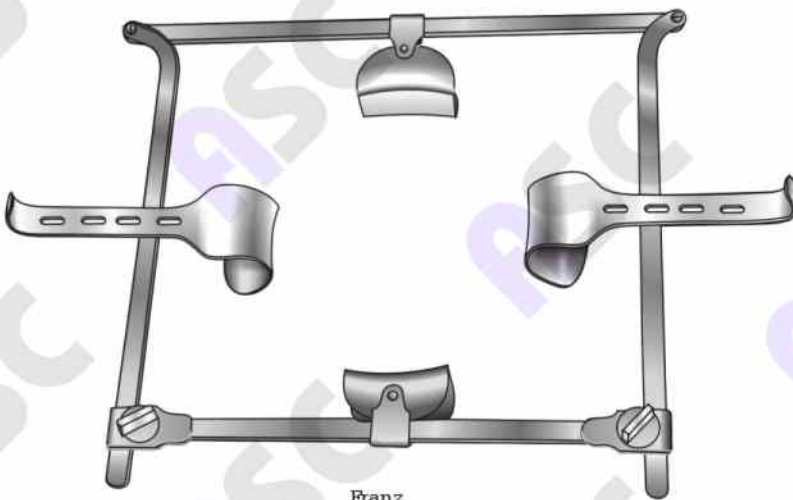

**Franz**

**15-3895-00**

Complete set, consisting 1 frame & 8 blades  
Folding frame, 300 x 300 mm  
2 blades, 50 x 65 mm  
2 blades, 60 x 85 mm  
2 blades, 38 x 60 mm  
2 blades, 45 x 80 mm

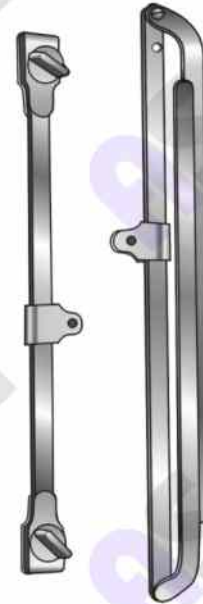

**Franz**

**15-3900-00**

300 x 300 mm  
Frame only  
Folded



**15-3866-00**  
50 x 65 mm

**15-3905-00**  
38 x 60 mm



**15-3867-00**  
60 x 85 mm

**15-3906-00**  
45 x 80 mm

Laminectomy Retractors  
Laminektomiesperrer  
Separadores para laminectomia

See Blades on next Page



Scoville  
**15-3915-00**  
Frame only  
Spreading 150 mm  
**15-3916-00**  
Complete set of 13 pieces (hooks & blades)

Scoville-Haverfield  
**15-3910-00**  
Frame only, with joint  
Spreading 150 mm  
**15-3911-00**  
Complete set of 13 pieces (hooks & blades)

Laminectomy Retractors  
 Laminektomiesperrer  
 Separadores para laminectomia

Blades used with 15-3916-00 & 15-3911-00



Scoville  
**15-3920-00**  
 50 mm deep  
 Blunt



Scoville  
**15-3925-00**  
 70 mm deep  
 Blunt



Scoville  
**15-3930-00**  
 50 mm deep  
 Sharp



Scoville  
**15-3935-00**  
 70 mm deep  
 Sharp



Scoville  
**15-3940-00** 60 x 25 mm  
**15-3941-00** 64 x 50 mm  
**15-3942-00** 88 x 25 mm  
 Toothed



Taylor  
**15-3945-00** 48 x 50 mm  
**15-3946-00** 64 x 50 mm  
**15-3947-00** 64 x 64 mm  
**15-3948-00** 80 x 57 mm  
 Sharp



Scoville  
**15-3950-00** 41 x 38 mm  
**15-3951-00** 67 x 44 mm  
 Sharp



Wound Spreaders  
Wundspreizer  
Separadores autoestáticos



15-3955-16  
40 mm



15-3965-25  
40 mm



15-3956-16  
45 mm



15-3966-25  
45 mm



15-3957-16  
50 mm



15-3967-25  
50 mm



15-3958-16  
55 mm



15-3968-25  
55 mm



15-3959-16  
60 mm



15-3969-25  
60 mm



Cloward  
16 cm / 6 1/4"

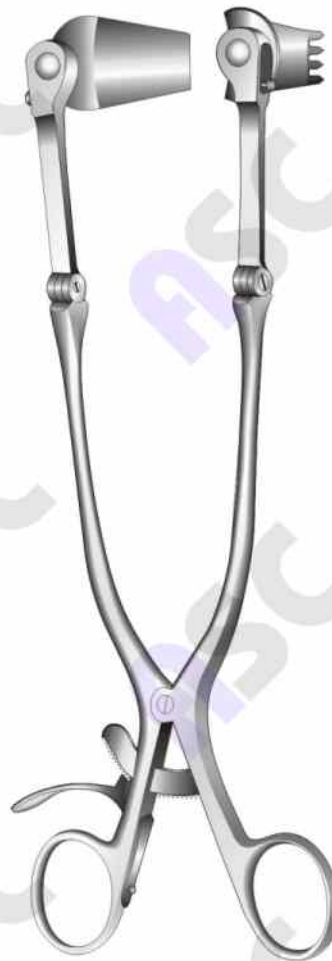

Cloward  
25 cm / 10"

Abdominal Spatula  
Bauchspatel  
Espátulas abdominales



**Tessier**  
**15-4001-22**  
22 cm / 8 3/4"  
10-12 mm  
Conical, black chromium plated



**Tessier**  
**15-4005-22**  
22 cm / 8 3/4"  
15-17 mm  
Conical, black chromium plated



**Tessier**  
**15-4010-22**  
22 cm / 8 3/4"  
20-22 mm  
Conical, black chromium plated



**15-4015-00** 200 x 12 mm  
**15-4016-00** 200 x 17 mm  
**15-4017-00** 250 x 25 mm



**Reverdin**  
**15-4020-29**  
29 cm / 11 1/2"



**Reverdin**  
**15-4025-28**  
28 cm / 11"



**Haberer**  
**15-4030-20** 20 cm / 8", 17/25 mm  
**15-4030-28** 28 cm / 11", 25/30 mm  
**15-4030-30** 30 cm / 12", 37/45 mm  
Flexible



**15-4035-33** 30 mm  
**15-4036-33** 40 mm  
**15-4037-33** 50 mm  
33 cm / 13"

Cotton Applicators, Sponge Holder  
Watteträger, Schwammhalter  
Portas algodones, Portas esponjas



Tobold  
16-2070-25  
25 cm / 10"

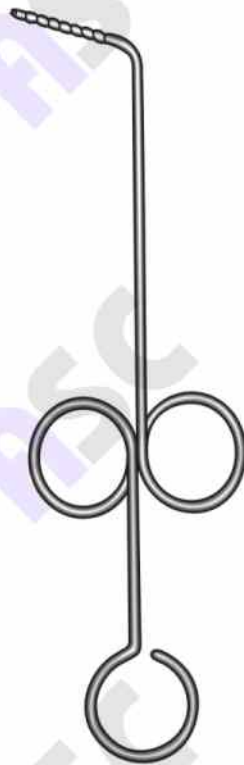

Hartmann  
16-2075-20  
20 cm / 8"



16-3035-37  
37.5 cm / 15"  
16-3035-45  
45 cm / 17 1/2"

Needle Holders  
Nadelhalter  
Portas para agujas

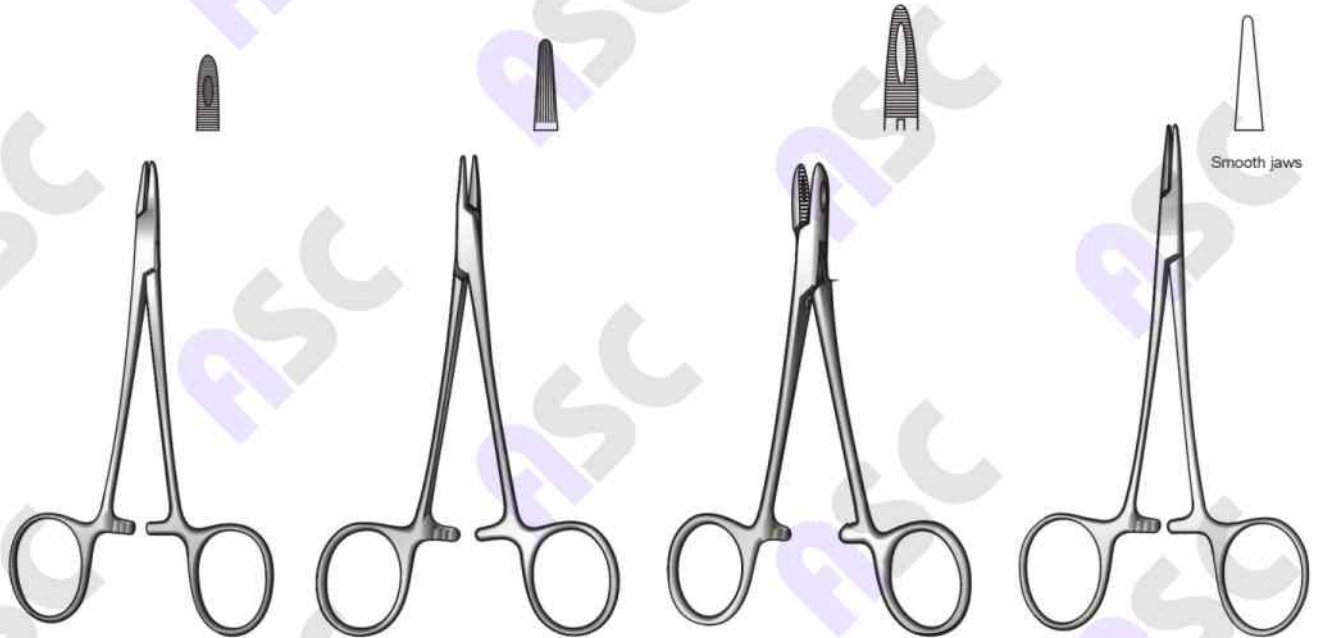

**Derf**  
20-0427-12  
12 cm / 4 1/4"

**Derf**  
20-0429-12  
12.5 cm / 5"

**Collier**  
20-0433-12  
12.5 cm / 5"

**Halsey**  
20-0437-13  
12.5 cm / 5"  
20-0437-11  
11 cm / 4 1/4"  
Delicate



**Webster**  
20-0435-13 Smooth  
20-3001-13 Serrated  
13 cm / 5"  
Delicate

**Neivert**  
20-0439-13  
13 cm / 5"

**Kilner**  
20-0732-13  
13.5 cm / 5 1/4"

**Hegar-Baumgartner**  
20-0441-14  
14 cm / 5 1/2"

Needle Holders  
Nadelhalter  
Portas para agujas



**Bruce-Clarke**  
**20-2010-12**  
12.5 cm / 5"



**Crile-Murray**  
**20-0449-15**  
15 cm / 6"



**Crile-Wood**  
**20-0451-15** 15 cm / 6"  
**20-0451-18** 18 cm / 7"  
**20-0451-20** 20 cm / 8"

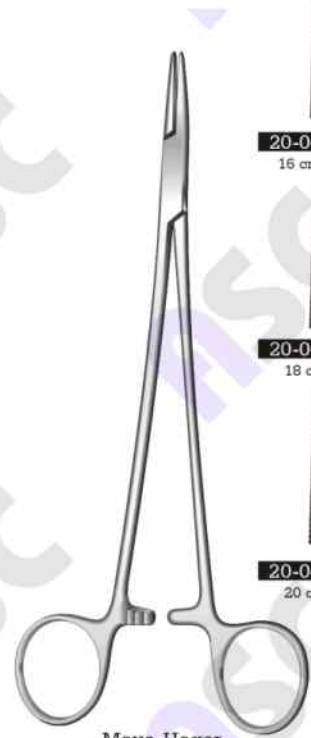

**Mayo-Hegar**  
Delicate

**20-0497-16**  
16 cm / 6 1/4"

**20-0497-18**  
18 cm / 7"

**20-0497-20**  
20 cm / 8"



**Mayo-Hegar**

**20-0491-14** 14 cm / 5 1/2"  
**20-0491-16** 16 cm / 6 1/4"

**20-0491-18** 18 cm / 7"  
**20-0491-20** 20 cm / 8"

**20-0491-24** 24 cm / 9 1/2"  
**20-0491-26** 26 cm / 10 1/4"



**Adson**  
**20-0461-18**  
18 cm / 7"



**Metzenbaum**  
**20-0465-18**  
18 cm / 7"

Needle Holders  
Nadelhalter  
Portas para agujas



**Finocchietto**  
**20-3005-27**  
27 cm / 10½"



**Wangensteen**  
**20-3010-27**  
27 cm / 10½"



**Wangensteen**  
**20-3015-27**  
27 cm / 10½"



**Masson**  
**20-3020-27**  
27 cm / 10½"



**Sarot**  
**20-3025-18** 18 cm / 7"  
**20-3025-26** 26 cm / 10¼"

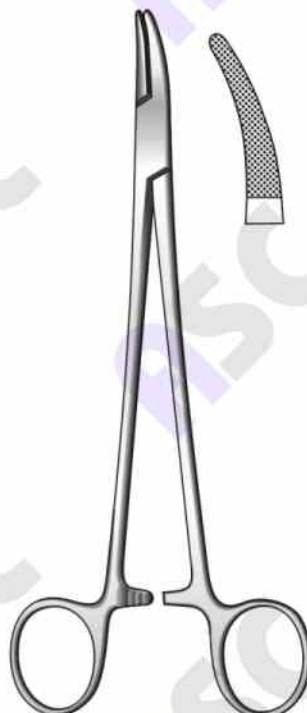

**Heaney**  
**20-3030-21**  
21 cm / 8¼"

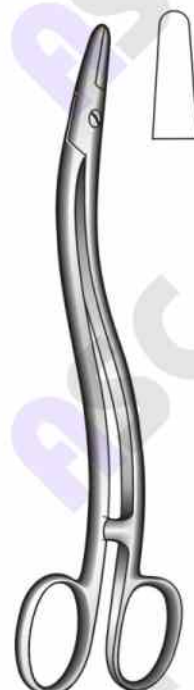

**Thomson-Walker**  
**20-3035-20**  
20 cm / 8"

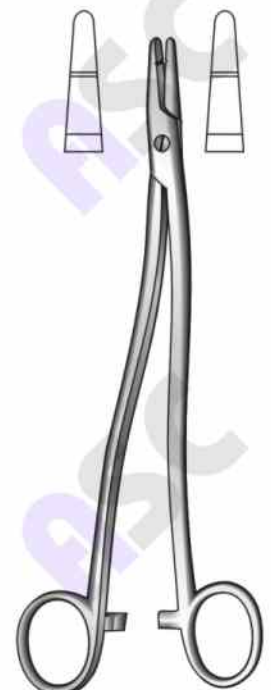

**Bozemann**  
**20-3040-20** 20 cm / 8"  
**20-3040-24** 24 cm / 9½"

Needle Holders  
Nadelhalter  
Portas para agujas



**Johnson**  
20-3045-27  
27 cm / 10½"



**Stratte**  
20-3050-23  
23 cm / 9"



**Olsen-Hegar**  
20-0567-14  
14 cm / 5½"

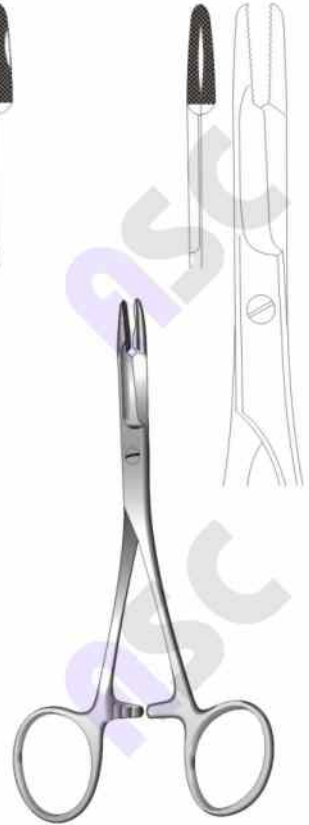

**Olsen-Hegar**  
20-3055-14 14 cm / 5½"  
20-3055-16 16 cm / 6¼"  
20-3055-17 17 cm / 6¾"  
20-3055-19 19 cm / 7½"

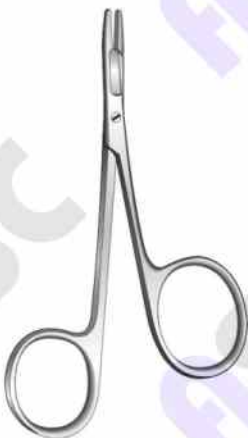

**Mini Gillies**  
20-2026-10  
10 cm / 4"



**Foster Gillies**  
20-2015-12  
12.5 cm / 5"  
Serrated jaws



**Gillies**  
20-0570-16  
16 cm / 6¼"  
Serrated jaws

Needle Holders  
Nadelhalter  
Portas para agujas



**Olsen-Hegar**  
 20-0565-12 12 cm / 4 3/4", Mini  
 20-0565-14 14 cm / 5 1/2"  
 20-0565-16 16 cm / 6 1/4"  
 20-0565-18 18 cm / 7"



**Eiselsberg**  
 20-3060-11  
 11.5 cm / 4 1/4"

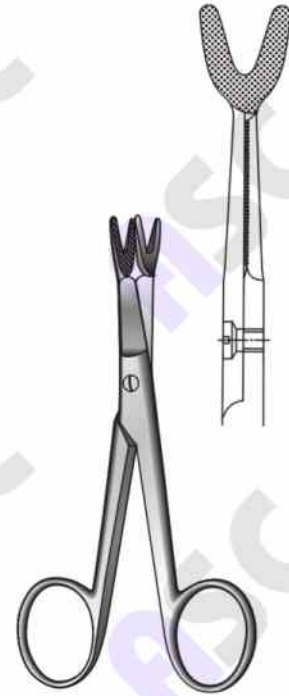

**Schoemaker-Loth**  
 20-3065-12  
 12.5 cm / 5"



**Crile**  
 20-0601-15  
 15 cm / 5"



**MacPhail**  
 (Cooper jaw)  
 20-2030-14 14 cm / 5 1/2"  
 20-2030-16 16 cm / 6 1/4"  
 20-2030-18 18 cm / 7"  
 20-2030-20 20 cm / 8"



Needle Holders  
Nadelhalter  
Portas para agujas



20-0617-14	14 cm / 5½"	20-2035-14
20-0617-16	16 cm / 6¼"	20-2035-16
20-0617-17	17 cm / 6¾"	20-2035-17
20-0617-20	20 cm / 8"	20-2035-20
20-0617-24	24 cm / 9½"	20-2035-24



20-0627-14	14 cm / 5½"	20-0627-17
		17 cm / 6¾"



Mathieu  
Slender jaws



20-0637-17	20-0637-20
17 cm / 6¾"	20 cm / 8"



Mathieu



Lichtenberg  
20-0677-20  
20 cm / 8"

Needle Holders  
Nadelhalter  
Portas para agujas



20-0413-14



20-0414-14



20-2045-14



20-2046-14



20-2050-13	13 cm / 5 1/4"	20-2055-13
20-2050-16	16 cm / 6 1/4"	20-2055-16
20-2050-18	18 cm / 7"	20-2055-18
20-2050-20	20 cm / 8"	20-2055-20
20-2050-23	23 cm / 9"	20-2055-23



20-2051-13	13 cm / 5 1/4"	20-2056-13
20-2051-16	16 cm / 6 1/4"	20-2056-16
20-2051-18	18 cm / 7"	20-2056-18
20-2051-20	20 cm / 8"	20-2056-20
20-2051-23	23 cm / 9"	20-2056-23



20-0407-14



20-0408-14



McPherson  
20-2044-10  
10 cm / 4"

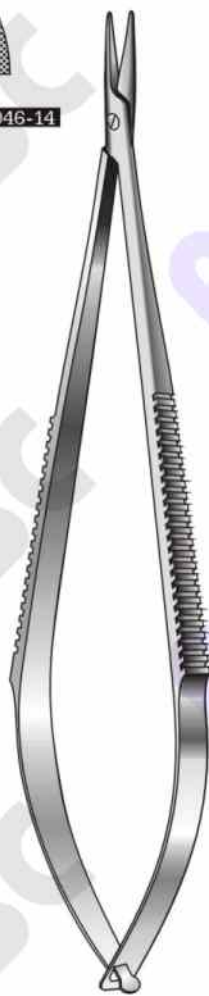

Castroviejo  
13.5 cm / 5 1/2"  
Without lock

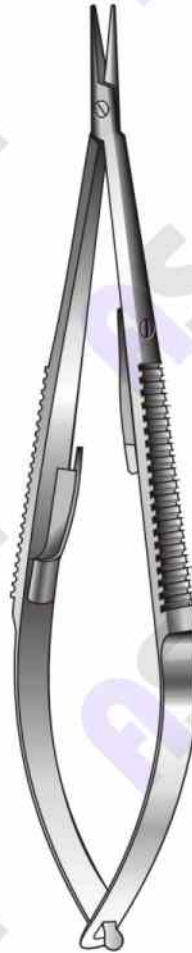

Castroviejo  
With lock



Castroviejo  
13.5 cm / 5 1/2"  
Extra delicate, with lock

	<b>20-0389-13</b> 13 cm / 5¼"	<b>20-3070-13</b>
	<b>20-0389-16</b> 16 cm / 6¼"	<b>20-3070-16</b>
	<b>20-0389-18</b> 18 cm / 7"	<b>20-3070-18</b>
	<b>20-0389-20</b> 20 cm / 8"	<b>20-3070-20</b>
	<b>20-0389-23</b> 23 cm / 9"	<b>20-3070-23</b>
	With lock	With lock
	<b>20-0390-13</b> 13 cm / 5¼"	<b>20-3071-13</b>
	<b>20-0390-16</b> 16 cm / 6¼"	<b>20-3071-16</b>
	<b>20-0390-18</b> 18 cm / 7"	<b>20-3071-18</b>
	<b>20-0390-20</b> 20 cm / 8"	<b>20-3071-20</b>
	<b>20-0390-23</b> 23 cm / 9"	<b>20-3071-23</b>
	Without lock	Without lock

	<b>20-0401-13</b> 13 cm / 5¼"
	<b>20-0401-16</b> 16 cm / 6¼"
	<b>20-0401-18</b> 18 cm / 7"
	<b>20-0401-20</b> 20 cm / 8"
	<b>20-0401-23</b> 23 cm / 9"
	With lock



Barraquer



Barraquer  
**20-3075-13**  
13 cm / 5¼"



Barraquer-Troutman



Arruga  
**20-0391-14** Straight  
**20-2058-14** Curved  
14 cm / 5½"



Stevens  
**20-2060-16**  
16.5 cm / 6½"  
With ratchet lock

Needle Holders  
Nadelhalter  
Portas para agujas



**Kalt**  
**20-0375-14**  
13 cm / 5¼"  
Standard model  
Delicate jaws



**20-0415-16**      **20-0416-16**

**Arruga**  
16 cm / 6¼"



**Boynton**  
**20-2065-12**  
12.5 cm / 5"  
Delicate

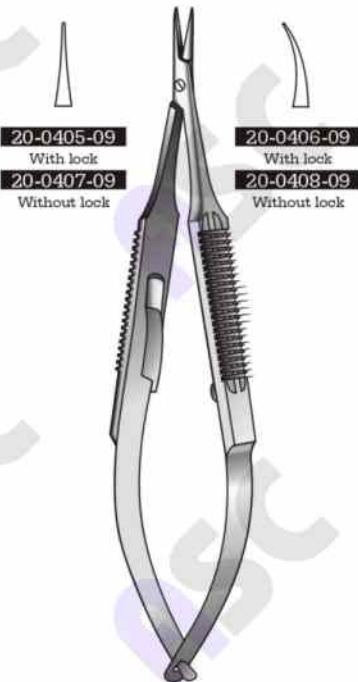

**20-0405-09**      **20-0406-09**  
With lock      With lock  
**20-0407-09**      **20-0408-09**  
Without lock      Without lock

**Castroviejo**  
9 cm / 3½"



**Castroviejo**  
**20-0417-12**  
12 cm / 4¾"



**Castroviejo Barraquer**  
**20-0418-12**  
12 cm / 4¾"



**Castroviejo**  
**20-0417-13**  
13 cm / 5"



0.4  
Mini profile  
Mini profil  
Profil mini

**Derf**  
**20-0733-12T**  
12 cm / 4 1/4"



Serrated

Smooth  
glett  
Lisas

**Webster**  
**20-0738-12T**  
**20-2070-12T**  
12 cm / 4 1/4"



Serrated

Smooth  
glett  
Lisas

**Webster**  
**20-0731-13T**  
**20-2075-13T**  
12 cm / 4 1/4"  
Delicate

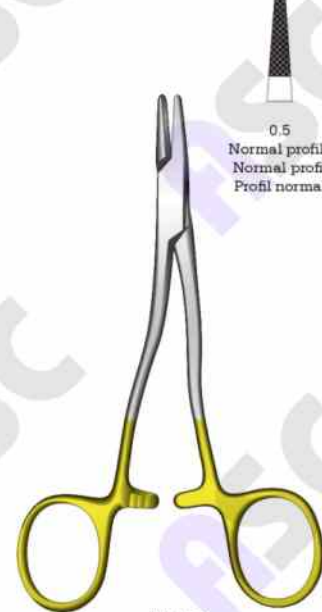

0.5  
Normal profile  
Normal profil  
Profil normal

**Kilner**  
**20-0732-13T**  
13.5 cm / 5 1/4"



**20-0737-13T**  
Plain  
Smooth  
Glett  
Lisas



0.4  
**20-0738-13T**  
Serrated  
Mini profile  
Mini profil  
Profil mini

**Halsey**  
13 cm / 5"



0.5  
**20-0735-13T** 13 cm / 5"  
**20-0735-14T** 14 cm / 5 1/2"



Normal profile  
Normal profil  
Profil normal

**Hegar-Baumgartner**



0.4  
**20-0705-13T** 13 cm / 5"  
**20-0705-15T** 15 cm / 6"

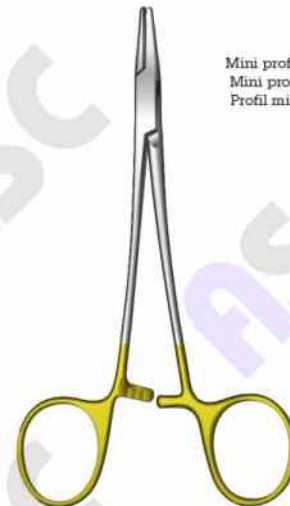

Mini profile  
Mini profil  
Profil mini

Needle Holders  
Nadelhalter  
Portas para agujas

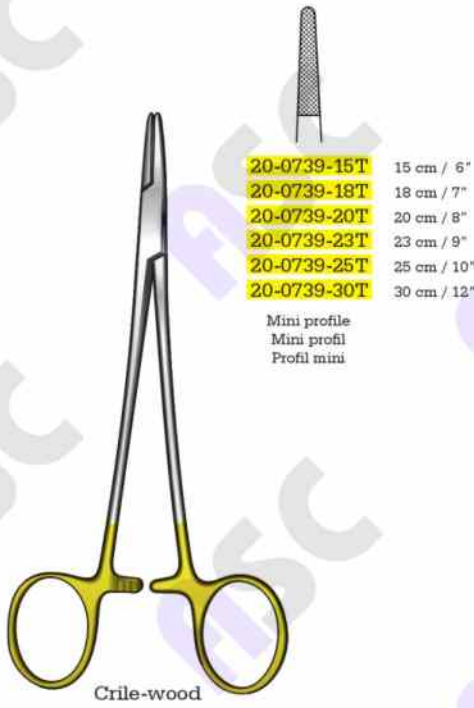









Ryder

		
<b>20-0751-13T</b> 13 cm / 5"	<b>20-0751-15T</b> 15 cm / 6"	<b>20-0751-18T</b> 18 cm / 7"
		
<b>20-0751-20T</b> 20 cm / 8"	<b>20-0751-23T</b> 23 cm / 9"	<b>20-0751-26T</b> 26 cm / 10 1/4"

Mini profile  
Mini profil  
Profil mini



Ryder  
Angled

		
<b>20-3085-13T</b> 13 cm / 5"	<b>20-3085-15T</b> 15 cm / 6"	<b>20-3085-18T</b> 18 cm / 7"
		
<b>20-3085-20T</b> 20 cm / 8"	<b>20-3085-23T</b> 23 cm / 9"	<b>20-3085-26T</b> 26 cm / 10 1/4"

Mini profile  
Mini profil  
Profil mini



Hegar-Vascular

	
<b>20-3090-14T</b> 14 cm / 5 1/2"	<b>20-3090-18T</b> 18 cm / 7"
	
<b>20-3090-20T</b> 20 cm / 8"	<b>20-3090-23T</b> 23 cm / 9"

Micro profile  
Mikro profil  
Profil micro



Ryder-Vascular

		
<b>20-3095-13T</b> 13 cm / 5"	<b>20-3095-15T</b> 15 cm / 6"	<b>20-3095-18T</b> 18 cm / 7"
		
<b>20-3095-20T</b> 20 cm / 8"	<b>20-3095-23T</b> 23 cm / 9"	<b>20-3095-26T</b> 26 cm / 10 1/4"

Micro profile  
Mikro profil  
Profil micro

Needle Holders  
Nadelhalter  
Portas para agujas

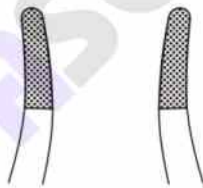

0.5	0.5
<b>20-3100-22T</b>	<b>20-3105-22T</b>
22 cm / 8½"	22 cm / 8½"
Right	Left
<b>20-3100-23T</b>	<b>20-3105-23T</b>
23 cm / 9"	23 cm / 9"
Right	Left

Normal profile  
Normal profil  
Profil normal



Stratte



Bozemann



0.5  
**20-3110-20T**  
20 cm / 8"

Normal profile  
Normal profil  
Profil normal



0.5  
**20-3115-20T**  
20 cm / 8"



0.5  
**20-3115-24T**  
24 cm / 9½"



0.5  
**20-3115-26T**  
26 cm / 10¼"

Normal profile  
Normal profil  
Profil normal



Heaney





0.5  
Normal profile  
Normal profil  
Profil normal



0.5  
Normal profile  
Normal profil  
Profil normal



0.5  
Normal profile  
Normal profil  
Profil normal



**Masson**  
**20-3120-27T**  
27 cm / 10½"



**Wangenstein**  
**20-3125-27T**  
27 cm / 10½"

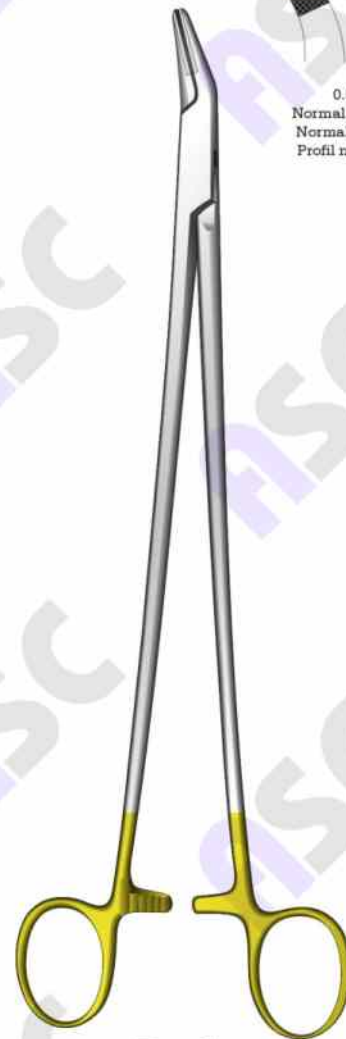

**Finocchio**  
**20-3130-27T**  
27 cm / 10½"

Needle Holders  
Nadelhalter  
Portas para agujas



**Sarot**

0.5  
Normal profile  
Normal profil  
Profil normal

- 20-3135-18T 18 cm / 7"
- 20-3135-20T 20 cm / 8"
- 20-3135-26T 26 cm / 10 1/4"

**Thomson Walker**

0.5  
Normal profile  
Normal profil  
Profil normal

- 20-3140-20T 20 cm / 8"

**Naunton Morgan**

0.5  
Normal profile  
Normal profil  
Profil normal

- 20-3145-26T 26 cm / 10 1/4"

**Olsen-Hegar**

0.5  
Normal profile  
Normal profil  
Profil normal

- 20-3150-14T 14 cm / 5 1/2"
- 20-3150-16T 16 cm / 6 1/4"
- 20-3150-17T 17 cm / 6 3/4"
- 20-3150-19T 19 cm / 7 1/2"

**Olsen-Hegar**

0.2  
Micro profile  
Micro profil  
Profil micro

- 20-3155-12T 12 cm / 4 1/2"

**Forester Gillies**

0.4  
Mini profile  
Mini profil  
Profil mini

- 20-0773-14T 14 cm / 5 1/2"
- 20-0773-16T 16 cm / 6 1/4"
- 20-0773-17T 17 cm / 6 3/4"
- 20-0773-19T 19 cm / 7 1/2"

- 20-3160-12T 12.5 cm / 5"  
Serrated jaws

**Gillies**

0.4  
Mini profile

- 20-0774-16T 16 cm / 6 1/4"

**Mini Gillies**  
Special model

- 20-0774-15T 12 cm / 4 1/2"  
Mini profile
- 20-3165-10T 10 cm / 4"  
Micro profile



Mathieu



Mini profile  
Mini profil  
Profil mini



Mathieu - Standard



Normal profile  
Normal profil  
Profil normal



Mathieu



Mini profile  
Mini profil  
Profil mini



Lichtenberg  
**20-0787-20T**  
20 cm / 8"



Tbennis  
**20-0785-18T**  
18 cm / 7"  
Elastic pattern











Langenbeck



Needle Holders  
Nadelhalter  
Portas para agujas



			
<b>20-3175-13T</b>	<b>20-0721-13T</b> 13 cm / 5¼"	<b>20-0722-13T</b>	
	<b>20-0721-14T</b> 14 cm / 5½"	<b>20-0722-14T</b>	
	<b>20-0721-16T</b> 16 cm / 6¼"	<b>20-0722-16T</b>	
	<b>20-0721-18T</b> 18 cm / 7"	<b>20-0722-18T</b>	
	<b>20-0721-20T</b> 20 cm / 8"	<b>20-0722-20T</b>	
	<b>20-0721-21T</b> 21 cm / 8½"	<b>20-0722-21T</b>	
	<b>20-0721-23T</b> 23 cm / 9"	<b>20-0722-23T</b>	
	Smooth	Smooth, curved	
			
<b>20-3176-13T</b>	<b>20-2100-13T</b> 13 cm / 5¼"	<b>20-2105-13T</b>	<b>20-3180-13T</b>
	<b>20-2100-14T</b> 14 cm / 5½"	<b>20-2105-14T</b>	
	<b>20-2100-16T</b> 16 cm / 6¼"	<b>20-2105-16T</b>	
	<b>20-2100-18T</b> 18 cm / 7"	<b>20-2105-18T</b>	
	<b>20-2100-20T</b> 20 cm / 8"	<b>20-2105-20T</b>	
	<b>20-2100-21T</b> 21 cm / 8½"	<b>20-2105-21T</b>	
	<b>20-2100-23T</b> 23 cm / 9"	<b>20-2105-23T</b>	
	Micro profile	Micro profile	
			
<b>20-3177-13T</b>			<b>20-3181-13T</b>



**McPherson**  
**20-3170-10T**  
10 cm / 4"

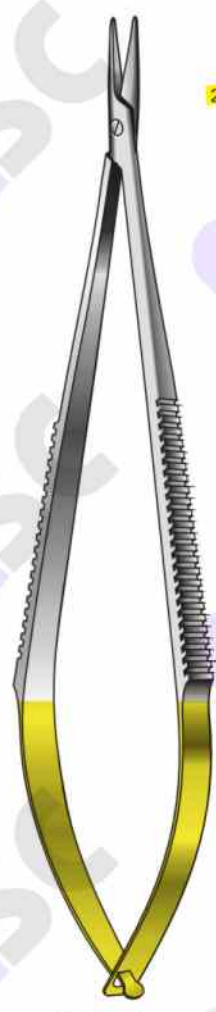

**Castroviejo**  
13.5 cm / 5½"  
Without lock





**Castroviejo**  
With lock



**Castroviejo**  
13.5 cm / 5½"  
Extra delicate, with lock



			
<b>20-3185-13T</b>	13 cm / 5¼"	<b>20-3190-13T</b>	
<b>20-3185-16T</b>	16 cm / 6¼"	<b>20-3190-16T</b>	
<b>20-3185-18T</b>	18 cm / 7"	<b>20-3190-18T</b>	
<b>20-3185-20T</b>	20 cm / 8"	<b>20-3190-20T</b>	
<b>20-3185-23T</b>	23 cm / 9"	<b>20-3190-23T</b>	
With lock		With lock	
<b>20-3186-13T</b>	13 cm / 5¼"	<b>20-3191-13T</b>	
<b>20-3186-16T</b>	16 cm / 6¼"	<b>20-3191-16T</b>	
<b>20-3186-18T</b>	18 cm / 7"	<b>20-3191-18T</b>	
<b>20-3186-20T</b>	20 cm / 8"	<b>20-3191-20T</b>	
<b>20-3186-23T</b>	23 cm / 9"	<b>20-3191-23T</b>	
Without lock		Without lock	

	
<b>20-3205-13T</b>	13 cm / 5¼"
<b>20-3205-16T</b>	16 cm / 6¼"
<b>20-3205-18T</b>	18 cm / 7"
<b>20-3205-20T</b>	20 cm / 8"
<b>20-3205-23T</b>	23 cm / 9"
With lock	



Barraquer

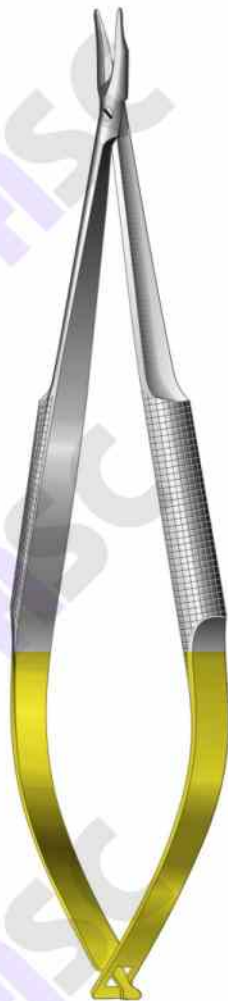

Barraquer  
**20-3200-13T**  
13 cm / 5¼"



Barraquer-Troutman



Arruga  
**20-3211-14T** Straight  
**20-3210-14T** Curved  
14 cm / 5½"

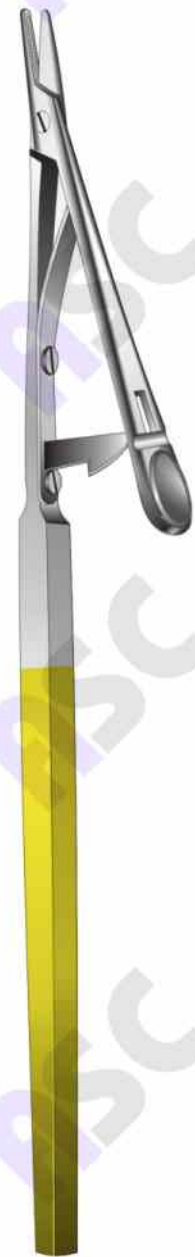

Stevens  
**20-3215-16T**  
16.5 cm / 6½"  
With ratchet lock

Needle Holders  
Nadelhalter  
Portas para agujas



**Kalt**  
**20-2115-13T**  
13 cm / 5¼"  
Standard model  
Delicate jaws



**20-0723-16T**      **20-0724-16T**

**Arruga**  
18 cm / 6¾"



**Boynton**  
**20-2110-12T**  
12.5 cm / 5"  
Delicate



**20-3220-09T**  
With lock  
**20-3221-09T**  
Without lock

**20-3225-09T**  
With lock  
**20-3226-09T**  
Without lock

**Castroviejo**  
9 cm / 3½"



**Castroviejo**  
**20-3230-12T**  
12 cm / 4¾"



**Castroviejo Barraquer**  
**20-3235-12T**  
12 cm / 4¾"



**Castroviejo**  
**20-3240-13T**  
13 cm / 5"

Reverdin Needles  
Reverdin-Nadeln  
Agujas de reverdin



Reverdin  
14 cm / 5 1/2"  
Short



20-0802-15  
Fig. 1



20-0803-15  
Fig. 2



20-0804-15  
Fig. 3



20-0805-15  
Fig. 4



Reverdin



20-0822-19  
20-0842-23  
Fig. 1



20-0823-19  
20-0843-23  
Fig. 2



20-0824-19  
20-0844-23  
Fig. 3



20-0825-19  
20-0845-23  
Fig. 4

19.5 cm / 7 1/4"  
23 cm / 9"

Reverdin Needles  
Reverdin-Nadeln  
Agujas de reverdin

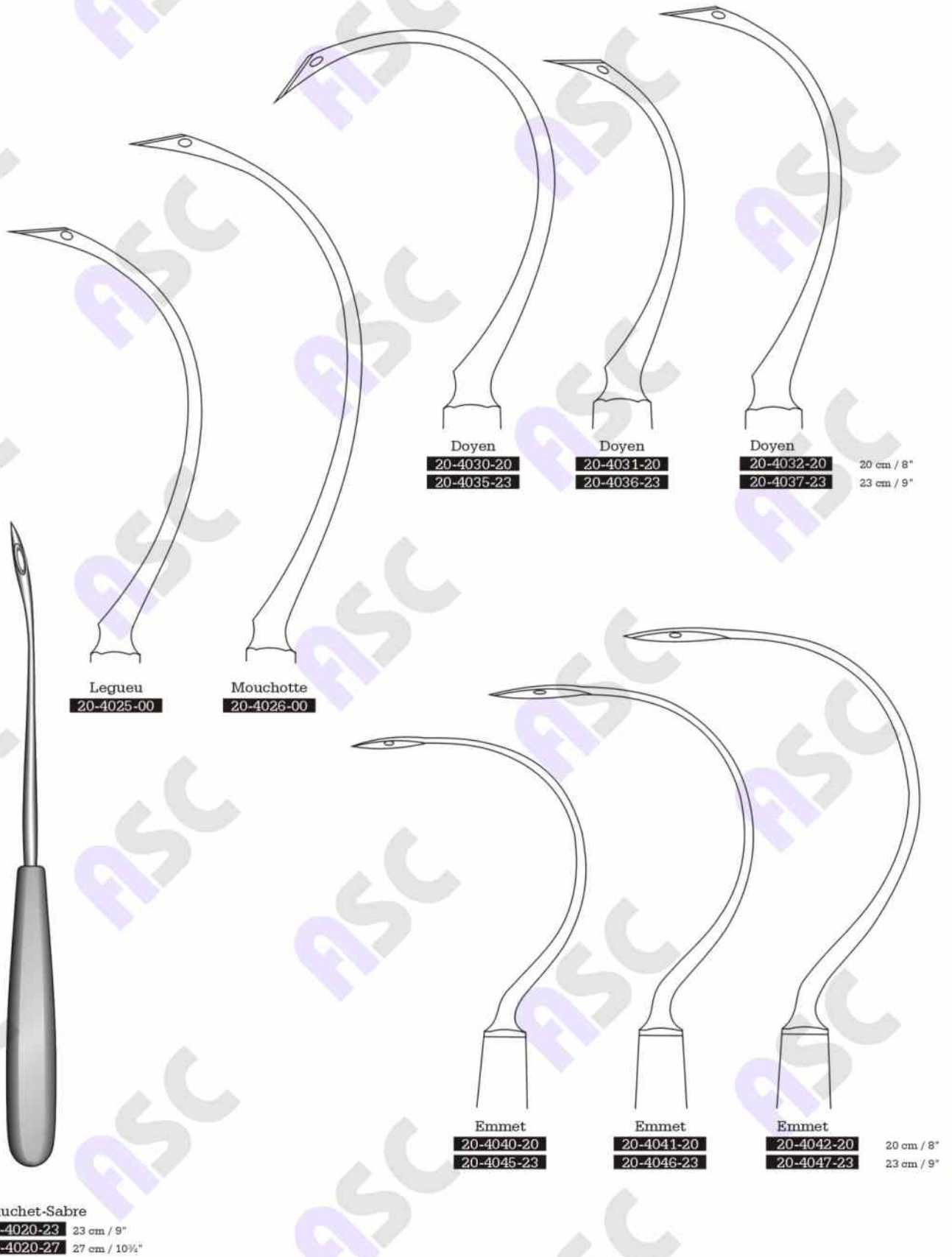



Reverdin Needles  
Reverdin-Nadeln  
Agujas de reverdin



20-4125-00  
Fig. 1



20-4126-00  
Fig. 2

20-4127-00  
Fig. 3



Young-Hryntschank  
20-4120-24  
24 cm / 9½"  
Complete with one needle no. 1



Young-Millin  
20-4130-20  
20 cm / 8"  
With 1 needle

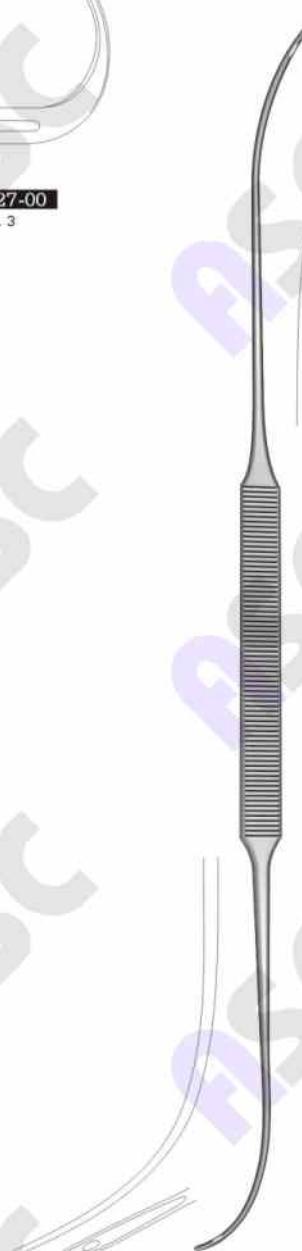

Schmieden-Dick  
20-4135-30  
30 cm / 12"

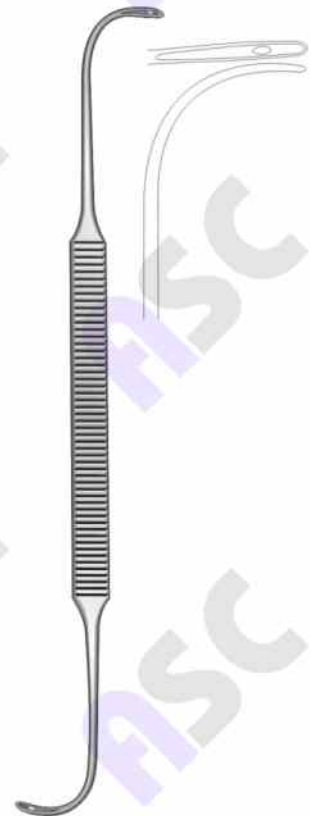

Schmieden  
20-4140-24  
24 cm / 9½"

Ligature Needles  
Unterbindungsnadeln  
Agujas para ligaduras

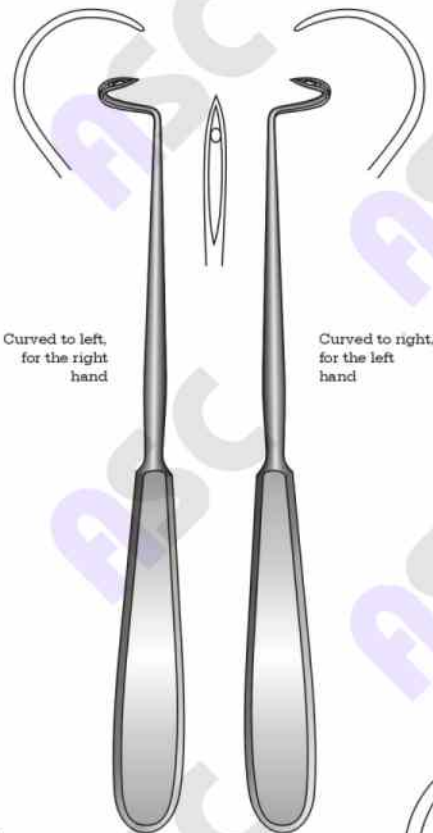

Curved to left,  
for the right  
hand

Curved to right,  
for the left  
hand

**Deschamps**  
**20-4150-20**  
**20-4151-20**  
20 cm / 8"  
Sharp

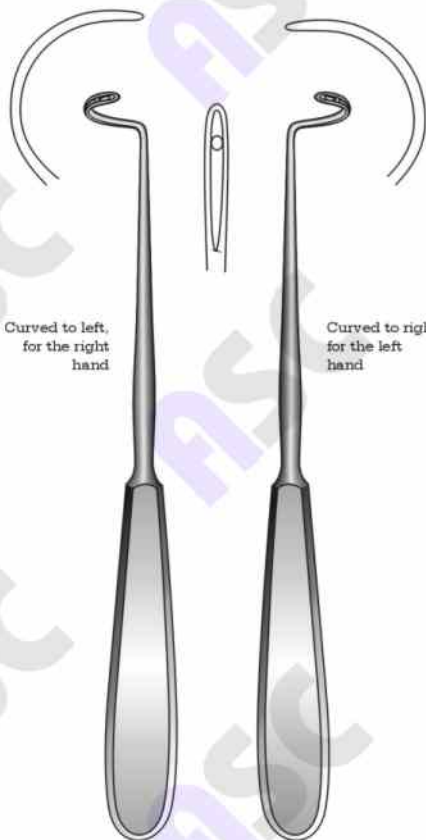

Curved to left,  
for the right  
hand

Curved to right,  
for the left  
hand

**Deschamps**  
**20-4145-20**  
**20-4146-20**  
20 cm / 8"  
Blunt

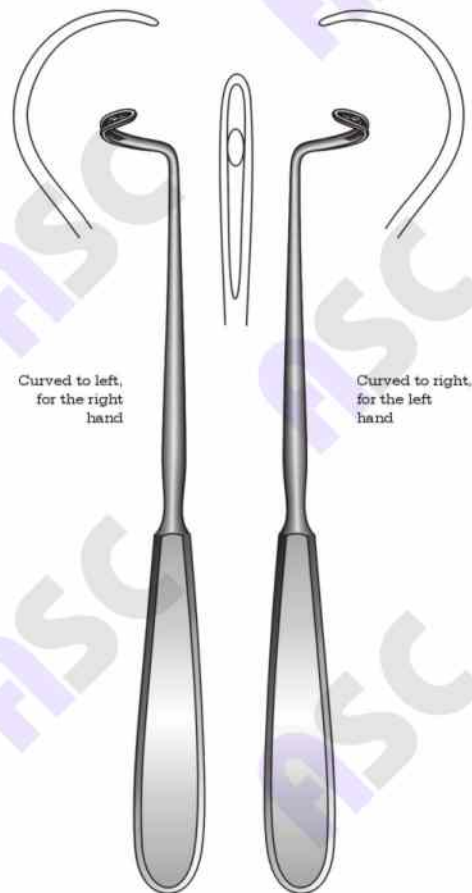

Curved to left,  
for the right  
hand

Curved to right,  
for the left  
hand

**Deschamps**  
**20-4155-21**  
**20-4156-21**  
21 cm / 8 1/4"  
Blunt

Ligature Needles  
Unterbindungsnadeln  
Agujas para ligaduras

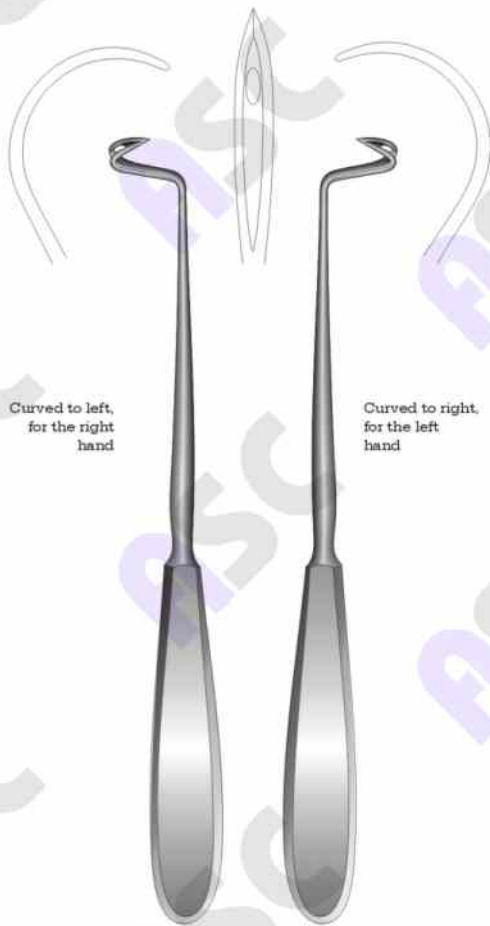

Curved to left,  
for the right  
hand

Curved to right,  
for the left  
hand

**Deschamps**  
**20-4160-21**  
**20-4161-21**  
21 cm / 8¼"  
Sharp



Curved to left,  
for the right  
hand

Curved to right,  
for the left  
hand

**Deschamps**  
**20-4165-27**  
**20-4166-27**  
27 cm / 10½"  
Blunt

Ligature Needles  
Unterbindungsnadeln  
Agujas para ligaduras

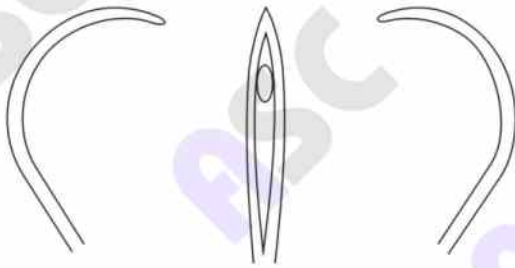

Curved to left,  
for the right  
hand

Curved to right,  
for the left  
hand



Deschamps  
20-4170-27  
20-4171-27  
27 cm / 10 1/2"  
Sharp

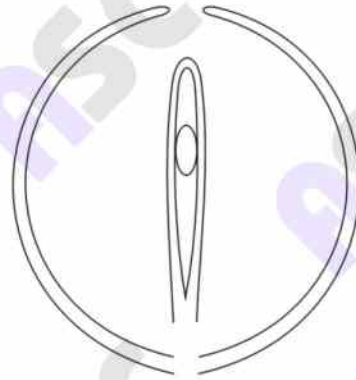

Curved to left,  
for the right  
hand

Curved to right,  
for the left  
hand



Deschamps  
20-4175-28  
20-4176-28  
28 cm / 11"  
Blunt

Ligature Needles  
Unterbindungsnadeln  
Agujas para ligaduras

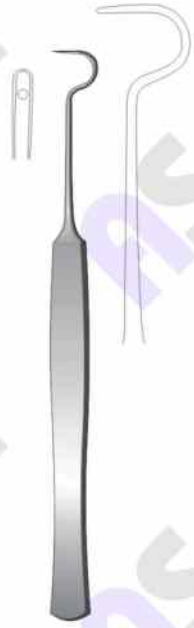

**20-4180-15**  
15 cm / 6"

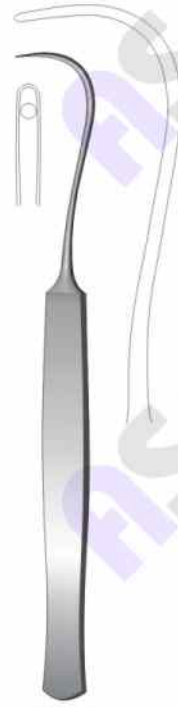

Syme  
**20-4185-17**  
17 cm / 6¾"

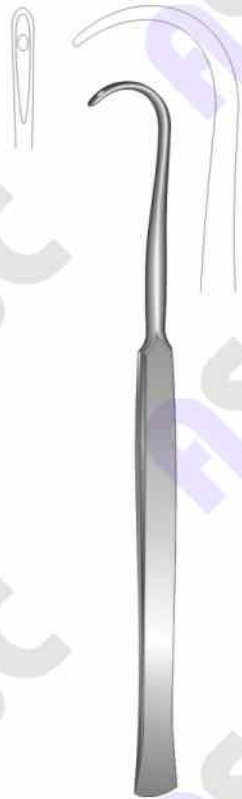

Cooper  
**20-4190-19**  
19 cm / 7½"



Cooper  
**20-4195-20**  
20.5 cm / 8"

Ligature Needles  
Unterbindungsnadeln  
Agujas para ligaduras



**Kocher**  
20-4200-20  
20.5 cm / 8"



**Malleable**  
20-4205-23  
23 cm / 9"

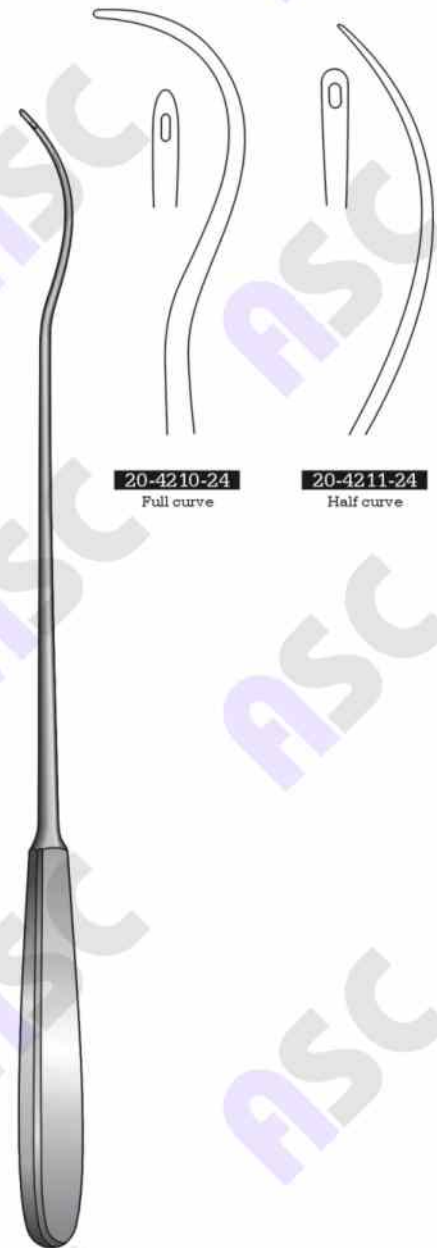

**Brunner**  
24 cm / 9½"



3 mm

**20-4215-20**  
20 cm / 8"



4.5 mm

**Koenig**  
**20-4220-19**  
19.5 cm / 7 1/2"



7 mm

**Koenig**  
**20-4225-20**  
20 cm / 8"



8 mm

**Schmieden**  
**20-4230-18**  
18.5 cm / 7 1/4"



11 mm

**Kocher**  
**20-4235-15**  
15 cm / 6"



12 mm



**Kocher**  
**20-4240-17**  
17 cm / 6 1/2"



5 mm

**Payr**  
**20-4245-19**  
19.5 cm / 7 1/2"



5 mm

**Payr**  
**20-4250-22**  
22.5 cm / 9"

Guiding Probes  
Führungssonden  
Sondas para guía



**20-4255-28**  
28 cm / 11"



**Kirschner**  
**20-4260-25**  
25.5 cm / 10"



**Brunner**  
**20-4265-24**  
24.5 cm / 9 1/2"



**20-4270-24**  
24 cm / 9 1/2"



Ligature Conductors, Knot Tiers, Ligature Catcher  
Führungshohlsonden, Fadenknoter, Fänger  
Sondas conductores, Tuerce hilos



Mod. Wiener  
**20-4275-23**  
23.5 cm / 9 1/4"  
Suture hook



**20-4280-23**  
23 cm / 9"  
Ligature catcher



Caspar  
**20-4285-23**  
23 cm / 9"  
Ligature adjuster



## Alphabetical Index



# Alphabetical Index

Abdominal Retractors	155, 157-164
Abdominal Spatula	168
ADSON Artery Forceps	81
ADSON Dissecting Forceps	68
ADSON Dressing and Tissue Forceps	58
ADSON Needle Holders	171
ADSON Suction Tubes	10
ADSON Wound Spreaders	149-151
ADSON-ANDERSON Wound Spreaders	150
ADSON-BABY / CONE Handheld Retractors	148
ADSON-BABY Wound Spreaders	149
ADSON-BECKMANN Wound Spreaders	151
ADSON-BROWN Dissecting Forceps	68
ADSON-BROWN Micro Forceps, Splinter Forceps	63
ADSON-CONE Handheld Retractors	148
ADSON-MICRO Dissecting Forceps	68
ADSON-MICRO Micro Forceps	63
ADSON-TOENNEIS Scissors	29, 49
ALLEN Forceps	113
ALLEN-BABY Forceps	113
ALLIS Forceps	112, 113
ALLIS-ADAIR Forceps	112
ALLIS-ATRAUMA Forceps	111
ALLIS-BABY Forceps	112
ALLIS-JUDD Tissue Holding Forceps	112
ALLIS-LOCKWOOD Tissue Forceps	112
ALLIS-THOMS Tissue Holding Forceps	112
ALM Wound Spreaders	145
Anastomosis Clamp Forceps	120
Anastomosis Forceps, Atrauma	116, 117
ANDERSON-ADSON Wound Spreaders	150
Angiotribe	84
Antrum Puncture Trocar	8
Antrum Trocar	8
Applicators, Cotton	169
ARRUGA Needle Holders	177, 178, 187, 188
Artery Forceps	71-103
Atrauma DOYEN Clamps Forceps	115
Atrauma Intestinal Clamp Forceps	115, 117
Atrauma KOCHER Clamps Forceps	115
Atrauma-MAYO-ROBSON Clamp Forceps	115
Atrauma Sigmoid Anastomosis Forceps	116, 117
Atrauma Stomach Clamp Forceps	115
BABCOCK Forceps	110, 113
BABCOCK-ATRAUMA Tissue Holding Forceps	111
BABINSKI Percussion Hammers	4
BABY-ADSON Handheld Retractors	148
BABY-ALLEN Forceps	113
BABY-BALFOUR Abdominal Retractors	158
BABY-COLLIN Abdominal Retractors	155
BABY-DOYEN Intestinal Clamp Forceps	114
BABY-GOSSET Abdominal Retractors	158
BABY-LEXER Dissecting Scissors, Fino-Line	25
BABY-MIKULICZ Clamp Forceps	96
BABY-MIXTER Forceps	89
BABY-PAYR Intestinal Clamp Forceps	119
BABY-ROUX Retractors	121
BACKHAUS Towel Forceps	102
BADGLEY Retractors	156
BAINBRIDGE Artery Forceps	81
BALFOUR Abdominal Retractors	159, 160
BALFOUR-BABY Abdominal Retractors	158
BALLENTINE Hysterectomy Forceps	99
BALLENTINE-HEANEY Hysterectomy Forceps	99
BALL-SOCKET Towel Forceps	103
Bandage Scissors	45
BARON Suction Tubes	11
BARRAQUER Cilia Forceps	66
BARRAQUER Needle Holders	177, 187
BARRAQUER-CASTROVIEJO Needle Holders	178, 188
BARRAQUER-TROUTMAN Needle Holders	177, 187
BAUMGARTNER-HEGAR Needle Holders	170, 179

BECKMANN Wound Spreaders	151, 152
BECKMANN-ADSON Wound Spreaders	151
BECKMANN-EATON Wound Spreaders	152
BEEBEE-CROWN Fine Operating Scissors	39
BEER Cilia Forceps	66
BENGOLEA Artery Forceps	81
BERGMANN Bandage Scissors	45
BERLINER Percussion Hammers	3
BERNHARD Towel Forceps	103
BERTILLON Calipers	1
BERTRAM-PEER'S Towel Forceps	103
Bile Duct Clamps	91
BILLROTH Trocars	7
BIRKETT Artery Forceps	77
Blade Holders and Breakers	17
BOETTCHER Scissors	30
BONNEY Dissecting Forceps	67
BONNEY Forceps	62
BOYNTON Needle Holders	178, 188
BOZEMANN Dressing Forceps	108
BOZEMANN Needle Holders	172, 182
BOZEMANN-DOUGLAS Dressing Forceps	108
BRAUN-STADLER Scissors	31
Breakers, Razor Blade	17
BROPHY Forceps	60
BROWN-ADSON Forceps	63
BROWNE-DENIS Abdominal Retractors	163
BROWNE-DENIS Forceps	110
BRUCE-CLARKE Needle Holders	171
BRUNNER Atrauma Clamps Forceps	117
BRUNNER Guiding Probes	198
BRUNNER Ligature Needles	196
BRUNS Bandage Scissors	45
Brush, Spare	3, 4
BRYANT Dressing Forceps	105
BUCK Percussion Hammers	3
BUCKLEY Retractors	145
BUELAU Trocars	7
BUIE Forceps	84
Bulldog Clamps	71
BUSCH Scissors	31
CAIRNS Artery Forceps	77
Calipers	1, 2
CAMPBELL Trocars	7
Cannula, Trocar	8
CANNY RYOLL Retractors	122
CARMALT-ROCHESTER Artery Forceps	81
CARMALT-WALTER Splinter Forceps	64
CARREL Artery Forceps	73
CASPAR Ligature Adjuster	199
CASTROVIEJO Calipers	2
CASTROVIEJO Needle Holders	176, 178, 186, 188
CASTROVIEJO Razor Blade Holders (and Breakers)	17
CASTROVIEJO-BARRAQUER Needle Holders	178, 188
CASTROVIEJO-EPKER Calipers	2
Catcher, Ligature	199
Catheter Forceps	5
Catheter Introducing Forceps	5
CHAPUT Forceps	82
CHERON Dressing Forceps	108
CHILD Forceps	110
CHRISTOPHE Artery Forceps	76
Cilia Forceps	66
Clamp Forceps, Anastomosis	120
Clamp Forceps, Atrauma Intestinal	115, 117
Clamp Forceps, Atrauma Stomach	115
Clamp Forceps, Hysterectomy	97-101
Clamp Forceps, Intestinal	113-115, 117, 119, 120
Clamp Forceps, Kidney Pedicle	93, 94
Clamp Forceps, Peritoneal	96
Clamp Forceps, Stomach	118
Clamp Forceps, Vaginal	97-101

## Alphabetical Index

Clamps, Bile Duct	91	DIXON-LOVELACE Artery Forceps	80
Clamps, Bulldog	71	DOUGLAS Cilia Forceps	66
Clamps, Gall Duct	95, 96	DOUGLAS Trocars	8
Clamps, Intestinal	119	DOUGLAS-BOZEMANN Dressing Forceps	108
Clamps, Pylorus	119	DOYEN Abdominal Retractors	157
Clamps, Tubing	104	DOYEN Atrauma Clamp Forceps	115
CLARKE-BRUCE Needle Holders	171	DOYEN Intestinal Clamp Forceps	114
CLOWARD Wound Spreaders	147	DOYEN Retractors	139
COAKLEY Trocars	8	DOYEN Reverdin Needles	190
COEUR Forceps	83	DOYEN Scissors	22
COLLIER Needle Holders	170	DOYEN Towel Forceps	103
COLLIN Abdominal Retractors	155	DOYEN-BABY Intestinal Clamp Forceps	114
COLLIN Dressing Forceps	107	Dressing Forceps	56-70, 105-108
COLLIN Forceps	82, 83	Duct Clamps, Bile	91
COLLIN Retractors	121	DUEHRSEN Forceps	61
COLLIN Scalpel Handles	15	DUKE Trocars	6
COLLIN-BABY Abdominal Retractors	155	DUNHILL Artery Forceps	76
COLLIN-DUVAL Forceps	62	DURANTE Forceps	62
Conductors, Ligature	199	DUVAL Forceps	62, 111, 113
CONE Handheld Retractors	148	DUVAL-COLLIN Forceps	62
COOPER Ligature Needles	195	Ear Suction Tube	11
COTTLE Scissors	30	EASTMAN-RICHARDSON Retractors	138
COTTLE Scissors with Tungsten Carbide Inserts	53	EATON-BECKMANN Wound Spreaders	152
Cotton Applicators	169	EISELSBERG Needle Holders	174
Cotton Swab Forceps	105-113	EMMET Reverdin Needles	190
Cotton Swab Holding Forceps	105	ENGLISH Forceps	56
CRAFOORD Forceps	86	ENGLISH MODEL Towel Forceps	102
CRAFOORD Scissors	28	ENGLISH, T.O.E Forceps	56
CRAFOORD-SELLORS Forceps	86	Enterotomy Scissors	40
CRILE Artery Forceps	74, 75	Episiotomy Scissors	31
CRILE Needle Holders	174	EPKER-CASTROVIEJO Calipers	2
CRILE Retractors	121	ESMARCH Bandage Scissors	45
CRILE-MURRAY Needle Holders	171	Examination Instruments (Calipers)	1,2
CRILE-RANKIN Artery Forceps	74, 75	Face-Lift Scissors	54, 55, 37, 38
CRILE-WOOD Needle Holders	171, 180	FARABEUF Retractors	121
CROWN-BEEBEE Fine Operating Scissors	39	FAURE Clamp Forceps	97
CUSHING Artery Forceps	77	FAVALORO Scissors	27
CUSHING Dissecting Forceps	69	FEHLAND Atrauma Sigmoid Anastomosis Forceps	116
CUSHING Dressing Forceps	59	FELCHENFELD Splinter Forceps	63
CUSHING Hooklets	129	FERGUSSON Forceps	84
CUSHING Retractors	134	FERRIS-SMITH Forceps	62, 67
CUSHING-TAYLOR Dissecting Forceps	69	FERRIS-SMITH Tissue and Grasping Forceps	62
CZERNY Retractors	122	Fine Ligature Scissors	34, 36, 39
DANDY Artery Forceps	76	Fine Operating Gum Scissors	36, 39
DANDY Neurosurgical Scissors	29	Fine Operating Scissors	32-35
DANNES Forceps	113	Fine Operating Scissors (Ribbon Type)	35
DARLING Retractors	154	FINOCCHIETTO Forceps	92
DARTIGUES Retractors	142	FINOCCHIETTO Needle Holders	172, 183
DAVIDSON Retractors	142	FINO-METZENBAUM Scissors	25, 48, 49
DAVIS-RAGNELL Hooklets	130	FINSEN Wound Spreaders	145
De BAKEY Dissecting Forceps	69	FLEURANT Trocars	7
De BAKEY Needle Holders	180	FLEXIBLE Abdominal Spatula	168
De BAKEY Scissors	27	FOERSTER Sponge Forceps	109
De BAKEY Thorax and Vascular Scissors	26	FOMON Scissors	30, 53
DEAN Scissors	30, 51	Forceps, Anastomosis Clamp	120
DEAN-SHALLCROSS Gall Duct Clamps	95	Forceps, Artery	72-81, 85, 93
DEAVER Operating Scissors	20	Forceps, Atrauma Intestinal Clamp	115, 117
DEAVER Retractors	124-126	Forceps, Atrauma Sigmoid Anastomosis	116, 117
DEJERINE Percussion Hammers	3	Forceps, Atrauma Stomach Clamp	115
DEMARTEL-WOLFSON Clamp Forceps	120	Forceps, Catheter	5
DENIS-BROWNE Abdominal Retractors	163	Forceps, Catheter Introducing	5
DERF Needle Holders	170, 179	Forceps, Cilia	66
DESCHAMPS Ligature Needles	192-194	Forceps, Cotton Swab Holding	105-107
DESJARDINS Clamp Forceps	96	Forceps, Dissecting	23-25, 67-70, 85-92
DESMARRES Saddle Hooks	129	Forceps, Dressing	56-61, 105-108
DICK Clamp Forceps	101	Forceps, Foreign Body	107
DICK-SCHMIEDEN Reverdin Needles	191	Forceps, Grasping	61
DIEFFENBACH Bulldog Clamps	71	Forceps, Haemostatic	92
DIETRICH Scissors	26	Forceps, Hysterectomy Clamp	97-101
DISSECTING Fine Operating Scissors	33	Forceps, Intestinal Clamp	113-115, 117, 119, 120
Dissecting Forceps	23-25, 67-70, 85-92	Forceps, Jeweller Type	65
Dissecting Scissors, Fino-Line	25	Forceps, Kidney Pedicle Clamp	93, 94

Forceps, Ligature	85-92
Forceps, Micro	63
Forceps, Organ Grasping	61, 62, 82-84
Forceps, Peritoneal Clamp	96
Forceps, Sigmoid Anastomosis	116, 117
Forceps, Sinus	105
Forceps, Splinter	63, 64
Forceps, Sponge	108, 109
Forceps, STANDARD	56, 68
Forceps, Stomach Clamp	118
Forceps, T	60
Forceps, Tissue	56-61
Forceps, Tissue Grasping	62, 82-84, 110-113
Forceps, Tissue Holding	110-113
Forceps, Towel	102, 103
Forceps, Vaginal Clamp	97-101
Forceps, Polypus	106, 107
Foreign Body Forceps	107
FORESTER GILLIES Needle Holders	173, 184
FOX-GOLDMAN Scissors	36, 50
FRANZ Abdominal Retractors	164
FRAZIER Retractors	156
FRAZIER Suction Tubes	10
FREEMAN Face-Lift Scissors	38, 55
FREEMAN-KAYE Face-Lift Scissors	38, 55
FRITSCH Retractors	139
Gall Duct Clamps	95, 96
GARLAND Hysterectomy Forceps	99
GEISSENDOERFER-OVERHOLT Artery Forceps	85
GELPI Retractors	153
General Instruments	168-169
GERALD Dissecting Forceps	67
GERALD Dressing Forceps	60
GILLIES Dissecting Forceps	67
GILLIES Dressing Forceps	58
GILLIES FOSTER Needle Holder	173, 184
GILLIES Needle Holders	173, 184
GILLIES-Mini Needle Holder	173, 184
GIL-VERNET Hooklets	130
GIMINI Dissecting Forceps	87
GOLET Retractors	123
GOLDMAN-FOX Scissors	36, 50
Goniometer	1
GORNEY Face-Lift Scissors	38, 55
GOSSET Abdominal Retractors	158
GOSSET-BABY Abdominal Retractors	158
GRADLE Cilia Forceps	66
GRADLE-STEVENS Fine Operating Scissors	35
GRAEFE Skin Hooks	128
Grasping Forceps	61, 62, 82, 84
GRAY Gall Duct Clamps	95
GRAZIL Operating Scissors	20
GREEN-LANGENBECK Saddle Hooks	129
GREEN-SENN Hooklets	130
GREGOIRE Tissue Forceps	83
GREGORY Face-Lift Scissors	37, 54
GREY-TURNER Artery Forceps	77
GROSS-MAIER Dressing Forceps	105, 106
GRUENWALD Dissecting Forceps	70
Guide Needles	12
Guiding Probes	197, 198
GUNNAR Tubing Clamps	104
GUTHRIE Skin Hooks	128
GUYON Artery Forceps	93
GUYON-MAYO Kidney Pedicle Clamp Forceps	94
Gynecological Scissors	21, 22
HABERER Abdominal Spatula	168
Haemostatic Forceps	92
HALSEY Needle Holders	170, 179
HALSTED-MOSQUITO Artery Forceps	72
Hammers, Percussion	3, 4
Handheld Retractors	148

Handles, Scalpel	13-16
HARRINGTON Retractors	126
HARRINGTON-MAYO Operating Scissors	21
HARRINGTON-MAYO Scissors	52
HARTMANN Cotton Applicators	169
HARVEY Fine Operating Scissors	36
HARVEY JACKSON Wound Spreaders	149
HAVERFIELD-SCOVILLE Laminectomy Retractors	165
HEANEY Clamp Forceps	99, 100
HEANEY Needle Holders	172, 182
HEANEY Retractors	140
HEANEY-BALLENTINE Hysterectomy Forceps	99
HEATH-STITCH Fine Operating Scissors	34
HEGAR-BAUMGARTNER Needle Holders	170, 179
HEGAR-MAYO Needle Holders	171, 180
HEGAR-OSLEN Needle Holders	184
HEGAR-VASCULAR Needle Holders	181
HEISS Artery Forceps	80
HEMI Laminectomy Retractor	150
HENRY Cilia Forceps	66
HERRICK Kidney Pedicle Clamp Forceps	94
HEYMANN Tonsil and Nasal Scissors	30
HIBBS Retractors	123
Holders, Needle	170-188
Holders, Razor Blade	17
Holders, Sponge	169
Holding Forceps, Cotton Swab	105
Holding Forceps, Tissue Organ	110-113
HOLZBACH Abdominal Retractors	155
Hooklets	127-130
Hooklets, Micro	128
Hooks, Skin	128
HOPFNER Tissue Grasping Forceps	83
HOPKINS-JOHNS Bulldog Clamps	71
HOPKINS-JOHNS Dissecting Forceps	88
HOSPITAL-PROVIDENCE Artery Forceps	73
HOUSE Suction Tubes	11
HRYNTSCHANK-YOUNG Reverdin Needles	191
HUNTER Splinter Forceps	64
Hysterectomy Clamp Forceps	97-101
INCISION Operating Scissors	20
Intestinal Clamp Forceps	114-120
IRIS Fine Operating Scissors	33
IRIS Fine Ribbon Type Operating Scissors	35
IRIS Scissors	33, 35, 50
IRIS Splinter Forceps	63
ISRAEL Retractors	133
JACKOBSON POTTS Micro Scissors	44
JACOBSON-MIXTER Dissecting Forceps	90
JAMISON Calipers	1
JANSEN Wound Spreaders	145
JANSEN-WAGNER Wound Spreaders	145
JAYLE Towel Forceps	103
Jeweller Type Forceps	65
JOHNS-HOPKINS Bulldog Clamps	71
JOHNS-HOPKINS Dissecting Forceps	88
JOHNSON Needle Holders	173
JONES Artery Forceps	78
JONES Towel Forceps	102
JOSEPH Fine Operating Scissors	32
JUDD-ALLIS Tissue Holding Forceps	112
JUDD-MASSON Retractors	156
KALT Needle Holders	178, 188
KAYE Face-Lift Scissors	54
KELLY Artery Forceps	74, 75
KELLY Operating Scissors	22
KELLY Retractors	138, 141
KELLY Scissors	51
KELLY-RANKIN Artery Forceps	74, 75
KEYE Face-Lift Scissors	37
Kidney Pedicle Clamp Forceps	93, 94
KILLNER-RAGNELL Scissors	50

## Alphabetical Index

KILNER Artery Forceps	76	MARTEL Tissue Forceps	84
KILNER Fine Operating Scissors	32, 34	MARTEL-WILLET Tissue Grasping Forceps	84
KILNER Needle Holders	170, 179	MASSON Needle Holders	172, 183
KIRSCHNER Abdominal Retractors	162, 163	MASSON-JUDD Retractors	156
KIRSCHNER Guiding Probes	198	MATHIEU Needle Holders	175, 185
KLINKENBERGH-LOTH Scissors	28	MATHIEU Retractors	122
KNIGHT Nasal Scissors	30, 53	MATHIEU-STANDARD Needle Holders	185
Knot Tiers	199	MAYO Clamp Forceps	94
KOCHER Artery Forceps	78	MAYO Operating Scissors	21
KOCHER Atrauma Intestinal Clamp Forceps	115	MAYO Scissors	46
KOCHER Guiding Probes	197	MAYO-ADAMS Retractors	153
KOCHER Ligature Needles	196	MAYO-GUYON Kidney Pedicle Clamp Forceps	94
KOCHER Retractors	132, 135	MAYO-HARRINGTON Operating Scissors	21
KOCHER-ATRAUMA Intestinal Clamp Forceps	115	MAYO-HARRINGTON Scissors	52
KOCHER-LANGENBECK Retractors	136	MAYO-HEGAR Needle Holders	171, 180
KOCHER-NIPPON Artery Forceps	80	MAYO-LEXER Scissors	47
KOENIG Guiding Probes	197	MAYO-NOBLE Operating Scissors	21
KOERTE Retractors	133, 140	MAYO-ROBSON Intestinal Clamp Forceps	114, 115
KONWLES Bandage Scissors	45	MAYO-RUSS Grasping Forceps	61
KRAUSE Trocars	8	MAYO-STILLE Operating Scissors	21, 47
KROENLIEN Artery Forceps	77	Mc INDOE Dissecting Forceps	67
LAHEY Bile Duct Clamps	91	Mc INDOE Thorax Scissors	26
LAHEY-METZENBAUM Scissors	50	Mc INDOE Tissue Forceps	58
Laminectomy Retractors	165, 166	Mc PHERSON Needle Holders	176, 186
LANDAU Trocars	8	Measuring Instruments (Calipers)	1, 2
LANE Dressing Forceps	58	METZENBAUM Dissecting Scissors	23
LANE Stomach Clamp Forceps	118	METZENBAUM Needle Holders	171
LANE Tissue Grasping Forceps	82	METZENBAUM Scissors	47, 48
LANGENBECK Needle Holders	185	METZENBAUM-FINO Dissecting Scissors, Fino-Line	25
LANGENBECK Retractors	134, 135	METZENBAUM-FINO Scissors	25, 48, 49
LANGENBECK-GREEN Saddle Hooks	129	METZENBAUM-LAHEY Scissors	50
LANGENBECK-KOCHER Retractors	136	METZENBAUM-NELSON Dissecting Scissors	24
LANGENBECK-MINI Saddle Hooks	129	METZENBAUM-THOREK Scissors	49
LANGENBECK-PARKER Retractors	122	MEYERDING Hooklets	130
LAWRENCE Dissecting Forceps	88	MEYERDING Retractors	142, 154
LEGUEU Reverdin Needles	190	Micro Forceps	63
LERCHE Dressing Forceps	60	Micro Hooklets	128
LERICHE Artery Forceps	76	Micro Scissors	41-44
LEXER Dissecting Scissors	24	MICRO-ADSON Dissecting Forceps	68
LEXER Scissors	47	MICRO-ADSON Micro Forceps	63
LEXER-BABY Dissecting Scissors, Fino-Line	25	MICRO-MOSQUITO Artery Forceps	72
LEXER-MAYO Scissors	47	MIDDELDORPF Retractors	137
LICHTWITZ Trocars	8	MIKULICZ Peritoneal Clamp Forceps	96
Ligature Catcher	199	MIKULICZ Retractors	141
Ligature Conductors	199	MIKULICZ-BABY Clamp Forceps	96
Ligature Forceps	85-92	MILLER-SENN Hooklets	130
Ligature Needles	192-196	MILLIGAN Wound Spreaders	147
Ligature Scissors	34, 36, 39	MILLIN-YOUNG Reverdin Needles	191
LIGHTENBERG Needle Holders	175, 185	Mini-GILLIES Needle Holder	173, 184
LISTER Bandage Scissors	45	Mini-LANGENBECK Saddle Hooks	129
LISTER Dressing Forceps	105	Mini-ROUX Retractors	121
LITTAUER Cilia Forceps	66	MIXTER Dissecting Forceps	89-91
LITTAUER Fine Operating Scissors	34	MIXTER-BABY Forceps	89
LITTLEWOOD Tissue Holding Forceps	110	MIXTER-JACOBSON Dissecting Forceps	90
LOCKLINE Fine Operating Scissors	39	Mod. WIENER Suture Hook	199
LOCKLINE Scissors	51	Modell. USA Scissors	31
LOCKWOOD Tissue Holding Forceps	110	MOITGEN Calipers	1
LOCKWOOD-ALLIS Tissue Forceps	112	MOLLISON Wound Spreaders	147
LORNA Towel Forceps	102	MORRIS Retractors	136
LOTH-KLINKENBERGH Scissors	28	MOSQUITO Artery Forceps	73
LOTH-SCHOEMAKER Needle Holders	174	MOSQUITO-HALSTED Artery Forceps	72
LOVELACE-DIXON Artery Forceps	80	MOSQUITO-MICRO Artery Forceps	72
LOWER Bile Duct Clamps	91	MOTT-PARKER Retractors	122
MacPHAIL Needle Holders	174	MOUCHOTTE Reverdin Needles	190
MAGILL Catheter Forceps	5	MOYNIHAN Clamp Forceps	98
MAIER Cotton Swab Forceps	107	MURPHY Retractors	132
MAIER-GROSS Dressing Forceps	105, 106	MURRAY-CRILE Needle Holders	171
MAIER-GROSS Forceps	106	Nail Splitting Scissors	40
MAIER-SIMS Cotton Swab Forceps	106	Nasal Scissors	30
MAINGOT Hysterectomy Clamp Forceps	98	NATIONAL HOSPITAL Percussion Hammers	4
MALLEABLE Ligature Needles	196	NAUNTON MORGAN Needle Holders	184
MARCHAC Calipers	1	Needle Holders	170-188

Needle, Spare	3, 4
Needles, Guide	12
Needles, Ligature	192-196
Needles, Reverdin	189-191
NEGUS Artery Forceps	93
NEIVERT Needle Holders	170
NELSON Tissue Forceps	61
NELSON Trocars	6
NELSON-METZENBAUM Dissecting Scissors	24
NEUMANN Fine Ligature Scissors	36
Neurosurgical Scissors	29
NIPPON-KOCHER Artery Forceps	80
NIPPON-PEAN Artery Forceps	80
NOBLE-MAYO Operating Scissors	21
NORFOLK-NORWICH Handheld Retractors	148
NORWICH-NORFOLK Handheld Retractors	148
O'CONNOR-O' SULLIVAN Abdominal Retractors	157
O' SULLIVAN-O' CONNOR Abdominal Retractors	157
O,SHAUGNESSY Dissecting Forceps	91
OCHSNER Trocars	7
O'CONNOR Skin Hooks	128
OEHLER Dissecting Forceps	68
OETTINGEN Abdominal Retractors	155
OLIVE Suction Tubes	10
OLLIER Retractors	137
OLSEN-HEGAR Needle Holders	173, 184
Operating Gum Scissors	36, 39
Operating Scissors	18-22
Operating Scissors, STANDARD	18,19
Organ Grasping Forceps	61, 62, 82, 84
Organ Holding Forceps	110-113
OSLEN-HEGAR Needle Holders	184
OVERHOLT Artery Forceps	85
OVERHOLT-GEISSENDOERFER Artery Forceps	85
PANTINGS Abdominal Retractors	159
PARAMETRIUM Scissors	52
PARKER Retractors	121, 122
PARKER-LANGENBECK Retractors	122
PARKER-MOTT Retractors	122
PAUCHET-SABRE Reverdin Needles	190
PAYR Guiding Probes	198
PAYR Intestinal and Pylorus Clamps	119
PAYR-BABY Intestinal and Pylorus Clamps	119
PEAN Artery Forceps	77,78
PEAN Tissue Forceps	83
PEAN-NIPPON Artery Forceps	80
PEAN-ROCHESTER Artery Forceps	79
Pedicle Clamp Forceps	93
PEERS-BERTRAM Towel Forceps	103
PEET Splinter Forceps	64
PELKMANN Polypus & Dressing Forceps	107
PENNINGTON Tissue Forceps	82
Percussion Hammers	3, 4
Peritoneal Clamp Forceps	96
PERKINS Handheld Retractors	148
PHANEUF Forceps	97
PIERCE Trocars	8
PLESTER Handheld Retractors	148
PLESTER Wound Spreaders	147
Polypus Forceps	106, 107
POOLE Suction Tubes	9
PORRIER Tissue Forceps	82
Postmortem Scissors	40
POTTS DE MARTEL Vascular Scissors	26
POTTS-SMITH Dissecting Forceps	67
POTTS-SMITH Dressing Forceps	59
POTTS-SMITH Scissors	53
PRATT Tissue Forceps	84
Probes, Guiding	197, 198
PROVIDENCE-HOSPITAL Artery Forceps	73
Puncture Trocar, Antrum	8
Pylorus Clamps	119

QUINBY Fine Operating Scissors	36
RABINER Percussion Hammers	4
RAGNELL-DAVIS Hooklets	130
RAGNELL-KILLNER Scissors	50
RALK Splinter Forceps	64
RAMPLEY Sponge Forceps	109
RANKIN-CRILE Artery Forceps	74, 75
RANKIN-KELLY Artery Forceps	74, 75
Razor Blade Breakers	17
Razor Blade Holders	17
REDON Guide Needles	12
RESANO Atrauma Sigmoid Anastomosis Forceps	116
Retractor, Spinal	123
Retractors	121-167
Retractors, Handheld	148
Retractors, Laminectomy	165, 166
REVERDIN Abdominal Spatula	168
REVERDIN Needles	189
REYNOLDS Fine Operating Scissors	32
Ribbon Tenotomy Scissor	35
Ribbon Type Scissors	35
RICARD Retractors	156
RICHARDSON Retractors	138
RICHARDSON-EASTMAN Retractors	138
RIGBY Retractors	153
ROBERTS Dissecting Forceps	87
ROBSON-MAYO Intestinal Clamp Forceps	114, 115
ROCHARD Abdominal Retractors	157
ROCHESTER-CARMALT Artery Forceps	81
ROCHESTER-PEAN Artery Forceps	79
ROEDER Towel Forceps	102
ROUX Retractors	121
ROUX-BABY Retractors	121
ROUX-Mini Retractors	121
Rubber, Spare	3
RUMEL Dissecting Forceps	86
RUSS Modell Grasping Forceps	61
RUSS-MAYO Grasping Forceps	61
RYDER Needle Holders	181
RYDER-VASCULAR Needle Holders	181
SABRE-PAUCHET Reverdin Needles	190
Saddle Hooks	129
SANVENERO Fine Operating Scissors	32
SAROT Dissecting Forceps	86
SAROT Needle Holders	172, 184
SATINSKY Vascular Scissors	28
SAURBRUCH Retractors	139
SAWTELL Haemostatic Forceps	92
Scalpel Handles	13-16
SCHAEDEL Towel Forceps	102
SCHEIBE Tissue Holding Forceps	111
SCHMIEDEN Guiding Probes	197
SCHMIEDEN Reverdin Needles	191
SCHMIEDEN-DICK Reverdin Needles	191
SCHMIEDEN-TAYLOR Neurosurgical Scissors	29
SCHNIDIT Haemostatic Forceps	92
SCHOEMAKER-LOTH Needle Holders	174
SCHUHMACHER Episiotomy and Umbilical Scissors	31
Scissor, Ribbon Tenotomy	35
Scissors with Tungsten Carbide Inserts	46-53
Scissors, Bandage	45
Scissors, Dissecting, Fino-Line	25
Scissors, Enterotomy	40
Scissors, Episiotomy	31
Scissors, Face-Lift	37, 38, 54, 55
Scissors, Fine Ligature	34, 36, 39
Scissors, Fine Operating	32-35
Scissors, Fine Operating (Ribbon Type)	35
Scissors, Fine Operating Gum	36,39
Scissors, Gynecological	21,22
Scissors, Micro	41-44
Scissors, Nail Splitting	40

## Alphabetical Index

Scissors, Nasal	30	Swab Holding Forceps	105
Scissors, Neurosurgical	29	SYME Ligature Needles	195
Scissors, Operating	18-22	SYSTRUNK Nail Splitting Scissors	40
Scissors, Postmortem	40	TAYLOR Dressing and Tissue Forceps	59,60
Scissors, STANDARD	18,19	TAYLOR Laminectomy Retractors	166
Scissors, Suture	34	TAYLOR Percussion Hammers	3
Scissors, Thorax	26-28	TAYLOR Retractors	123
Scissors, Tonsil	30	TAYLOR-CUSHING Dissecting Forceps	69
Scissors, Umbilical	31	TAYLOR-SCHMIEDEN Neurosurgical Scissors	29
Scissors, Vascular	26-28	Tenotomy Scissor, Ribbon	35
SCOVILLE Laminectomy Retractors	165	TERRIER Artery Forceps	73
SCOVILLE-HAVERFIELD Laminectomy Retractors	165	TESSIER Abdominal Spatula	168
SCUDDER Atrauma Intestinal Clamps	117	T-FORCEPS Dressing and Tissue Forceps	60
SELLORS-CRAFORD Forceps	86	THOLE Calipers	1
SEMKEN Dissecting Forceps	69	THOMS-ALLIS Tissue Holding Forceps	112
SEMKEN Dressing and Tissue Forceps	58	THOMSON WALKER Needle Holders	172, 184
SENN-GREEN Hooklets	130	Thorax Scissors	26-28
SENN-MILLER Hooklets	130	THOREK Neurosurgical Scissors	29
SHAAF Splinter Forceps	64	THOREK-METZENBAUM Scissors	49
SHALLCROSS-DEAN Gall Duct Clamps	95	THROKSON Retractors	144
SIEBOLD Operating Scissors	22	Tiers, Knot	199
Sigmoid Anastomosis Forceps	116, 117	Tissue Forceps	56-62, 82-84, 110-113
SIMON Retractors	123	Tissue Grasping Forceps	62, 82-84
SIMS Operating Scissors	22, 52	Tissue Holding Forceps	110-113
SIMS-MAIER Cotton Swab Forceps	106	TOBOLD Cotton Applicators	169
SINGLEY-TUTTLE Grasping Forceps	61	TOENNEIS-ADSON Scissors	29, 49
Sinus Forceps	105	TOENNIS Dissecting and Ligature Forceps	89
Skin Hooks	128	TOENNIS Neurosurgical Scissors	29
SMITH-FERRIS Tissue and Grasping Forceps	62,67	TOHOKU Towel Forceps	103
SMITH-POTTS Dissecting Forceps	67	TONNIS Needle Holders	185
SMITH-POTTS Dressing Forceps	59	Tonsil Scissors	30
SMITH-POTTS Scissors	53	Towel Forceps	102,103
Spare Brush	3, 4	TOWNLEY Calipers	1
Spare Needle	3, 4	TRAUBE Percussion Hammers	3
Spare Rubber	3	TRAVERS Handheld Retractors	148
Spatula	168	TREVES Dressing and Tissue Forceps	56
SPENCER Fine Operating Scissors	34	Trocar Cannula	8
SPENCER-WELLS Artery Forceps	78	Trocar, Antrum Puncture	8
SPIKLE SHEILD Retractors	154	Trocars	6-8
Spinal Retractor	123	TROEMNER Percussion Hammers	3
Splinter Forceps	63, 64	TROUTMAN CHRIS Razor Blade Holders & Breakers	17
Sponge Forceps	108,109	TROUTMAN-BARRAQUER Needle Holders	177,187
Sponge Holder	169	Tube, Ear Suction	11
STADLER-BRAUN Scissors	31	Tubes, Suction	9-11
STANDARD Dissecting Forceps	68	Tubing Clamps	104
STANDARD Dressing and Tissue Forceps	56	TUFFIER Retractors	140
STANDARD NARROW Dressing and Tissue Forceps	56	TUFFIER Tissue Grasping Forceps	82
STANDARD Operating Scissors	18,19	Tungsten Carbide Inserts Scissors	46-53
STANDARD Scalpel Handles	13,14	TURNER-GREY Artery Forceps	77
STANDARD Scissors with Tungsten Carbide Inserts	46	TUTTLE-SINGLEY Grasping Forceps	61
STANDARD Trocars	6	ULRICH Dressing and Cotton Swab Forceps	106
STANDARD Tubing Clamps	104	Umbilical Scissors	31
STELLA-S Face-Lift Scissors	37, 54	UNIT AUDITIVE Suction Tubes	11
STEVEN Fine Operating Scissors	33	UNIVERSAL Fine Operating Scissors	39
STEVENS Needle Holders	177,187	UNIVERSAL Trocars	6
STEVENS-GRADLE Fine Operating Scissors	35	USA Model Dressing and Tissue Forceps	57
STIEGLITZ Splinter Forceps	64	USA Modell Scissors	31
STILLE Dressing and Tissue Forceps	57	USA STANDARD Model Dressing Forceps	57
STILLE Kidney Pedicle Clamp Forceps	94	USA STANDARD Narrow Dressing Forceps	57
STILLE-MAYO Scissors	21, 47	UTILITY Fine Operating Scissors (Ribbon Type)	35
STITCH-HEATH Fine Operating Scissors	34	Vaginal Clamp Forceps	97-101
ST-MARKS Retractors	143	Vascular Scissors	26-28
Stomach Clamp Forceps	115, 118	VASCULAR-HEGAR Needle Holders	181
STONE Dressing and Tissue Forceps	60	VASCULAR-RYDER Needle Holders	181
STRABISMUS Fine Operating Scissors	34	VEIDENHEIMER Atrauma Sigmoid Anastomosis Forceps	116
STRATTE Needle Holders	173	VERNET-GIL Hooklets	130
STRULLY Neurosurgical Scissors	29	VOLKMANN Retractors	131
Suction Tube for Ear	11	WAGNER Fine Operating Scissors	36
Suction Tubes	9-11	WAGNER-JANSEN Wound Spreaders	145
Suture Needles	189-199	WALDMANN Episiotomy and Umbilical Scissors	31
Suture Scissors	34	WALKER THOMSON Needle Holders	172, 184
Swab Forceps, Cotton	106, 107	WALTER-CARMALT Splinter Forceps	64







**Index by Code**

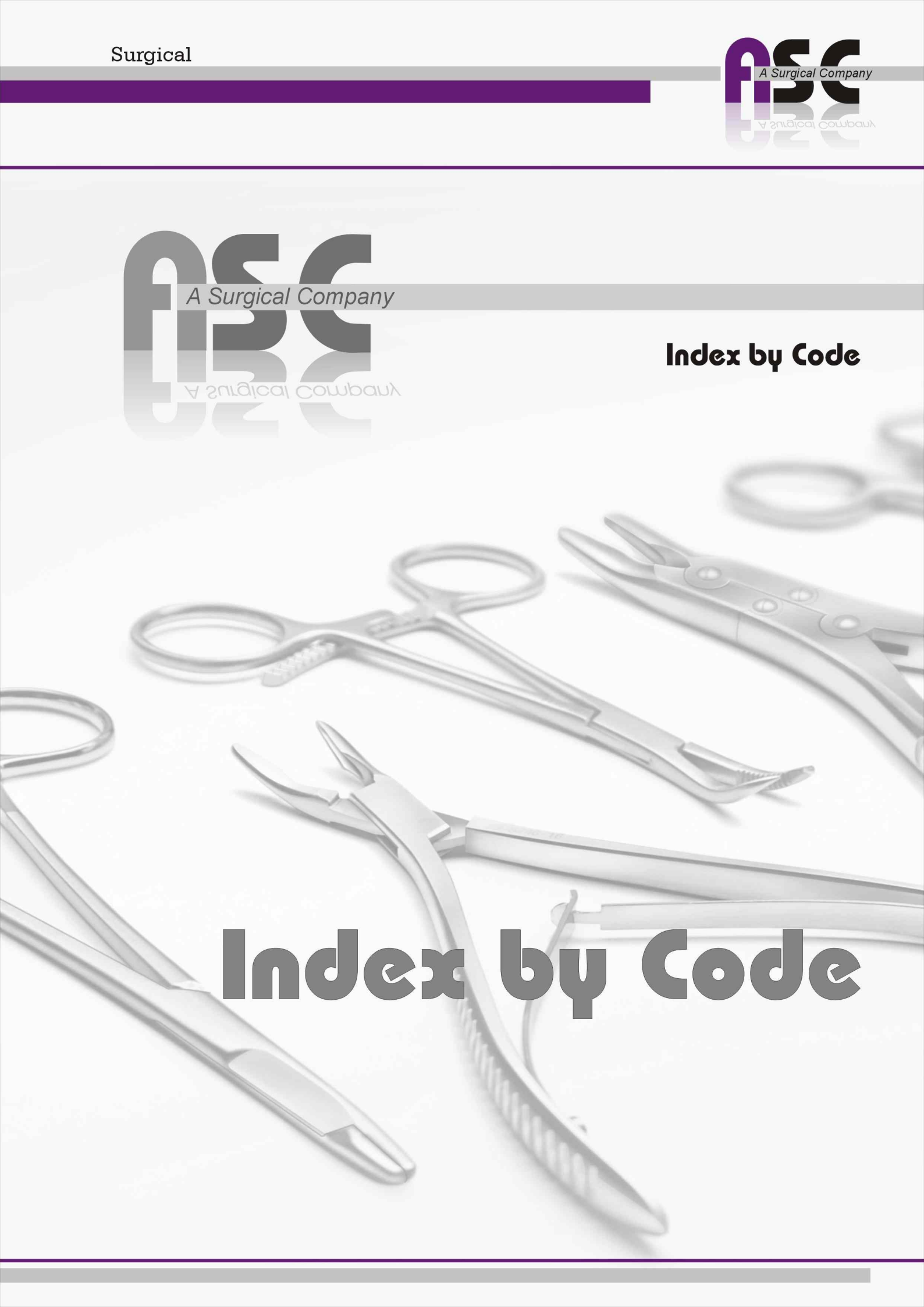

**Index by Code**

Code	Page
10-0201-04	14
10-0205-41	14
10-0205-45	14
10-0213-04	13
10-0231-03	13
10-0231-04	13
10-0231-05	13
10-0234-31	13
10-0234-35	13
10-0238-07	14
10-0238-71	14
10-0241-03	16
10-0243-03	14
10-0247-03	16
10-0248-03	16
10-2001-03	16
10-3001-00	14
10-3005-00	14
10-3010-00	14
10-3015-00	15
10-3020-00	15
10-3025-00	15
10-3030-15	16
10-3035-10	17
10-3040-10	17
10-3045-11	17
10-3050-13	17
11-0201-10	18
11-0201-11	18
11-0201-13	18
11-0201-14	18
11-0201-15	18
11-0201-16	18
11-0201-18	18
11-0201-20	18
11-0203-10	18
11-0203-11	18
11-0203-13	18
11-0203-14	18
11-0203-15	18
11-0203-16	18
11-0203-18	18
11-0203-20	18
11-0205-10	18
11-0205-11	18
11-0205-13	18
11-0205-14	18
11-0205-15	18
11-0205-16	18
11-0205-18	18
11-0205-20	18
11-0206-11	19
11-0206-13	19
11-0206-14	19
11-0206-15	19
11-0206-16	19
11-0206-18	19
11-0206-20	19
11-0208-11	19
11-0208-13	19
11-0208-14	19
11-0208-15	19
11-0208-16	19
11-0208-18	19
11-0208-20	19

Code	Page
11-0210-11	19
11-0210-13	19
11-0210-14	19
11-0210-15	19
11-0210-16	19
11-0210-18	19
11-0210-20	19
11-0271-14	21
11-0271-15	21
11-0271-17	21
11-0271-23	21
11-0272-14	21
11-0272-15	21
11-0272-17	21
11-0272-23	21
11-0327-16	22
11-0327-18	22
11-0328-16	22
11-0328-18	22
11-0349-11	23
11-0350-11	23
11-0351-14	23
11-0353-14	23
11-0355-14	23
11-0356-14	23
11-0358-14	23
11-0360-14	23
11-0365-15	23
11-0366-15	23
11-0427-14	25
11-0427-18	25
11-0427-20	25
11-0427-23	25
11-0428-14	25
11-0428-18	25
11-0428-20	25
11-0428-23	25
11-0429-14	25
11-0429-18	25
11-0429-20	25
11-0429-23	25
11-0430-14	25
11-0430-18	25
11-0430-20	25
11-0430-23	25
11-0441-14	32
11-0442-14	32
11-0451-14	32
11-0452-14	32
11-0596-11	30
11-0598-17	30
11-0667-13	36
11-0668-13	36
11-0671-12	36
11-0672-12	36
11-0695-11	34
11-0696-11	34
11-0706-16	39
11-0708-16	39
11-0731-11	33
11-0732-11	33
11-0734-11	33
11-0736-11	33
11-0874-00	42
11-0874-01	42

Code	Page
11-0874-02	42
11-0925-09	34
11-0927-13	34
11-0935-14	34
11-0963-12	36
11-0966-12	39
11-0971-10	39
11-0972-10	39
11-0975-10	39
11-0976-10	39
11-1055-14T	48
11-1055-18T	48
11-1055-20T	48
11-1055-23T	48
11-1055-25T	48
11-1055-28T	48
11-1055-30T	48
11-1056-14T	48
11-1056-18T	48
11-1056-20T	48
11-1056-23T	48
11-1056-25T	48
11-1056-28T	48
11-1056-30T	48
11-1057-14T	48
11-1057-16T	48
11-1057-18T	48
11-1057-20T	48
11-1057-23T	48
11-1058-14T	48
11-1058-16T	48
11-1058-18T	48
11-1058-20T	48
11-1058-23T	48
11-1068-18T	49
11-1068-20T	49
11-1068-23T	49
11-1069-18T	49
11-1069-20T	49
11-1069-23T	49
11-1070-18T	49
11-1070-20T	49
11-1070-23T	49
11-1071-18T	49
11-1071-20T	49
11-1071-23T	49
11-1081-13T	50
11-1082-13T	50
11-1085-11T	50
11-1086-11T	50
11-1090-11T	50
11-1095-12T	50
11-1100-16T	51
11-1105-16T	51
11-1115-17T	51
11-1120-16T	51
11-1125-16T	51
11-2030-11	33
11-2035-11	33
11-2036-11	33
11-2037-11	33
11-2045-13T	50
11-3030-14	20
11-3031-14	20
11-3035-13	20

Code	Page
11-3035-14	20
11-3040-14	20
11-3041-14	20
11-3042-14	20
11-3045-14	20
11-3046-14	20
11-3047-14	20
11-3050-22	21
11-3050-30	21
11-3055-22	21
11-3055-30	21
11-3060-15	21
11-3060-16	21
11-3060-17	21
11-3060-19	21
11-3060-21	21
11-3065-15	21
11-3065-16	21
11-3065-17	21
11-3065-19	21
11-3065-21	21
11-3070-17	21
11-3071-17	21
11-3075-14	22
11-3075-19	22
11-3075-22	22
11-3080-24	22
11-3085-20	22
11-3085-23	22
11-3090-20	22
11-3090-23	22
11-3095-18	22
11-3096-18	22
11-3100-18	23
11-3100-20	23
11-3100-23	23
11-3100-25	23
11-3100-28	23
11-3100-30	23
11-3105-18	23
11-3105-20	23
11-3105-23	23
11-3105-25	23
11-3105-28	23
11-3105-30	23
11-3110-18	24
11-3110-20	24
11-3110-23	24
11-3110-25	24
11-3110-28	24
11-3110-30	24
11-3115-18	24
11-3115-20	24
11-3115-23	24
11-3115-25	24
11-3115-28	24
11-3115-30	24
11-3120-18	24
11-3120-20	24
11-3120-23	24
11-3120-25	24
11-3120-28	24
11-3120-30	24
11-3125-18	24
11-3125-20	24

## Index by Code

Code	Page	Code	Page	Code	Page	Code	Page
11-3125-23	24	11-3316-11	32	11-3475-18	38	11-3610-17T	46
11-3125-25	24	11-3320-15	32	11-3476-18	38	11-3610-23T	46
11-3125-28	24	11-3320-18	32	11-3480-18	38	11-3615-14T	46
11-3125-30	24	11-3325-15	32	11-3481-18	38	11-3615-17T	46
11-3130-16	24	11-3325-18	32	11-3485-23	38	11-3615-23T	46
11-3130-21	24	11-3335-13	32	11-3486-23	38	11-3620-15T	47
11-3135-16	24	11-3335-15	32	11-3490-21	40	11-3620-17T	47
11-3135-21	24	11-3340-14	32	11-3495-21	40	11-3625-15T	47
11-3140-16	25	11-3341-14	32	11-3500-13	40	11-3625-17T	47
11-3145-16	25	11-3345-11	33	11-3505-11	41	11-3630-16T	47
11-3150-10	25	11-3346-11	33	11-3506-11	41	11-3630-21T	47
11-3151-10	25	11-3350-09	33	11-3510-09	41	11-3635-16T	47
11-3154-19	26	11-3350-10	33	11-3515-11	41	11-3635-21T	47
11-3155-19	26	11-3351-09	33	11-3520-12	41	11-3640-16T	47
11-3156-19	26	11-3351-10	33	11-3525-09	41	11-3641-16T	47
11-3157-19	26	11-3355-09	33	11-3530-18	42	11-3645-10T	47
11-3159-19	26	11-3355-10	33	11-3531-18	42	11-3645-12T	47
11-3160-19	26	11-3356-09	33	11-3532-18	42	11-3650-10T	47
11-3161-19	26	11-3356-10	33	11-3535-18	42	11-3650-12T	47
11-3162-19	26	11-3360-11	33	11-3536-18	42	11-3655-14T	48
11-3165-21	26	11-3361-10	33	11-3537-18	42	11-3655-16T	48
11-3165-24	26	11-3362-10	33	11-3538-18	42	11-3655-20T	48
11-3170-19	26	11-3365-11	33	11-3539-18	42	11-3655-23T	48
11-3175-11	26	11-3366-10	33	11-3540-18	43	11-3655-25T	48
11-3180-18	26	11-3367-10	33	11-3541-18	43	11-3655-28T	48
11-3180-18B	26	11-3370-11	33	11-3542-18	43	11-3655-30T	48
11-3181-18	26	11-3371-10	33	11-3543-18	43	11-3660-14T	48
11-3181-18B	26	11-3372-10	33	11-3544-18	43	11-3660-18T	48
11-3182-17	26	11-3375-11	33	11-3545-18	43	11-3660-20T	48
11-3182-17B	26	11-3376-10	33	11-3546-18	43	11-3660-23T	48
11-3183-17	26	11-3377-10	33	11-3547-18	43	11-3660-25T	48
11-3183-17B	26	11-3380-11	34	11-3548-18	43	11-3660-28T	48
11-3184-17	26	11-3381-11	34	11-3552-22	44	11-3660-30T	48
11-3184-17B	26	11-3385-15	34	11-3556-22	44	11-3665-20T	49
11-3200-15	27	11-3390-09	34	11-3557-22	44	11-3665-23T	49
11-3205-15	27	11-3391-09	34	11-3558-22	44	11-3665-28T	49
11-3210-15	27	11-3392-09	34	11-3560-15	44	11-3670-17T	49
11-3215-30	28	11-3395-11	34	11-3561-15	44	11-3675-14T	50
11-3220-24	28	11-3396-11	34	11-3565-15	44	11-3680-28T	52
11-3225-23	28	11-3397-11	34	11-3566-15	44	11-3681-28T	52
11-3230-18	29	11-3398-11	34	11-3570-09T	45	11-3685-20T	52
11-3235-18	29	11-3400-13	34	11-3570-11T	45	11-3686-20T	52
11-3236-18	29	11-3405-11	34	11-3570-14T	45	11-3690-23T	52
11-3240-17	29	11-3406-11	34	11-3570-16T	45	11-3691-23T	52
11-3245-17	29	11-3410-10	35	11-3570-18T	45	11-3695-19T	53
11-3246-17	29	11-3415-10	35	11-3570-20T	45	11-3696-19T	53
11-3250-17	29	11-3420-10	35	11-3580-14T	46	11-3697-19T	53
11-3255-22	29	11-3425-10	35	11-3580-16T	46	11-3700-23T	53
11-3260-18	30	11-3430-10	35	11-3580-18T	46	11-3701-23T	53
11-3265-18	30	11-3435-10	35	11-3585-14T	46	11-3702-23T	53
11-3270-15	30	11-3436-10	35	11-3585-16T	46	11-3705-15T	53
11-3275-16	30	11-3437-10	35	11-3585-18T	46	11-3710-16T	53
11-3280-18	30	11-3438-10	35	11-3590-14T	46	11-3715-18T	53
11-3281-18	30	11-3440-12	36	11-3590-16T	46	11-3716-18T	53
11-3282-18	30	11-3445-12	36	11-3590-18T	46	11-3717-18T	53
11-3285-14	31	11-3450-11	37	11-3595-14T	46	11-3745-11T	54
11-3285-18	31	11-3450-14	37	11-3595-16T	46	11-3745-14T	54
11-3290-22	31	11-3455-11	37	11-3595-18T	46	11-3746-11T	54
11-3295-18	31	11-3455-14	37	11-3600-14T	46	11-3746-14T	54
11-3300-16	31	11-3460-15	37	11-3600-16T	46	11-3750-15T	54
11-3301-16	31	11-3460-18	37	11-3600-18T	46	11-3750-18T	54
11-3305-15	31	11-3465-15	37	11-3605-14T	46	11-3751-15T	54
11-3310-10	31	11-3465-18	37	11-3605-16T	46	11-3751-18T	54
11-3310-12	31	11-3470-18	37	11-3605-18T	46	11-3755-18T	54
11-3315-11	32	11-3471-18	37	11-3610-14T	46	11-3760-18T	55

Code	Page
11-3761-18T	55
11-3765-18T	55
11-3766-18T	55
11-3770-23T	55
11-3771-23T	55
12-0201-10	56
12-0201-11	56
12-0201-13	56
12-0201-14	56
12-0201-16	56
12-0201-18	56
12-0201-20	56
12-0201-23	56
12-0201-25	56
12-0201-30	56
12-0221-10	56
12-0221-11	56
12-0221-13	56
12-0221-14	56
12-0221-16	56
12-0221-18	56
12-0221-20	56
12-0221-23	56
12-0221-25	56
12-0221-30	56
12-0269-12	58
12-0269-15	58
12-0271-15	58
12-0333-17T	67
12-0335-17T	67
12-0337-15T	67
12-0339-15T	67
12-0341-16T	69
12-0341-18T	69
12-0343-16T	69
12-0343-18T	69
12-0345-12T	68
12-0347-12T	68
12-0347-15T	68
12-0351-12T	68
12-0351-15T	68
12-0353-12T	68
12-0353-15T	68
12-0355-17T	69
12-0355-20T	69
12-0355-25T	69
12-0356-18T	69
12-0357-18	60
12-0357-18T	69
12-0402-10	56
12-0402-11	56
12-0402-13	56
12-0402-14	56
12-0402-16	56
12-0402-18	56
12-0402-20	56
12-0402-23	56
12-0402-25	56
12-0402-30	56
12-0424-18	60
12-0444-18	60
12-0469-12	58
12-0469-15	58
12-0471-15	58
12-0487-17	60

Code	Page
12-0488-17	60
12-0501-12	63
12-0505-12	63
12-0821-13	64
12-0822-13	64
12-0826-11	64
12-0841-15	64
12-0842-15	64
12-2001-15	58
12-3001-12	56
12-3001-15	56
12-3001-18	56
12-3001-20	56
12-3005-12	56
12-3005-15	56
12-3005-18	56
12-3010-12	56
12-3010-15	56
12-3010-18	56
12-3015-12	56
12-3015-15	56
12-3015-18	56
12-3020-10	56
12-3020-11	56
12-3020-13	56
12-3020-14	56
12-3020-16	56
12-3020-18	56
12-3020-20	56
12-3020-23	56
12-3020-25	56
12-3020-30	56
12-3025-13	57
12-3025-14	57
12-3025-16	57
12-3030-13	57
12-3030-14	57
12-3030-16	57
12-3035-10	57
12-3035-13	57
12-3035-14	57
12-3035-15	57
12-3035-18	57
12-3035-21	57
12-3035-25	57
12-3035-31	57
12-3040-12	57
12-3040-13	57
12-3040-14	57
12-3040-15	57
12-3045-12	57
12-3045-13	57
12-3045-14	57
12-3045-15	57
12-3045-18	57
12-3045-21	57
12-3045-25	57
12-3045-31	57
12-3050-15	57
12-3055-15	57
12-3060-15	57
12-3065-13	58
12-3065-14	58
12-3065-16	58
12-3075-12	58

Code	Page
12-3075-15	58
12-3075-18	58
12-3075-20	58
12-3080-12	58
12-3080-15	58
12-3080-18	58
12-3080-20	58
12-3085-15	58
12-3085-18	58
12-3085-20	58
12-3090-15	58
12-3090-18	58
12-3090-20	58
12-3095-12	58
12-3095-15	58
12-3100-12	58
12-3100-15	58
12-3105-18	59
12-3105-21	59
12-3105-25	59
12-3110-18	59
12-3110-21	59
12-3110-25	59
12-3115-17	59
12-3116-17	59
12-3120-17	59
12-3121-17	59
12-3125-17	59
12-3130-17	59
12-3135-17	59
12-3140-17	59
12-3145-17	60
12-3150-18	60
12-3155-20	60
12-3156-20	60
12-3160-20	60
12-3165-15	60
12-3170-15	60
12-3175-20	61
12-3180-23	61
12-3185-23	61
12-3190-23	61
12-3195-15	61
12-3195-20	61
12-3195-25	61
12-3200-23	61
12-3205-14	62
12-3205-16	62
12-3205-20	62
12-3210-18	62
12-3211-18	62
12-3215-18	62
12-3216-18	62
12-3220-14	62
12-3225-20	62
12-3226-20	62
12-3230-12	63
12-3231-12	63
12-3235-11	63
12-3236-11	63
12-3237-11	63
12-3240-11	63
12-3241-11	63
12-3242-11	63
12-3245-07	63

Code	Page
12-3245-09	63
12-3245-11	63
12-3250-12	63
12-3255-10	64
12-3256-10	64
12-3260-10	64
12-3261-10	64
12-3265-12	64
12-3270-09	64
12-3275-11	65
12-3280-11	65
12-3285-13	65
12-3290-11	65
12-3295-11	65
12-3300-11	65
12-3305-11	65
12-3310-08	66
12-3315-09	66
12-3320-09	66
12-3325-09	66
12-3330-09	66
12-3335-09	66
12-3340-12	66
12-3345-10	66
12-3350-18T	67
12-3355-15T	67
12-3355-18T	67
12-3355-20T	67
12-3355-23T	67
12-3355-25T	67
12-3360-17T	67
12-3361-17T	67
12-3365-14T	68
12-3365-16T	68
12-3365-18T	68
12-3365-20T	68
12-3365-25T	68
12-3365-30T	68
12-3370-14T	68
12-3370-20T	68
12-3370-25T	68
12-3375-15T	69
12-3380-15T	69
12-3380-19T	69
12-3380-24T	69
12-3381-15T	69
12-3381-19T	69
12-3381-24T	69
12-3385-18T	70
12-3390-15T	70
12-3390-23T	70
12-3390-25T	70
12-3395-14T	70
12-3395-18T	70
12-3400-20T	70
12-3400-25T	70
12-3405-23T	70
13-0407-10	72
13-0408-10	72
13-0411-12	72
13-0412-12	72
13-0413-12	72
13-0415-12	72
13-0421-10	72
13-0421-12	72

Index by Code

Code	Page
13-0422-10	72
13-0422-12	72
13-0423-10	72
13-0423-12	72
13-0424-10	72
13-0424-12	72
13-0425-14	73
13-0426-14	73
13-0427-15	76
13-0428-15	76
13-0429-15	76
13-0430-15	76
13-0431-14	74
13-0432-14	74
13-0435-16	74
13-0436-16	74
13-0441-14	74
13-0442-14	74
13-0447-16	74
13-0448-16	74
13-0456-14	76
13-0458-14	76
13-0511-14	79
13-0511-16	79
13-0511-18	79
13-0511-20	79
13-0511-22	79
13-0511-24	79
13-0511-26	79
13-0511-30	79
13-0512-14	79
13-0512-16	79
13-0512-18	79
13-0512-20	79
13-0512-22	79
13-0512-24	79
13-0512-26	79
13-0512-30	79
13-0515-14	79
13-0515-16	79
13-0515-18	79
13-0515-20	79
13-0515-22	79
13-0515-24	79
13-0515-26	79
13-0515-30	79
13-0516-14	79
13-0516-16	79
13-0516-18	79
13-0516-20	79
13-0516-22	79
13-0516-24	79
13-0516-26	79
13-0516-30	79
13-0520-18	89
13-0976-09	102
13-0982-05	102
13-0982-09	102
13-1016-09	102
13-1016-11	102
13-1016-13	102
13-1016-15	102
13-1020-10	102
13-1020-13	102
13-1024-10	103

Code	Page
13-1024-13	103
13-3001-03	71
13-3005-03	71
13-3010-04	71
13-3015-04	71
13-3020-03	71
13-3020-04	71
13-3025-03	71
13-3025-04	71
13-3030-05	71
13-3035-05	71
13-3040-05	71
13-3040-06	71
13-3040-07	71
13-3045-05	71
13-3045-06	71
13-3045-07	71
13-3050-09	72
13-3050-12	72
13-3050-18	72
13-3050-20	72
13-3051-09	72
13-3051-12	72
13-3051-18	72
13-3051-20	72
13-3052-09	72
13-3052-10	72
13-3052-12	72
13-3052-18	72
13-3052-20	72
13-3053-09	72
13-3053-10	72
13-3053-12	72
13-3053-18	72
13-3053-20	72
13-3055-09	72
13-3056-09	72
13-3057-09	72
13-3058-09	72
13-3060-09	73
13-3060-10	73
13-3060-12	73
13-3061-09	73
13-3061-10	73
13-3061-12	73
13-3065-10	73
13-3070-10	73
13-3075-12	73
13-3080-18	74
13-3081-18	74
13-3085-14	74
13-3086-14	74
13-3090-16	74
13-3091-16	74
13-3095-18	74
13-3096-18	74
13-3097-18	74
13-3098-18	74
13-3100-14	75
13-3101-14	75
13-3105-16	75
13-3105-18	75
13-3106-16	75
13-3106-18	75
13-3110-14	75

Code	Page
13-3111-14	75
13-3112-14	75
13-3113-14	75
13-3115-16	75
13-3116-16	75
13-3117-16	75
13-3118-16	75
13-3120-18	75
13-3121-18	75
13-3122-18	75
13-3123-18	75
13-3125-16	76
13-3126-16	76
13-3127-16	76
13-3128-16	76
13-3130-14	76
13-3131-14	76
13-3135-12	76
13-3140-15	77
13-3141-15	77
13-3145-14	77
13-3146-14	77
13-3150-14	77
13-3151-14	77
13-3155-18	77
13-3156-18	77
13-3160-12	77
13-3160-14	77
13-3160-16	77
13-3161-12	77
13-3161-14	77
13-3161-16	77
13-3165-14	77
13-3166-14	77
13-3169-12	78
13-3169-15	78
13-3169-18	78
13-3169-20	78
13-3169-23	78
13-3170-12	78
13-3170-15	78
13-3170-18	78
13-3170-20	78
13-3170-23	78
13-3173-12	78
13-3173-15	78
13-3173-18	78
13-3173-20	78
13-3173-23	78
13-3174-12	78
13-3174-15	78
13-3174-18	78
13-3174-20	78
13-3174-23	78
13-3177-12	78
13-3177-15	78
13-3177-18	78
13-3177-20	78
13-3178-12	78
13-3178-15	78
13-3178-18	78
13-3178-20	78
13-3180-13	78
13-3180-14	78
13-3180-17	78

Code	Page
13-3181-13	78
13-3181-14	78
13-3181-17	78
13-3183-13	78
13-3183-14	78
13-3183-16	78
13-3184-13	78
13-3184-14	78
13-3184-16	78
13-3186-14	79
13-3186-16	79
13-3186-18	79
13-3186-20	79
13-3186-22	79
13-3186-24	79
13-3186-26	79
13-3186-30	79
13-3187-14	79
13-3187-16	79
13-3187-18	79
13-3187-20	79
13-3187-22	79
13-3187-24	79
13-3187-26	79
13-3187-30	79
13-3190-14	79
13-3190-16	79
13-3190-18	79
13-3190-20	79
13-3190-22	79
13-3190-24	79
13-3190-26	79
13-3190-30	79
13-3191-14	79
13-3191-16	79
13-3191-18	79
13-3191-20	79
13-3191-22	79
13-3191-24	79
13-3191-26	79
13-3191-30	79
13-3193-14	80
13-3193-16	80
13-3193-18	80
13-3194-14	80
13-3194-16	80
13-3194-18	80
13-3197-14	80
13-3197-16	80
13-3197-18	80
13-3198-14	80
13-3198-16	80
13-3198-18	80
13-3200-16	80
13-3201-16	80
13-3203-01	80
13-3203-02	80
13-3203-03	80
13-3204-01	80
13-3204-02	80
13-3205-18	81
13-3206-18	81
13-3207-18	81
13-3208-18	81
13-3210-16	81

Index by Code

Code	Page
13-3210-20	81
13-3211-16	81
13-3211-20	81
13-3212-20	81
13-3212-26	81
13-3213-20	81
13-3213-26	81
13-3214-20	81
13-3214-26	81
13-3215-20	81
13-3215-26	81
13-3218-15	81
13-3218-18	81
13-3219-15	81
13-3219-18	81
13-3220-13	82
13-3220-16	82
13-3225-13	82
13-3230-12	82
13-3230-18	82
13-3235-14	82
13-3240-12	82
13-3240-15	82
13-3240-19	82
13-3241-12	82
13-3241-15	82
13-3241-19	82
13-3245-15	82
13-3245-20	82
13-3250-12	83
13-3251-12	83
13-3255-16	83
13-3256-16	83
13-3257-16	83
13-3258-16	83
13-3260-16	83
13-3265-16	83
13-3266-18	83
13-3266-20	83
13-3266-22	83
13-3270-16	83
13-3270-18	83
13-3270-20	83
13-3270-22	83
13-3275-15	84
13-3280-14	84
13-3285-19	84
13-3290-21	84
13-3295-17	84
13-3295-20	84
13-3296-17	84
13-3296-20	84
13-3300-21	85
13-3301-21	85
13-3302-22	85
13-3303-22	85
13-3304-22	85
13-3305-29	85
13-3306-29	85
13-3307-30	85
13-3310-21	85
13-3310-27	85
13-3311-21	85
13-3311-27	85
13-3312-21	85

Code	Page
13-3312-27	85
13-3313-21	85
13-3313-27	85
13-3314-21	85
13-3314-27	85
13-3315-21	85
13-3315-27	85
13-3316-21	85
13-3316-27	85
13-3320-24	86
13-3321-24	86
13-3322-24	86
13-3323-24	86
13-3324-24	86
13-3330-24	86
13-3331-24	86
13-3332-24	86
13-3335-24	86
13-3340-24	86
13-3341-24	86
13-3345-24	86
13-3346-24	86
13-3350-23	87
13-3351-23	87
13-3355-22	87
13-3356-22	87
13-3360-13	87
13-3361-16	87
13-3362-18	87
13-3363-20	87
13-3364-23	87
13-3365-25	87
13-3366-28	87
13-3370-20	88
13-3375-27	88
13-3380-29	88
13-3381-29	88
13-3385-21	89
13-3385-26	89
13-3386-21	89
13-3386-26	89
13-3387-21	89
13-3387-26	89
13-3388-21	89
13-3388-26	89
13-3390-14	89
13-3391-14	89
13-3395-14	89
13-3400-15	90
13-3405-05	90
13-3405-18	90
13-3410-22	90
13-3415-23	90
13-3420-18	91
13-3425-22	91
13-3425-25	91
13-3425-28	91
13-3430-18	91
13-3435-19	91
13-3435-23	91
13-3440-24	92
13-3445-19	92
13-3446-19	92
13-3450-19	92
13-3451-19	92

Code	Page
13-3455-18	92
13-3456-18	92
13-3460-19	93
13-3461-19	93
13-3465-20	93
13-3465-22	93
13-3465-24	93
13-3470-23	93
13-3475-23	94
13-3480-23	94
13-3485-23	94
13-3490-23	94
13-3495-20	95
13-3500-22	95
13-3500-23	95
13-3505-22	95
13-3505-23	95
13-3510-18	95
13-3515-21	96
13-3520-21	96
13-3525-14	96
13-3530-20	96
13-3535-20	96
13-3540-21	97
13-3541-21	97
13-3545-20	97
13-3546-20	97
13-3550-22	97
13-3550-23	97
13-3555-22	97
13-3555-23	97
13-3560-24	98
13-3565-25	98
13-3570-21	98
13-3575-23	98
13-3575-24	98
13-3580-20	98
13-3580-25	98
13-3585-19	99
13-3585-21	99
13-3585-24	99
13-3590-19	99
13-3590-21	99
13-3590-24	99
13-3595-21	99
13-3596-21	99
13-3600-21	99
13-3601-21	99
13-3605-22	100
13-3606-21	100
13-3607-22	100
13-3608-20	100
13-3610-25	100
13-3611-24	100
13-3612-24	100
13-3613-22	100
13-3615-24	101
13-3616-24	101
13-3617-24	101
13-3620-25	101
13-3620-26	101
13-3620-27	101
13-3625-09	102
13-3630-11	102
13-3630-13	102

Code	Page
13-3630-15	102
13-3635-11	103
13-3635-14	103
13-3636-11	103
13-3636-14	103
13-3640-15	103
13-3645-16	103
13-3650-18	103
13-3655-13	103
13-3660-14	104
13-3665-14	104
13-3665-16	104
13-3665-18	104
13-3670-16	104
13-3671-16	104
13-3675-14	104
13-3675-15	104
13-3675-18	104
13-3675-20	104
13-3680-14	104
13-3680-15	104
13-3680-18	104
13-3680-20	104
13-3685-18	104
13-3686-18	104
14-0245-18	105
14-0245-20	105
14-0246-18	105
14-0246-20	105
14-0247-18	105
14-0247-20	105
14-0248-18	105
14-0248-20	105
14-0323-20	106
14-0323-25	106
14-0324-20	106
14-0324-25	106
14-2001-20	106
14-2001-25	106
14-2001-26	106
14-2005-20	106
14-2005-25	106
14-2005-26	106
14-3001-13	105
14-3002-13	105
14-3005-13	105
14-3005-15	105
14-3005-16	105
14-3005-17	105
14-3010-22	106
14-3010-26	106
14-3011-22	106
14-3011-26	106
14-3015-28	106
14-3016-28	106
14-3020-26	107
14-3021-26	107
14-3025-25	107
14-3030-25	107
14-3035-25	108
14-3040-26	108
14-3041-26	108
14-3045-24	108
14-3050-26	108
14-3055-25	109

## Index by Code

Code	Page	Code	Page	Code	Page	Code	Page
14-3056-18	109	15-3001-15	121	15-3166-16	129	15-3280-22	134
14-3056-20	109	15-3005-11	121	15-3170-16	129	15-3281-22	134
14-3056-25	109	15-3010-16	122	15-3171-16	129	15-3282-22	134
14-3057-25	109	15-3015-21	122	15-3172-16	129	15-3283-22	134
14-3058-18	109	15-3020-20	122	15-3173-16	129	15-3284-22	134
14-3058-20	109	15-3025-17	122	15-3175-20	129	15-3285-20	134
14-3058-24	109	15-3030-16	122	15-3176-20	129	15-3290-00	134
14-3060-18	109	15-3030-20	122	15-3177-20	129	15-3291-00	134
14-3060-25	109	15-3030-25	122	15-3180-20	129	15-3295-21	135
14-3065-18	109	15-3030-30	122	15-3181-20	129	15-3300-21	135
14-3065-24	109	15-3035-28	123	15-3182-20	129	15-3305-23	135
14-3066-18	109	15-3036-28	123	15-3185-24	129	15-3306-23	135
14-3066-24	109	15-3040-22	123	15-3186-24	129	15-3307-23	135
15-0201-01	127	15-3045-18	123	15-3187-24	129	15-3308-23	135
15-0201-02	127	15-3045-20	123	15-3190-24	129	15-3309-23	135
15-0201-03	127	15-3050-18	124	15-3191-24	129	15-3315-00	136
15-0201-04	127	15-3055-21	124	15-3192-24	129	15-3316-00	136
15-0202-01	127	15-3060-23	124	15-3195-00	130	15-3317-00	136
15-0202-02	127	15-3065-30	124	15-3196-00	130	15-3320-00	136
15-0202-03	127	15-3070-33	124	15-3197-00	130	15-3321-00	136
15-0202-04	127	15-3075-36	124	15-3198-00	130	15-3322-00	136
15-0262-01	130	15-3080-30	125	15-3199-00	130	15-3325-22	137
15-0262-02	130	15-3085-30	125	15-3200-00	130	15-3330-22	137
15-0265-14	130	15-3090-30	125	15-3205-24	130	15-3335-25	137
15-0267-16	130	15-3095-31	126	15-3206-24	130	15-3336-25	137
15-0268-16	130	15-3096-31	126	15-3207-24	130	15-3337-25	137
15-0321-01	131	15-3097-31	126	15-3210-24	130	15-3340-24	138
15-0321-02	131	15-3098-31	126	15-3211-24	130	15-3341-24	138
15-0321-03	131	15-3099-31	126	15-3212-24	130	15-3342-24	138
15-0321-04	131	15-3105-32	126	15-3215-23	131	15-3345-24	138
15-0321-06	131	15-3106-32	126	15-3216-23	131	15-3350-26	138
15-0322-01	131	15-3110-16	127	15-3217-23	131	15-3351-26	138
15-0322-02	131	15-3111-16	127	15-3218-23	131	15-3352-26	138
15-0322-03	131	15-3112-16	127	15-3219-23	131	15-3355-26	138
15-0322-04	131	15-3113-16	127	15-3225-23	131	15-3355-28	138
15-0322-06	131	15-3115-16	127	15-3226-23	131	15-3355-30	138
15-0394-01	134	15-3116-16	127	15-3227-23	131	15-3360-00	139
15-0394-02	134	15-3117-16	127	15-3228-23	131	15-3361-00	139
15-0394-03	134	15-3118-16	127	15-3229-23	131	15-3362-00	139
15-0394-04	134	15-3120-16	127	15-3235-19	132	15-3365-24	139
15-0394-05	134	15-3121-16	127	15-3236-19	132	15-3370-24	139
15-0418-01	136	15-3122-16	127	15-3237-19	132	15-3371-24	139
15-0418-02	136	15-3125-16	127	15-3238-19	132	15-3372-24	139
15-0418-03	136	15-3126-16	127	15-3240-19	132	15-3373-24	139
15-0418-04	136	15-3127-16	127	15-3241-19	132	15-3375-25	139
15-0418-05	136	15-3130-16	128	15-3242-19	132	15-3380-23	140
15-0418-06	136	15-3131-16	128	15-3243-19	132	15-3385-28	140
15-0418-07	136	15-3132-16	128	15-3245-22	132	15-3390-27	140
15-0418-08	136	15-3133-16	128	15-3246-22	132	15-3391-27	140
15-0418-09	136	15-3135-16	128	15-3247-22	132	15-3392-27	140
15-0462-01	137	15-3136-16	128	15-3248-22	132	15-3395-26	141
15-0462-02	137	15-3140-16	128	15-3249-22	132	15-3400-26	141
15-0462-03	137	15-3145-16	128	15-3250-22	132	15-3401-26	141
15-0756-00	121	15-3146-16	128	15-3255-22	132	15-3402-26	141
15-0756-01	121	15-3150-16	129	15-3256-22	132	15-3405-27	141
15-0756-02	121	15-3151-16	129	15-3257-22	132	15-3406-27	141
15-0756-03	121	15-3152-16	129	15-3258-22	132	15-3410-21	142
15-0756-04	121	15-3153-16	129	15-3259-22	132	15-3410-23	142
15-0764-00	121	15-3154-16	129	15-3260-22	132	15-3410-25	142
15-0766-00	121	15-3155-16	129	15-3265-00	133	15-3415-16	142
15-0768-06	121	15-3160-16	129	15-3270-23	133	15-3416-16	142
15-0770-13	121	15-3161-16	129	15-3275-25	133	15-3420-00	142
15-0774-01	121	15-3162-16	129	15-3276-25	133	15-3425-29	143
15-0774-02	122	15-3163-16	129	15-3277-25	133	15-3430-32	143
15-0796-00	123	15-3165-16	129	15-3278-25	133	15-3435-32	143



Code	Page
15-3440-33	144
15-3441-33	144
15-3442-33	144
15-3445-33	144
15-3446-33	144
15-3447-33	144
15-3450-07	145
15-3451-07	145
15-3455-07	145
15-3456-07	145
15-3460-08	145
15-3465-06	145
15-3470-07	145
15-3470-10	145
15-3471-07	145
15-3471-10	145
15-3475-10	145
15-3476-00	145
15-3480-10	145
15-3481-10	145
15-3485-10	145
15-3490-10	146
15-3491-10	146
15-3495-14	146
15-3495-16	146
15-3495-18	146
15-3495-20	146
15-3495-24	146
15-3496-14	146
15-3496-16	146
15-3496-18	146
15-3496-20	146
15-3496-24	146
15-3500-13	146
15-3505-14	146
15-3506-14	146
15-3510-14	147
15-3515-15	147
15-3520-13	147
15-3525-13	147
15-3530-11	147
15-3535-11	147
15-3540-13	147
15-3545-13	148
15-3550-13	148
15-3560-14	148
15-3565-22	148
15-3570-20	148
15-3575-13	148
15-3576-13	148
15-3580-16	148
15-3581-16	148
15-3585-20	148
15-3590-26	149
15-3591-26	149
15-3592-26	149
15-3595-26	149
15-3596-26	149
15-3597-26	149
15-3600-14	149
15-3600-16	149
15-3600-20	149
15-3605-14	149
15-3605-16	149
15-3605-20	149

Code	Page
15-3610-28	149
15-3615-19	150
15-3615-20	150
15-3620-19	150
15-3625-27	150
15-3626-27	150
15-3630-31	151
15-3635-32	151
15-3640-31	151
15-3641-31	151
15-3645-31	151
15-3646-31	151
15-3650-32	152
15-3655-31	152
15-3660-09	153
15-3660-11	153
15-3660-14	153
15-3660-16	153
15-3660-18	153
15-3660-20	153
15-3665-09	153
15-3665-11	153
15-3665-14	153
15-3665-16	153
15-3665-18	153
15-3670-18	153
15-3675-18	153
15-3680-17	153
15-3685-17	153
15-3690-00	154
15-3691-00	154
15-3692-00	154
15-3693-00	154
15-3695-18	154
15-3700-18	154
15-3705-12	154
15-3705-18	154
15-3710-12	154
15-3710-18	154
15-3715-20	155
15-3720-15	155
15-3725-25	155
15-3726-25	155
15-3730-28	155
15-3731-28	155
15-3735-00	155
15-3736-00	155
15-3737-00	155
15-3738-00	155
15-3740-00	156
15-3745-00	156
15-3750-16	156
15-3755-08	156
15-3760-28	156
15-3761-28	156
15-3762-28	156
15-3763-28	156
15-3765-30	156
15-3766-30	156
15-3767-30	156
15-3768-30	156
15-3770-31	157
15-3771-31	157
15-3772-31	157
15-3773-31	157

Code	Page
15-3774-31	157
15-3775-19	157
15-3780-28	157
15-3781-28	157
15-3782-28	157
15-3783-28	157
15-3785-00	157
15-3786-00	157
15-3790-00	158
15-3795-00	158
15-3800-00	158
15-3805-00	158
15-3806-00	158
15-3810-00	159
15-3815-00	159
15-3820-00	159
15-3825-00	160
15-3830-00	160
15-3831-00	160
15-3835-00	160
15-3840-00	161
15-3841-00	161
15-3842-00	161
15-3845-00	161
15-3850-00	161
15-3851-00	161
15-3852-00	161
15-3855-00	161
15-3860-00	162
15-3861-00	162
15-3862-00	162
15-3865-00	162, 163
15-3866-00	162-164
15-3867-00	162, 164
15-3868-00	162
15-3869-00	162
15-3870-00	162
15-3871-00	162
15-3875-00	163
15-3876-00	163
15-3880-00	163
15-3885-00	163
15-3886-00	163
15-3890-00	163
15-3891-00	163
15-3895-00	164
15-3900-00	164
15-3905-00	164
15-3906-00	164
15-3910-00	165
15-3911-00	165
15-3915-00	165
15-3916-00	165
15-3920-00	166
15-3925-00	166
15-3930-00	166
15-3935-00	166
15-3940-00	166
15-3941-00	166
15-3942-00	166
15-3945-00	166
15-3946-00	166
15-3947-00	166
15-3948-00	166
15-3950-00	166

Code	Page
15-3951-00	166
15-3955-16	167
15-3956-16	167
15-3957-16	167
15-3958-16	167
15-3959-16	167
15-3965-25	167
15-3966-25	167
15-3967-25	167
15-3968-25	167
15-3969-25	167
15-4001-22	168
15-4005-22	168
15-4010-22	168
15-4015-00	168
15-4016-00	168
15-4017-00	168
15-4020-29	168
15-4025-28	168
15-4030-20	168
15-4030-28	168
15-4030-30	168
15-4035-33	168
15-4036-33	168
15-4037-33	168
16-2070-25	169
16-2075-20	169
16-3035-37	169
16-3035-45	169
17-3060-10	1
17-3065-00	1
17-3070-00	1
17-3075-00	1
17-3080-00	1
17-3085-34	1
17-3090-00	1
17-3095-08	2
17-3100-08	2
17-3105-08	2
17-3110-09	2
17-3115-18	2
17-3120-18	2
18-0591-18	8
18-0596-03	8
18-0596-04	8
18-0596-05	8
18-0606-55	8
18-0616-22	8
18-0620-03	8
18-0621-11	8
18-0622-21	10
18-0623-10	10
18-0624-06	10
18-0624-07	10
18-0624-08	10
18-0624-09	10
18-0624-10	10
18-0624-11	10
18-0624-12	10
18-0624-14	10
18-0624-16	10
18-0641-15	10
18-0641-20	10
18-0641-25	10
18-0641-30	10

Index by Code

Code	Page
18-0644-23	9
18-0644-27	9
18-0651-22	9
18-0652-22	9
18-0676-01	10
18-0676-02	10
18-0676-03	10
18-0676-04	10
18-0676-05	10
18-0676-06	10
18-0676-07	10
18-0676-08	10
18-2001-00	9
18-2001-01	9
18-2001-23	9
18-2002-27	9
18-3001-00	6
18-3002-00	6
18-3005-11	6
18-3006-11	6
18-3007-11	6
18-3008-11	6
18-3009-11	6
18-3010-11	6
18-3011-11	6
18-3015-12	6
18-3016-12	6
18-3017-12	6
18-3018-12	6
18-3019-12	6
18-3020-12	6
18-3021-12	6
18-3025-12	6
18-3026-12	6
18-3027-12	6
18-3028-12	6
18-3029-12	6
18-3030-12	6
18-3031-12	6
18-3035-21	6
18-3036-21	6
18-3037-21	6
18-3040-11	6
18-3045-16	7
18-3046-16	7
18-3050-23	7
18-3055-23	7
18-3060-24	7
18-3065-14	7
18-3066-14	7
18-3067-14	7
18-3070-24	7
18-3071-24	7
18-3075-00	8
18-3080-22	9
18-3085-22	9
18-3090-00	11
18-3091-00	11
18-3092-00	11
18-3093-00	11
18-3094-00	11
18-3095-00	11
18-3096-00	11
18-3097-00	11
18-3098-00	11

Code	Page
18-3100-00	11
18-3101-00	11
18-3102-00	11
18-3103-00	11
18-3104-00	11
18-3105-00	11
18-3106-00	11
18-3107-00	11
18-3108-00	11
18-3110-14	11
18-3111-14	11
18-3112-14	11
18-3113-14	11
18-3115-00	11
18-3116-00	11
18-3117-00	11
18-3118-00	11
18-3119-00	11
18-3120-00	11
18-3125-00	11
18-3125-18	3
18-3126-00	11
18-3126-20	3
18-3127-00	11
18-3130-00	11
18-3130-18	3
18-3131-00	11
18-3131-20	3
18-3132-00	11
18-3135-19	12
18-3135-20	3
18-3136-19	12
18-3136-20	3
18-3137-19	12
18-3138-19	12
18-3139-19	12
18-3140-19	12
18-3140-21	3
18-3141-21	3
18-3142-00	3
18-3145-18	3
18-3145-19	12
18-3146-18	3
18-3146-19	12
18-3147-00	3
18-3147-19	12
18-3148-00	3
18-3148-19	12
18-3149-00	3
18-3149-19	12
18-3150-00	3
18-3150-19	12
18-3155-17	3
18-3155-19	12
18-3155-20	3
18-3156-19	12
18-3157-19	12
18-3158-19	12
18-3159-19	12
18-3160-19	12
18-3160-24	3
18-3161-24	3
18-3162-00	3
18-3163-00	3
18-3165-19	3

Code	Page
18-3166-19	3
18-3170-25	4
18-3171-00	4
18-3172-00	4
18-3175-35	4
18-3176-35	4
18-3177-35	4
18-3178-35	4
18-3180-23	4
19-0402-15	5
19-0402-20	5
19-0402-25	5
20-0375-14	178
20-0389-13	177
20-0389-16	177
20-0389-18	177
20-0389-20	177
20-0389-23	177
20-0390-13	177
20-0390-16	177
20-0390-18	177
20-0390-20	177
20-0390-23	177
20-0391-14	177
20-0401-13	177
20-0401-16	177
20-0401-18	177
20-0401-20	177
20-0401-23	177
20-0405-09	178
20-0406-09	178
20-0407-09	178
20-0407-14	176
20-0408-09	178
20-0408-14	176
20-0413-14	176
20-0414-14	176
20-0415-16	178
20-0416-16	178
20-0417-12	178
20-0417-13	178
20-0418-12	178
20-0427-12	170
20-0429-12	170
20-0433-12	170
20-0435-13	170
20-0437-11	170
20-0437-13	170
20-0439-13	170
20-0441-14	170
20-0449-15	171
20-0451-15	171
20-0451-18	171
20-0451-20	171
20-0461-18	171
20-0465-18	171
20-0491-14	171
20-0491-16	171
20-0491-18	171
20-0491-20	171
20-0491-24	171
20-0491-26	171
20-0497-16	171
20-0497-18	171
20-0497-20	171

Code	Page
20-0565-12	174
20-0565-14	174
20-0565-16	174
20-0565-18	174
20-0567-14	173
20-0570-16	173
20-0601-15	174
20-0617-14	175
20-0617-16	175
20-0617-17	175
20-0617-20	175
20-0617-24	175
20-0627-14	175
20-0627-17	175
20-0637-17	175
20-0637-20	175
20-0677-20	175
20-0705-13T	179
20-0705-15T	179
20-0721-13T	186
20-0721-14T	186
20-0721-16T	186
20-0721-18T	186
20-0721-20T	186
20-0721-21T	186
20-0721-23T	186
20-0722-13T	186
20-0722-14T	186
20-0722-16T	186
20-0722-18T	186
20-0722-20T	186
20-0722-21T	186
20-0722-23T	186
20-0723-16T	188
20-0724-16T	188
20-0731-13T	179
20-0732-13	170
20-0732-13T	179
20-0733-12T	179
20-0735-13T	179
20-0735-14T	179
20-0737-13T	179
20-0738-12T	179
20-0738-13T	179
20-0739-15T	180
20-0739-18T	180
20-0739-20T	180
20-0739-23T	180
20-0739-25T	180
20-0739-30T	180
20-0743-14T	180
20-0743-16T	180
20-0743-18T	180
20-0743-20T	180
20-0743-24T	180
20-0743-26T	180
20-0743-30T	180
20-0743-35T	180
20-0743-40T	180
20-0743-45T	180
20-0747-18T	180
20-0747-20T	180
20-0747-23T	180
20-0747-26T	180
20-0747-31T	180

Index by Code

Code	Page
20-0747-37T	180
20-0751-13T	181
20-0751-15T	181
20-0751-18T	181
20-0751-20T	181
20-0751-23T	181
20-0751-26T	181
20-0773-14T	184
20-0773-16T	184
20-0773-17T	184
20-0773-19T	184
20-0774-15T	184
20-0774-16T	184
20-0777-14T	185
20-0777-17T	185
20-0777-20T	185
20-0779-14T	185
20-0779-17T	185
20-0779-20T	185
20-0785-18T	185
20-0787-20T	185
20-0793-18T	185
20-0793-20T	185
20-0802-15	189
20-0803-15	189
20-0804-15	189
20-0805-15	189
20-0822-19	189
20-0823-19	189
20-0824-19	189
20-0825-19	189
20-0842-23	189
20-0843-23	189
20-0844-23	189
20-0845-23	189
20-2010-12	171
20-2015-12	173
20-2026-10	173
20-2030-14	174
20-2030-16	174
20-2030-18	174
20-2030-20	174
20-2035-14	175
20-2035-16	175
20-2035-17	175
20-2035-20	175
20-2035-24	175
20-2044-10	176
20-2045-14	176
20-2046-14	176
20-2050-13	176
20-2050-16	176
20-2050-18	176
20-2050-20	176
20-2050-23	176
20-2051-13	176
20-2051-16	176
20-2051-18	176
20-2051-20	176
20-2051-23	176
20-2055-13	176
20-2055-16	176
20-2055-18	176
20-2055-20	176
20-2055-23	176

Code	Page
20-2056-13	176
20-2056-16	176
20-2056-18	176
20-2056-20	176
20-2056-23	176
20-2058-14	177
20-2060-16	177
20-2065-12	178
20-2070-12T	179
20-2075-13T	179
20-2095-20T	185
20-2095-24T	185
20-2100-13T	186
20-2100-14T	186
20-2100-16T	186
20-2100-18T	186
20-2100-20T	186
20-2100-21T	186
20-2100-23T	186
20-2105-13T	186
20-2105-14T	186
20-2105-16T	186
20-2105-18T	186
20-2105-20T	186
20-2105-21T	186
20-2105-23T	186
20-2110-12T	188
20-2115-13T	188
20-3001-13	170
20-3005-27	172
20-3010-27	172
20-3015-27	172
20-3020-27	172
20-3025-18	172
20-3025-26	172
20-3030-21	172
20-3035-20	172
20-3040-20	172
20-3040-24	172
20-3045-27	173
20-3050-23	173
20-3055-14	173
20-3055-16	173
20-3055-17	173
20-3055-19	173
20-3060-11	174
20-3065-12	174
20-3070-13	177
20-3070-16	177
20-3070-18	177
20-3070-20	177
20-3070-23	177
20-3071-13	177
20-3071-16	177
20-3071-18	177
20-3071-20	177
20-3071-23	177
20-3075-13	177
20-3080-11T	180
20-3085-13T	181
20-3085-15T	181
20-3085-18T	181
20-3085-20T	181
20-3085-23T	181
20-3085-26T	181

Code	Page
20-3090-14T	181
20-3090-18T	181
20-3090-20T	181
20-3090-23T	181
20-3095-13T	181
20-3095-15T	181
20-3095-18T	181
20-3095-20T	181
20-3095-23T	181
20-3095-26T	181
20-3100-22T	182
20-3100-23T	182
20-3105-22T	182
20-3105-23T	182
20-3110-20T	182
20-3115-20T	182
20-3115-24T	182
20-3115-26T	182
20-3120-27T	183
20-3125-27T	183
20-3130-27T	183
20-3135-18T	184
20-3135-20T	184
20-3135-26T	184
20-3140-20T	184
20-3145-26T	184
20-3150-14T	184
20-3150-16T	184
20-3150-17T	184
20-3150-19T	184
20-3155-12T	184
20-3160-12T	184
20-3165-10T	184
20-3170-10T	186
20-3175-13T	186
20-3176-13T	186
20-3177-13T	186
20-3178-13T	186
20-3180-13T	186
20-3181-13T	186
20-3185-13T	187
20-3185-16T	187
20-3185-18T	187
20-3185-20T	187
20-3185-23T	187
20-3186-13T	187
20-3186-16T	187
20-3186-18T	187
20-3186-20T	187
20-3186-23T	187
20-3190-13T	187
20-3190-16T	187
20-3190-18T	187
20-3190-20T	187
20-3190-23T	187
20-3191-13T	187
20-3191-16T	187
20-3191-18T	187
20-3191-20T	187
20-3191-23T	187
20-3200-13T	187
20-3205-13T	187
20-3205-16T	187
20-3205-18T	187
20-3205-20T	187

Code	Page
20-3205-23T	187
20-3210-14T	187
20-3211-14T	187
20-3215-16T	187
20-3220-09T	188
20-3221-09T	188
20-3225-09T	188
20-3226-09T	188
20-3230-12T	188
20-3235-12T	188
20-3240-13T	188
20-4020-23	190
20-4020-27	190
20-4025-00	190
20-4026-00	190
20-4030-20	190
20-4031-20	190
20-4032-20	190
20-4035-23	190
20-4036-23	190
20-4037-23	190
20-4040-20	190
20-4041-20	190
20-4042-20	190
20-4045-23	190
20-4046-23	190
20-4047-23	190
20-4120-24	191
20-4125-00	191
20-4126-00	191
20-4127-00	191
20-4130-20	191
20-4135-30	191
20-4140-24	191
20-4145-20	192
20-4146-20	192
20-4150-20	192
20-4151-20	192
20-4155-21	192
20-4156-21	192
20-4160-21	193
20-4161-21	193
20-4165-27	193
20-4166-27	193
20-4170-27	194
20-4171-27	194
20-4175-28	194
20-4176-28	194
20-4180-15	195
20-4185-17	195
20-4190-19	195
20-4195-20	195
20-4200-20	196
20-4205-23	196
20-4210-24	196
20-4211-24	196
20-4215-20	197
20-4220-19	197
20-4225-20	197
20-4230-18	197
20-4235-15	197
20-4240-17	197
20-4245-19	197
20-4250-22	197
20-4255-28	198



**ASC MEDICAL** Surgical Instruments and Implants are guaranteed to be free of defects in materials and workmanship for life.

**ASC MEDICAL** Surgical Instruments and Implants that are determined to be defective will be replaced or repaired, at our discretion.

**ASC MEDICAL** Surgical Instruments and Implants not properly cared for or used for purposes not intended will not be covered.

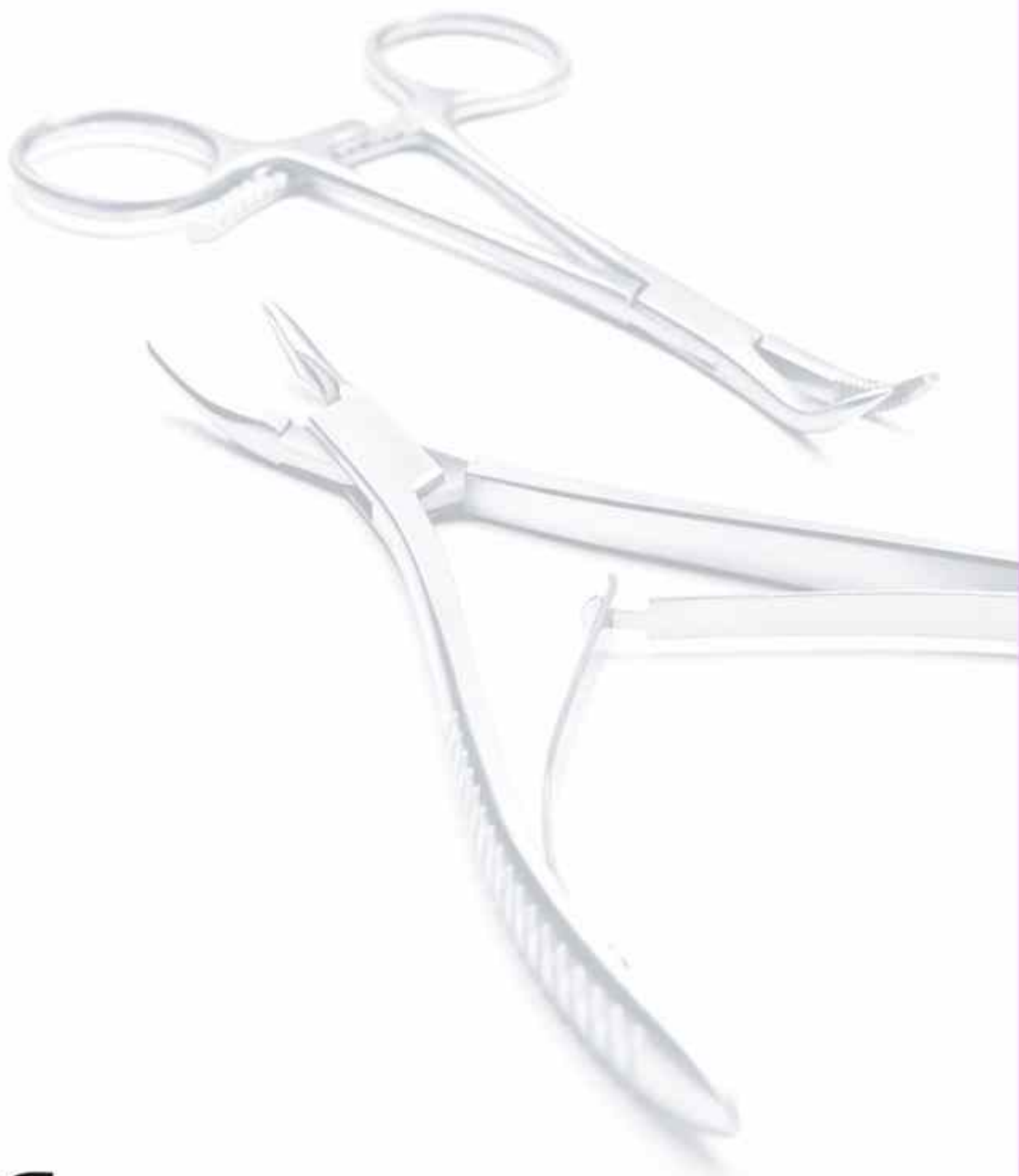

ASC Medical GmbH & Company KG  
take-off GewerbePark 2  
78579 Neuhausen o.E. | Tuttlingen, Germany

Phone: +49 (0) 7467 - 94 960 46  
Fax: +49 (0) 7467 - 94 960 49  
[www.asc-med.com](http://www.asc-med.com) - [info@asc-med.com](mailto:info@asc-med.com)